

# Preliminary Design Review

C.O.S.M.I.C – Wednesday, June 2<sup>nd</sup>, 2021



**CAL POLY**

---

# Introduction

---

---

# C.O.S.M.I.C. (Celestial Object Sensing and Measuring Identification Campaign)



**Our Team** is a dedicated engineering group of 72 Cal Poly Spacecraft Design students working cooperatively in a virtual environment.

**Our Mission** is to provide space systems for interstellar exploration to further our understanding of the origins of the solar system through the study of interstellar objects and near-parabolic comets.

# Table of Contents

## Day 1 (Wed, 6/2)

1. Introduction (2)
  1. Entrance and Success Criteria (5)
  2. Solicitation Breakdown (6)
  3. Design Challenges (9)
2. System Design (15)
3. Mission Phases (22 – 89)
  1. Phase 1 : Launch (22)
  2. Phase 2 : Orbital Insertion (37)
  3. Phase 3 : Prepositioned (44)
  4. Phase 4 : Navigation to ISO (67)
4. Closing Remarks (90)

## Day 2 Preview (Fri, 6/4)

1. Introduction (92)
2. Mission Phases Continued (96 – 148)
  1. Phase 5: Interstellar Object Flyby (96)
  2. Phase 6: Data Downlink (135)
  3. Phase 7: Decommission (145)
3. Project Life Cycle, System Integration and Testing (149)
4. Mission Budget (161)
5. Summary (164)





# PDR Entrance and Success Criteria

## Entrance

The following primary products are ready for review: A preliminary design that can be shown to meet all technical requirements and performance measures.

Life-Cycle Cost and Integrated Master Schedule (IMS) that are ready to be baselined after review comments are incorporated.

Baseline operations concept

Updated risk assessment and mitigation

## Success

The flow down of verifiable requirements is complete and proper, or, if not, an adequate plan exists for timely resolution of open items. Requirements are traceable to parent technical requirements and to mission goals and objectives

Preliminary analysis of the primary subsystems has been completed and summarized, highlighting performance and design margin challenges

TBD and TBR items are clearly identified with acceptable plans and schedule for their disposition

The preliminary design is expected to meet the requirements at an acceptable level of risk

# Solicitation Breakdown

**Goal:** To collect data on the composition, morphology, and state of an ISO (InterStellar Object) or NPC (Near-Parabolic Comet)

**Primary Objectives:** The proposed system must be able to identify at least one ISO or NPC within 20 years of the system readiness date.

- Composition
- Morphology
- Angular Momentum

**Secondary Objective Options:** The proposed system must be able to achieve at least one secondary objective.

- Impactor Science
- **Remote Observation Platform**
- **Advanced Object Definition \***
- Heliophysics Platform
- **Exoplanet Platform**
- Data Relay

**Additional Points:**

- The initial incoming ISO trajectory is **provided by the customer at 3 AU**
- **2 launches** are requested by the customer, within the 20-year mission period of 2030-2050

# Level 1 Requirements

Backup

## Primary Objectives

ID: MP = Mission Primary

ID	Traceability	Requirement
MP1	Solicitation	The mission shall be ready to react to an ISO no later than 12/31/2030.
MP2	Solicitation	The mission shall have an 80% likelihood of reaching at least 1 object with the parameters specified in Table 1 within 20 years of its readiness date.
MP3	Solicitation A.2	The mission shall acquire visible imagery of 50% of the object's illuminated surface with a resolution of at least 5.0 meters per pixel.
MP4	Solicitation A.2	The mission shall acquire infrared imagery of 50% of the object's visible surface with a resolution of at least 10.0 meters per pixel.
MP5	Solicitation A.3, Solicitation B.1	The mission shall model 50% of the object's shape within +/- 10 meters using active measurement.
MP6	Solicitation A.3	The mission shall determine the object's mean dimension within +/- 10 meters.
MP7	Solicitation A.4	The mission shall determine the object's spin axis within +/- 1.0 degree.
MP8	Solicitation A.4, Customer Conversation 5/7/2021	The mission shall determine the object's rotation rate within 1%.
MP9	Customer Conversation 1/8/2021	The mission shall return data to the customer no later than 9 months post collection.
MP10	Customer Conversation 1/8/2021	The mission shall communicate with the deep space network.



# Level 1 Requirements

## *Secondary Objectives*

ID: MS = Mission Secondary

ID	Traceability	Requirement
MS1	Solicitation B.1	The mission shall measure the object's dielectric constant within +/- <b>TBD</b> .
MS2	Solicitation B.3, Solicitation B.5	The mission shall have a sky coverage of 0.15 % in the prepositioned orbit.
MS3	Solicitation B.3	The mission shall observe heliocentric orbiting bodies.
MS4	Solicitation B.5	The mission shall acquire exoplanet photometry of a minimum of 1 star system.

---

# Design Challenges Overview

---

**Speaker:** Keilan R.

# Encounter Justification

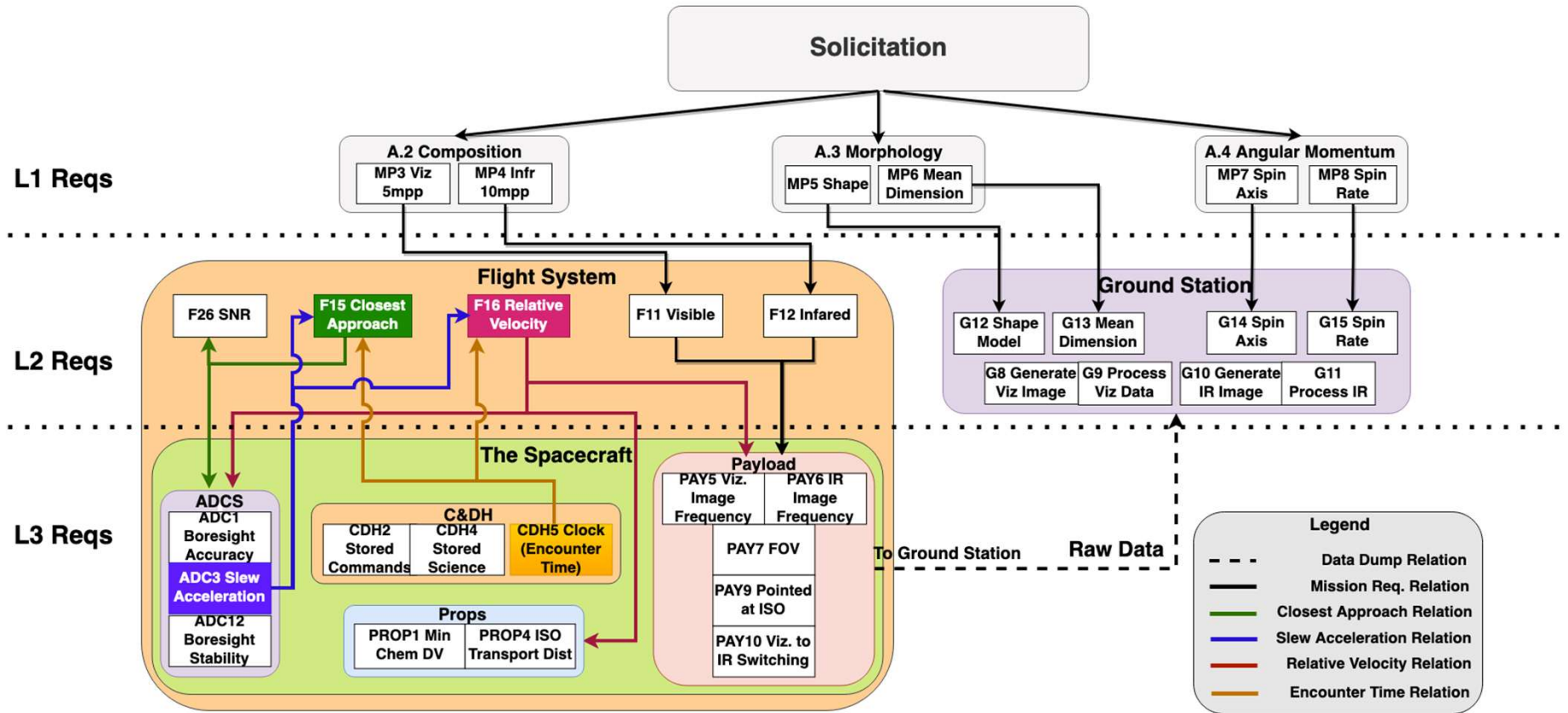

# Probability Model

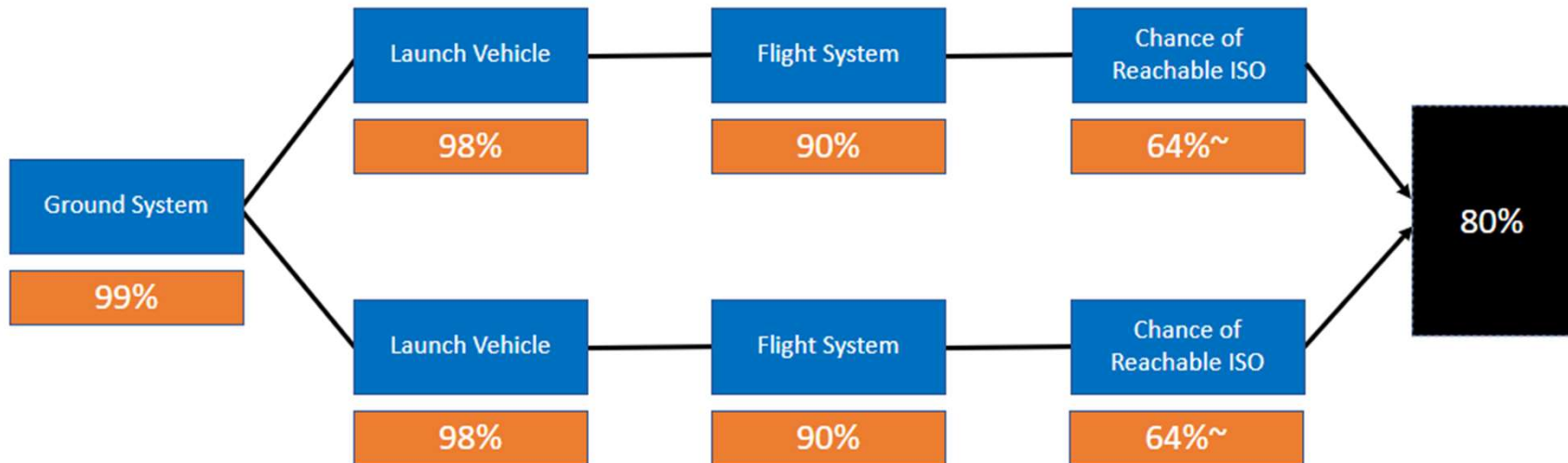

## System Level (Level 2) Reliability Block Diagram

Note: Chance of Reachable ISO is 64%~ for each S/C, equivalent to an 87%~ chance of at least one Reachable ISO between both S/C

# Flight System Reliability Model

Level 3 Reliability  
(Flight System)

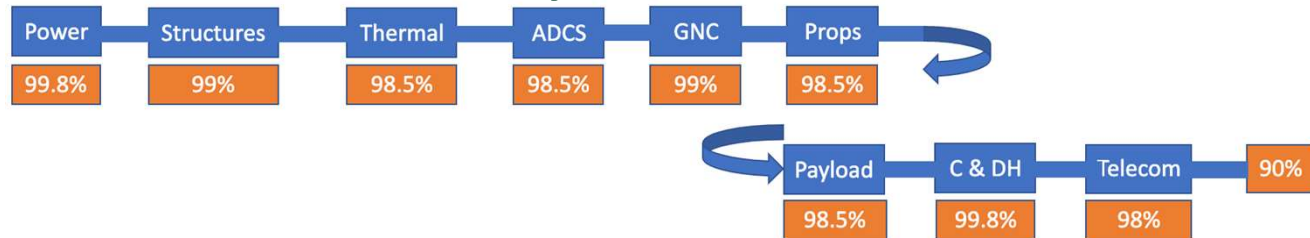

Level 4 Reliability  
(e.g., Comms)

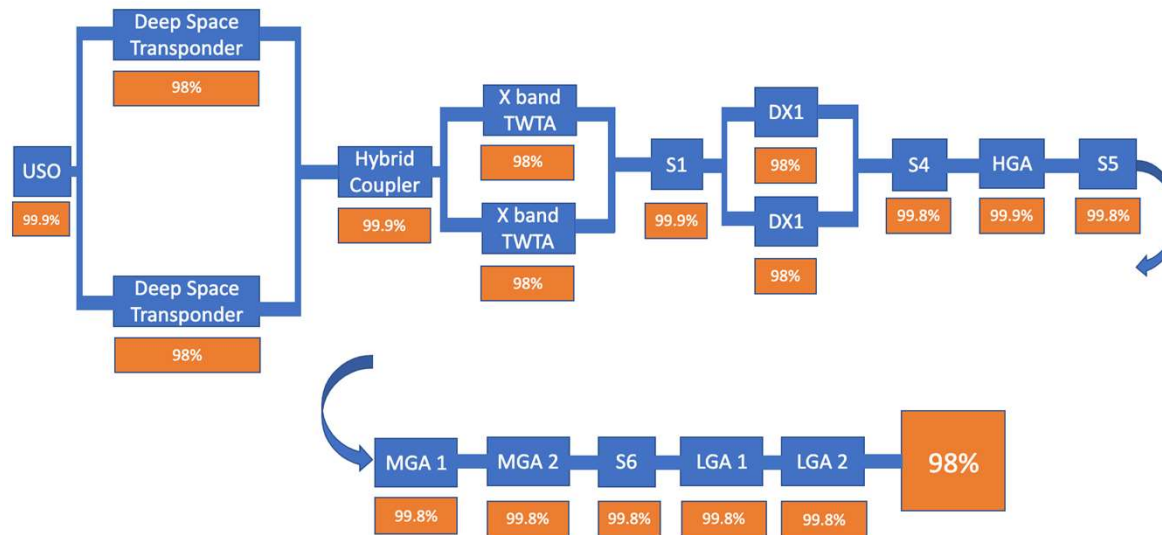



# Mission Design

- Require ISO Encounter within set parameters
- Require 87% chance of encountering ISO within 20 years
- Mission Design facilitates Encounter and ensures Coverage
  - Pre-positioned orbits chosen allow for use of Earth Gravity Assist in transfer to ISOs
- This Mission Design has an 87% chance of achieving specified ISO Encounter for a spacecraft carrying 4.5 km/s of onboard  $\Delta v$

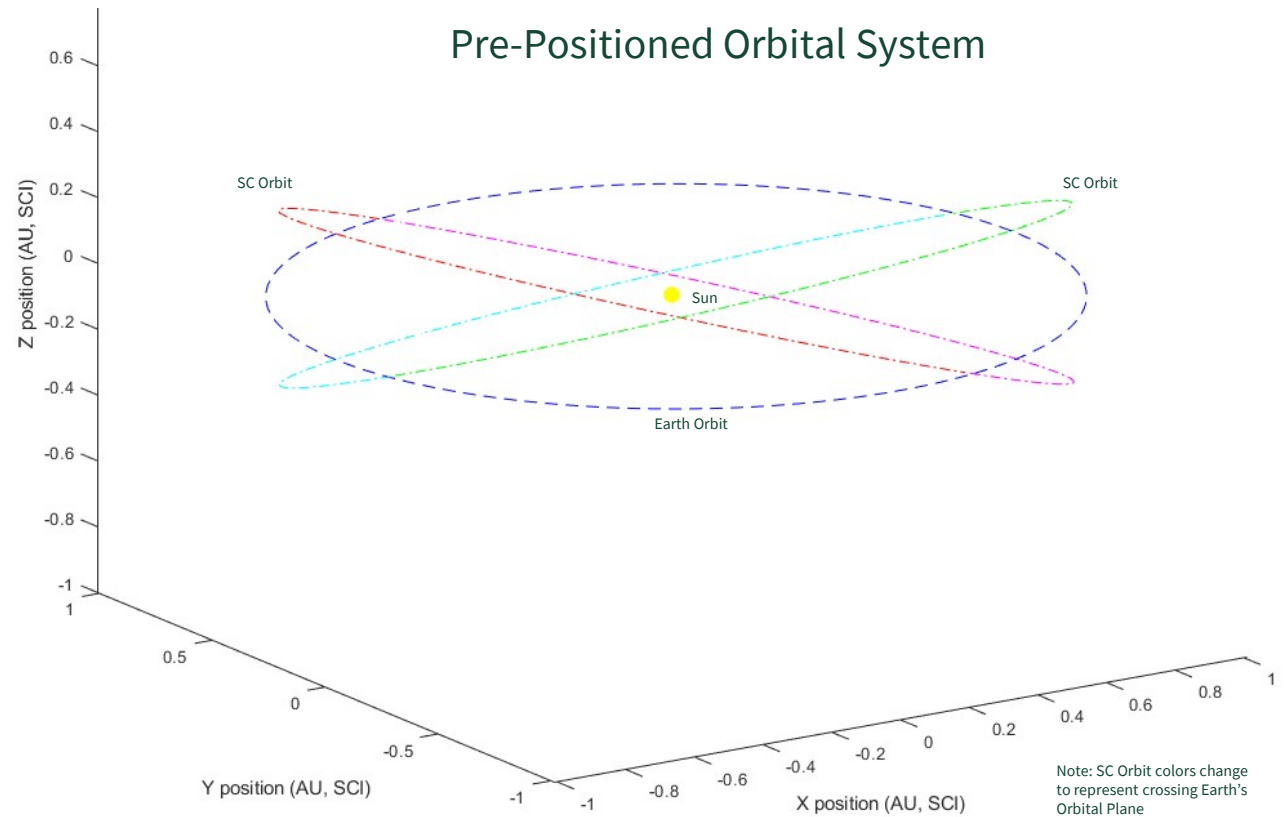

# Problem Identification – E-Prop vs. Chem Prop

## Preliminary Prepositioned System

- Large magnitudes of Delta-V (~22 km/s)
- Extended transfer durations
- Favored electric propulsion configuration

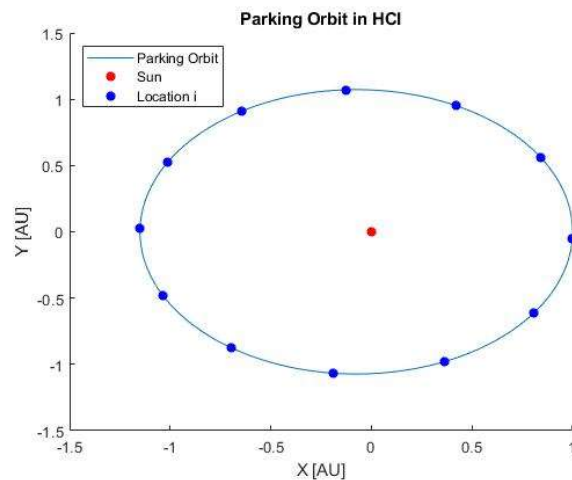

## Inclined Gravity Assist Constellation

- Earth gravity assists became necessary to achieve the required high Delta-V
- Shorter transfer durations (as low as 27 days)
- Electric propulsion configuration **not beneficial**

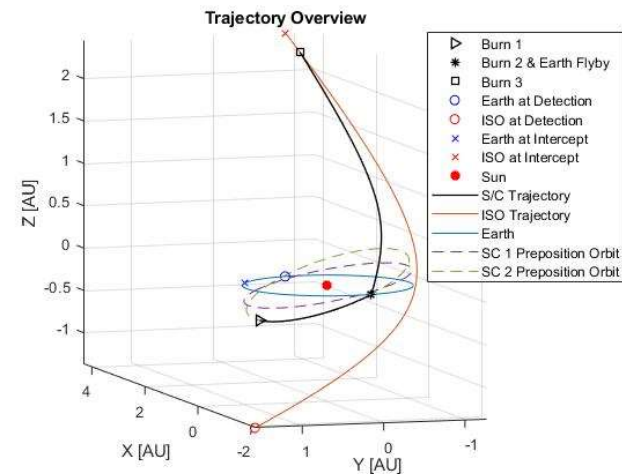

---

# System Design

---

Speaker: Sean T.



# Cal Poly Spacecraft Design 20-21

## Mission Concept Of Operations

### Phase 0

#### Pre-Launch

The launch services will transport and prepare each launch vehicle to be ready for a launch window around **October 9, 2029 and January 3, 2030**. The ground system (GS) will be prepared for launch by staffing the necessary personnel and creating software for the mission. Each S/C will also be integrated into each launch vehicle.

### Phase 1

#### Launch

The mission will launch separately out of KSC using the launch services provided by SpaceX using **two Falcon Heavy Expendables**. During launch, the GS will monitor the telemetry of the S/C. This phase will conclude when the S/C detumbles after separation from the second stage of the launch vehicle.

### Phase 2

#### Orbital Insertion

After separation from the launch vehicle, each S/C will detumble and begin communication with the ground system. The mission shall have **each S/C complete two gravity assists around Earth to increase inclination**. The final PP orbits of the spacecraft will be a circular, heliocentric orbit at **1 AU with 21 degrees of inclination, and 90 degree RAAN difference**.

### Phase 3

#### PP Orbit Waiting Period

Each of the S/C will be commanded by the GS to complete secondary objective campaigns until an ISO is pursued. **The secondary objectives attempted in this phase include remote observation platform (B.3), and exoplanet platform (B.5)**. Each S/C will be in orbit and ready to conduct objectives before 12/31/2030.

### Phase 4

#### Navigation to ISO

Upon detection of an ISO, the S/C **chosen to pursue will be commanded by the GS to leave its PP orbit on a trajectory towards an Earth gravity assist**. This S/C will then be designated as the Encounter S/C with the other S/C as the Secondary S/C. The mission will use OpNav on the way to the ISO and switch to Autonomous Optical Navigation at a distance of 55,000 km to the ISO.

### Phase 5

#### ISO Flyby

As Autonomous Optical Navigation begins, the flyby of the ISO will begin with a closest approach distance of **400 km and a maximum relative velocity of 13 km/s**. During this phase, the S/C will complete all primary objectives as well as **partial completion of the secondary objective of Advanced Object Definition (B.1)**.

### Phase 6

#### Downlink Data

Once the ISO is out of range of the S/C, **data taken during the encounter will begin to be downlinked to the GS**. All of the data must be downlinked before nine months after flyby of the ISO have elapsed. The GS will receive the data and begin processing. Once processed, the data will be made available to the customer.

### Phase 7

#### Decommission

After the primary science data has been downlinked back to the GS, the **Encounter S/C will enter the decommission phase** to be prepared for shutoff. During this time, the GS will monitor the Encounter S/C trajectory to ensure a safe graveyard orbit. The **Secondary S/C will remain in its PP orbit for a minimum of 20 years** since emplacement until decommission.

### Trajectory Legend

- Launch
- S/C into PP Orbit
- Secondary S/C into PP Orbit
- S/C in PP Orbit
- Secondary S/C in PP Orbit
- ISO Orbit
- Meeting ISO with Slow Flyby

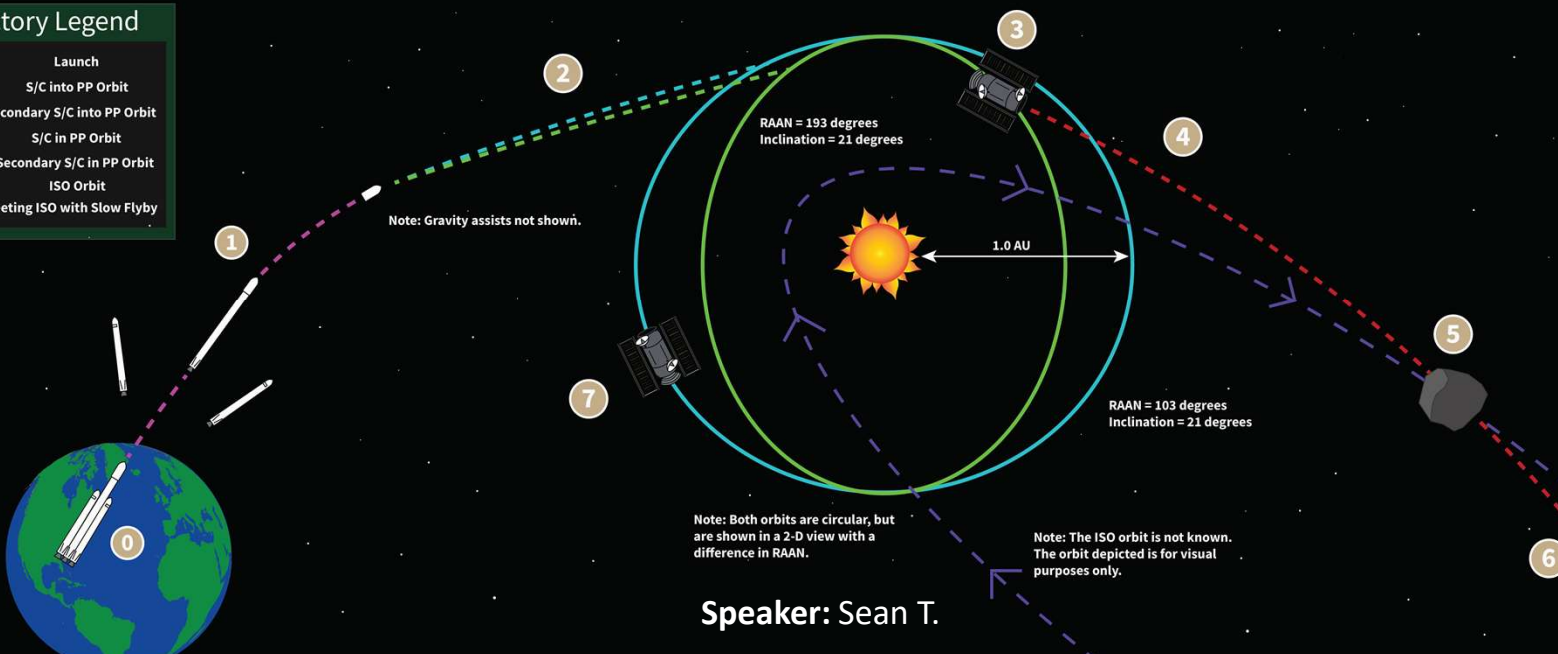

Speaker: Sean T.

# The Flight System<sub>(1/3)</sub>

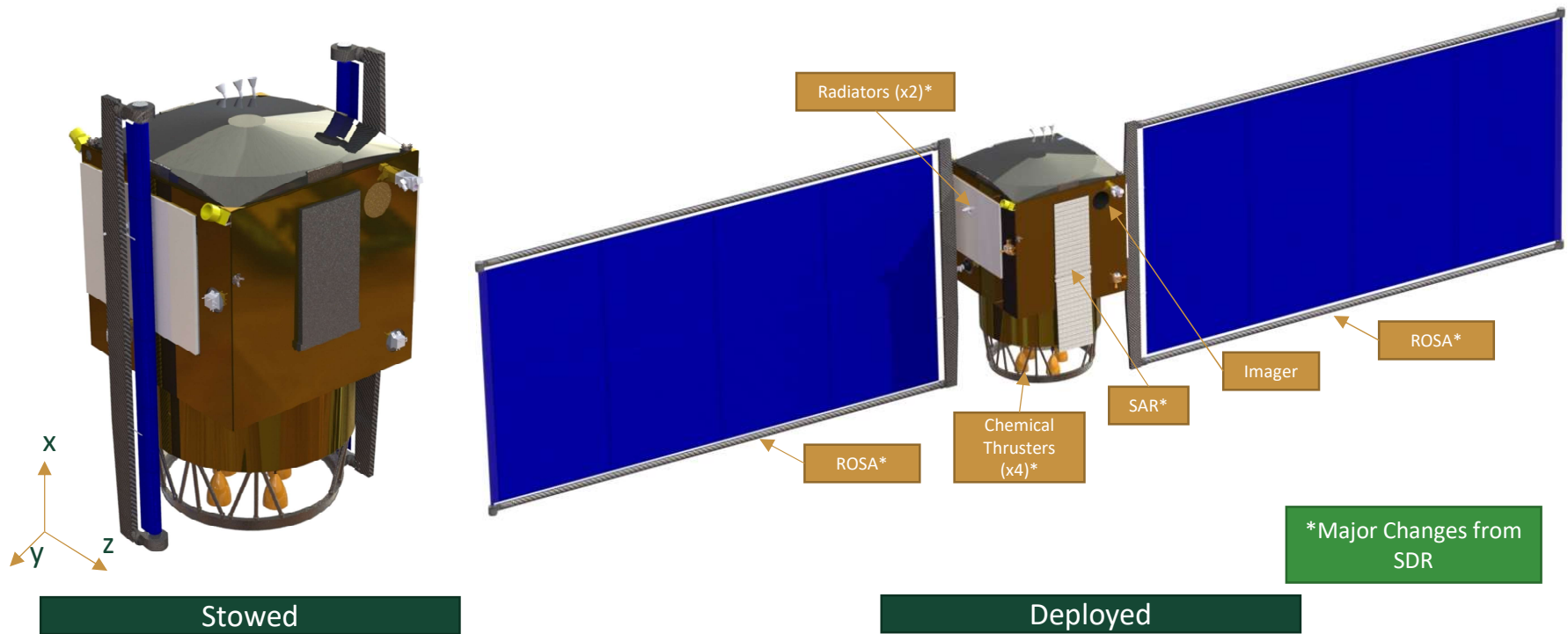

# The Flight System (2/3)

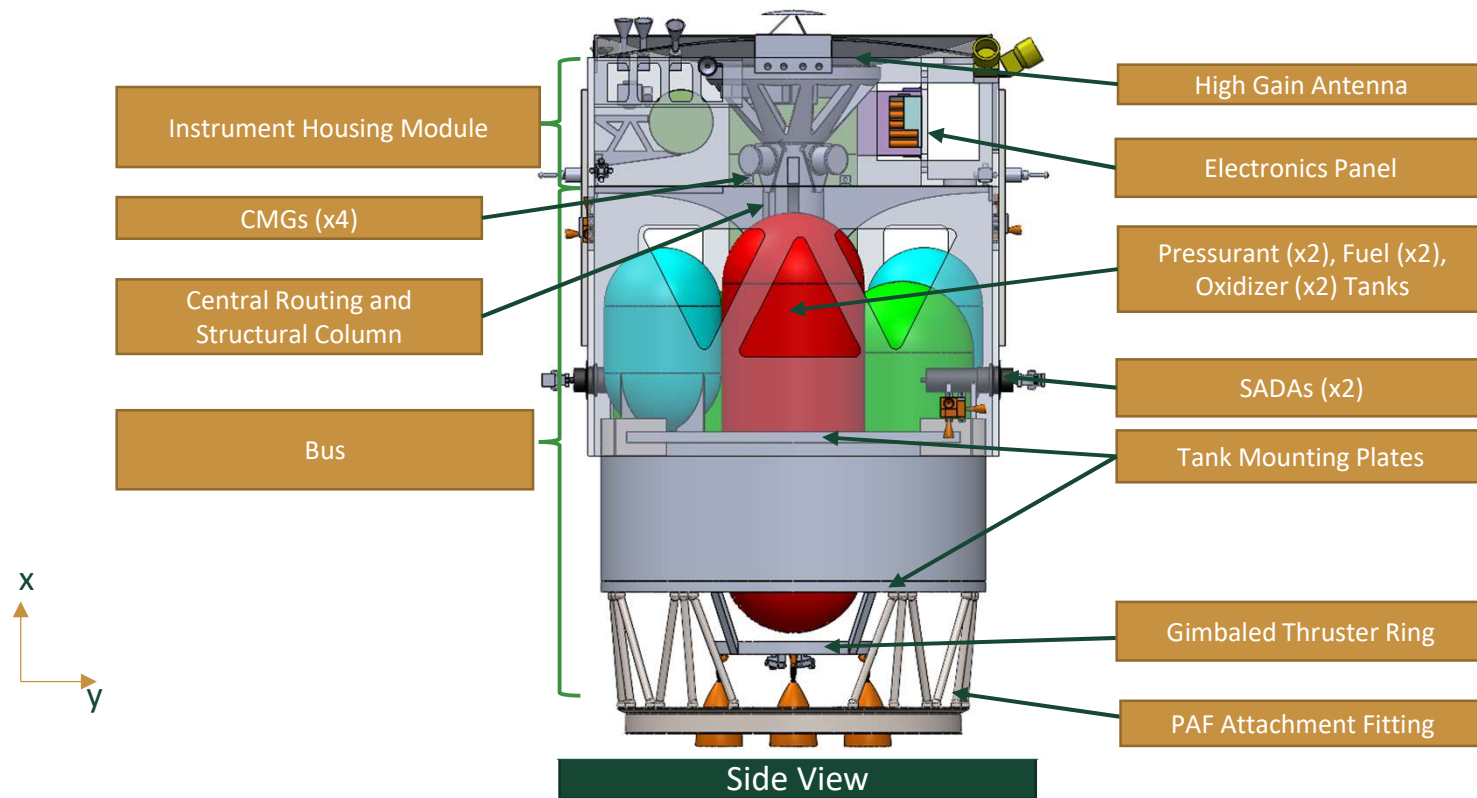

# The Flight System (3/3)

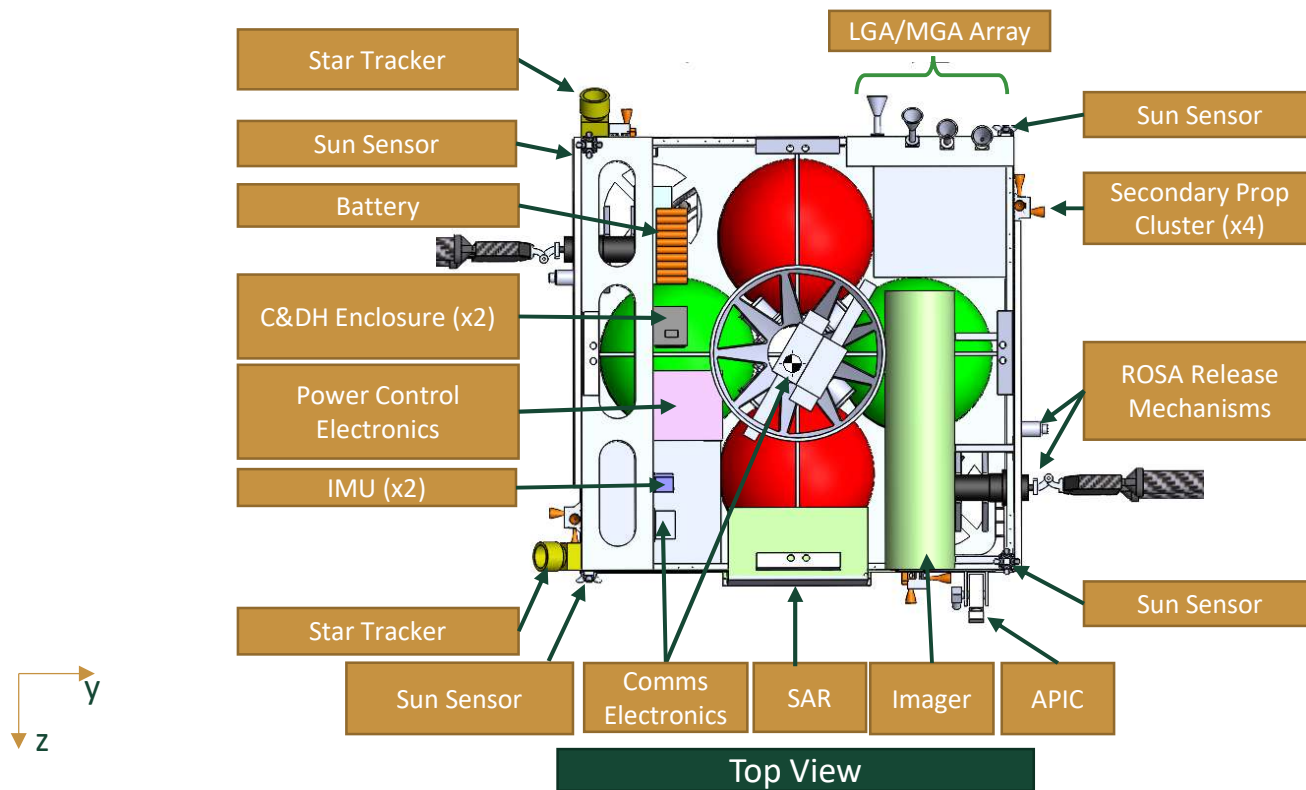



# Ground System Block Diagram

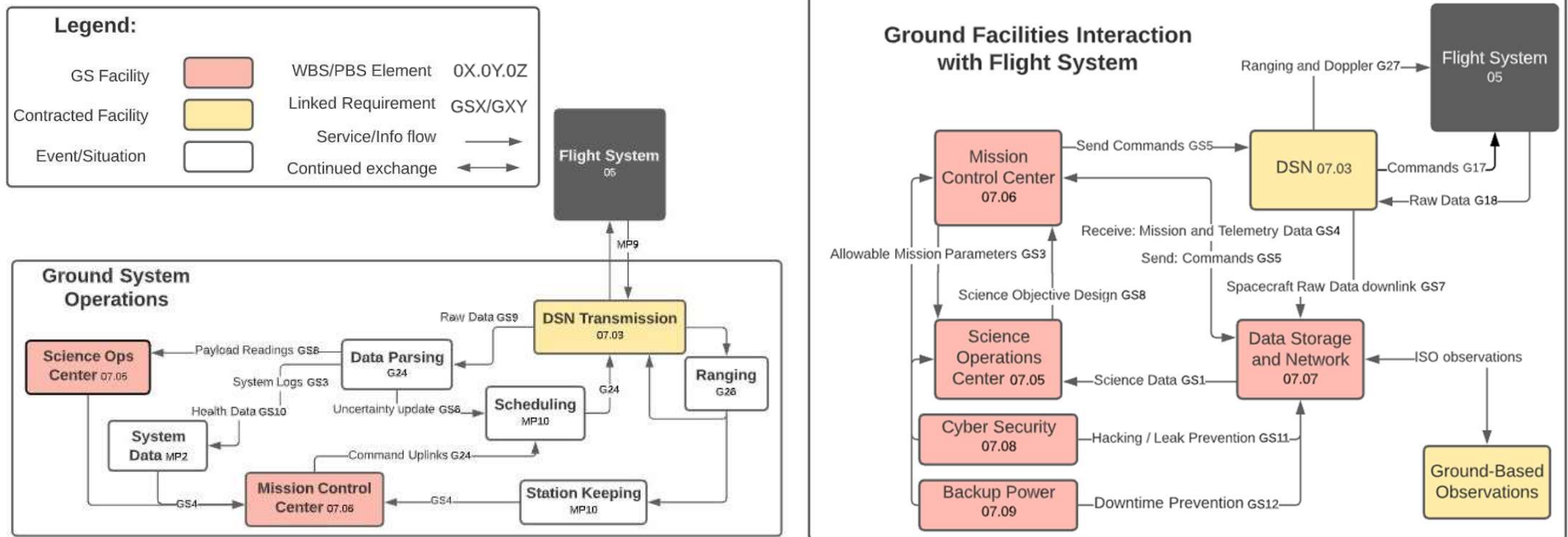



# Mass Breakdown

[Link to Backup](#)

Subsystem	Basic Mass Estimate (kg)	Mass Growth Allowance <sup>1</sup>	Predicted Mass Estimate (kg)
Payload	155	30%	202
Propulsion	657	20%	788
Power	405	20%	486
Comms	101	15%	116
Thermal	224	30%	291
GNC	5	30%	7
ADCS	72	20%	86
Structures	909	20%	1,091
C&DH	60	15%	69
Propellant	10,818	N/A	10,818

Predicted System Mass	Allowable Mass	System Mass Margin
13,953 kg	14,000 kg	0.35%

[1] "Standard: Mass Properties Control for Space Systems" *ANSI/AIAA S-120A-2015*, American Institute of Aeronautics and Astronautics, Inc., 2015, DOI:10.2514/4.103858.001

---

# Phase 1

---

Speaker: Austin I.

---

# Phase 1: Launch Overview

- **Launch Vehicle: SpaceX's Falcon Heavy Expendable**
- **First Spacecraft Launch: October 9, 2029 (2-week window)**
- **Second Spacecraft Launch: January 3, 2030 (2-week window)**
- Launch into predetermined orbit and will separate from the second stage of the Falcon Heavy
- Includes separation, detumble operations, and deployment order

# Phase 1: Launch

## *Applicable Level 2 Requirements*

ID: F = Flight System  
 ID: G = Ground System  
 ID: L = Launch System

ID	Requirement	Compliance (Y/N/M)
F4	The flight system shall survive the launch environment.	No
F6	The flight system shall have a maximum mass of 14,000 kg.	Yes
F7	The flight system shall fit within a volume of 175.15 m <sup>3</sup> with the dimensions specified in Figure 1.	Yes
F30	The flight system shall enter system fault mode in response to mission critical anomalies defined by Table 7.	Yes
G18	The ground system shall receive telemetry data from the launch vehicle.	Yes
L5	The launch system shall provide telemetry data to the ground system.	Yes
L1	The launch system shall be ready to launch no later than October 9th, 2029.	Maybe
L3	The launch system shall have a minimum reliability of 98% per launch vehicle.	Maybe

# Phase 1: Launch

## *Applicable Level 3 Structure Requirements*

ID	Requirement	Driving Phase	Compliance (Y/N/M)
STR1	The structure shall survive the launch environment as defined by the Falcon Heavy User Guide.	Phase 1	No
STR5	The structure shall survive the operational limit loads as defined by Table TBD.	N/A	Maybe
STR12	The structure shall have factors of safety defined by Table 4.3.	N/A	Maybe

# Launch Load Cases and FOS

Loading	Scenario
6G Axial	Launch
2G Lateral	Launch
Modes up to 35Hz	Launch
Random Vibrations	Launch
Deployment	Operational
Thrusting	Operational
Control Torques	Operational

## Factors of Safety

- Dependent on **materials** used
  - Metallic
  - Composite/Bonded
  - Glass/Ceramics
  - Bonds in Glass/Ceramics
  - Softgoods
  - Beryllium
- Dependent on **verification approach**
  - Prototype
  - Protoflight
- Dependent on **type** of design
  - Ultimate Design Factor
  - Yield Design Factor
  - Qualification Factor
  - Proof Test Factor

## Ex.

AL-7075, Protoflight, Yield Design -> FOS = 1.25

FOS Table

# Launch Loading Results: 6G Axial

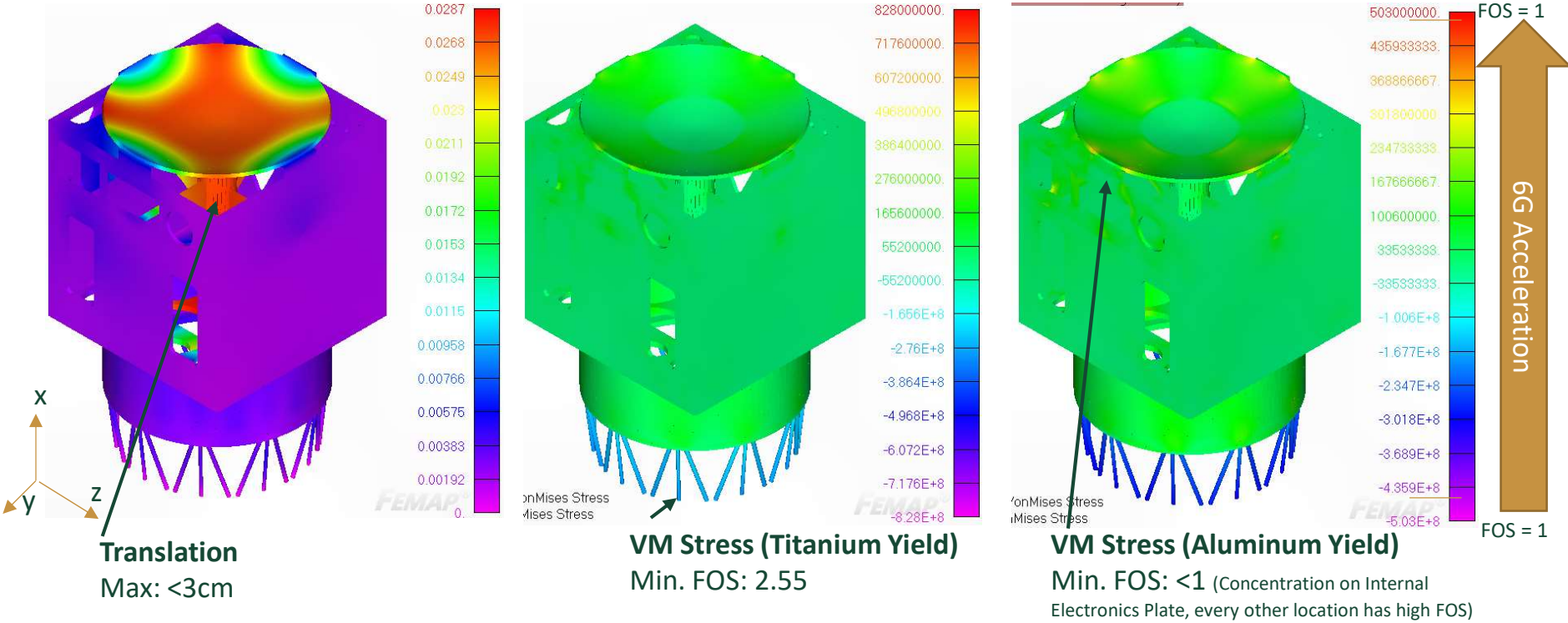

# Launch Loading Results: 2G Lateral

[Link to Detailed Analysis Backup](#)

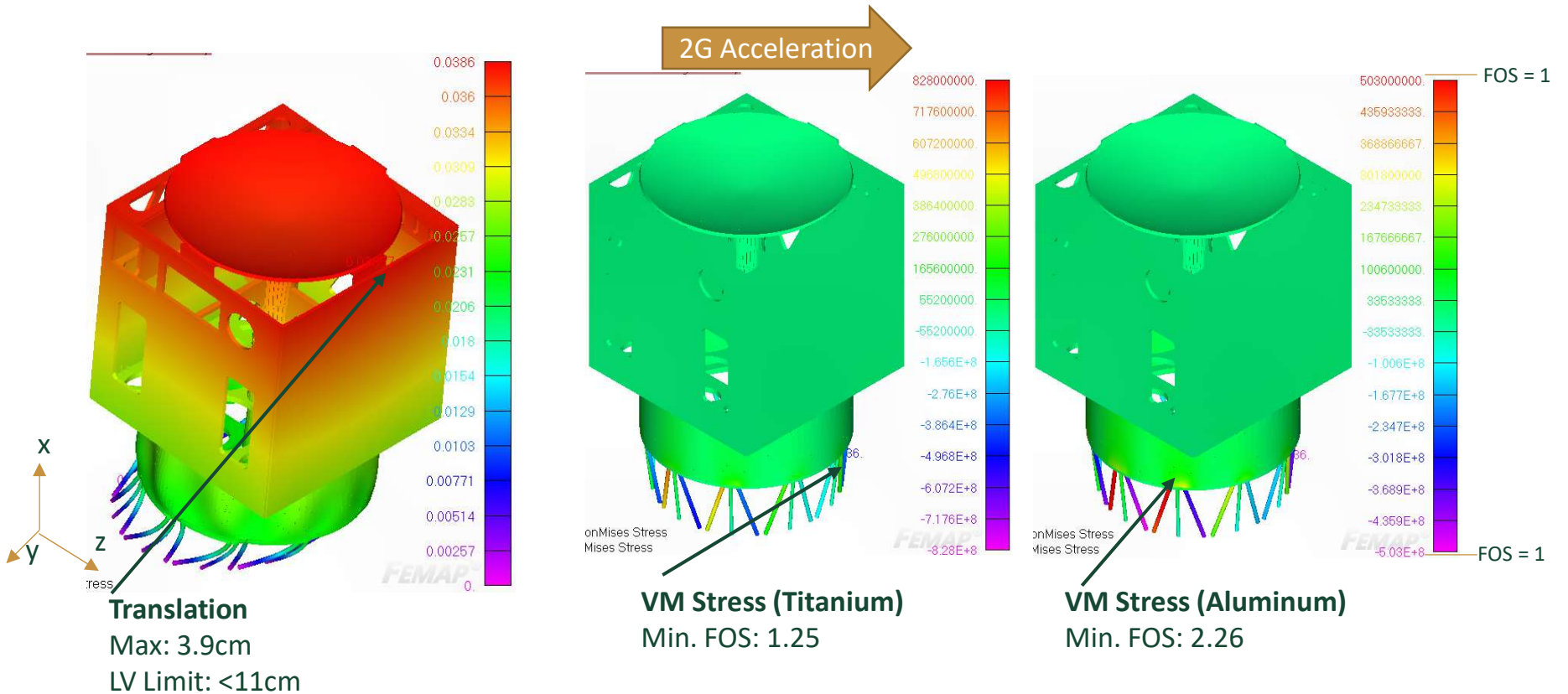



# Open Issue: Launch Modal Results

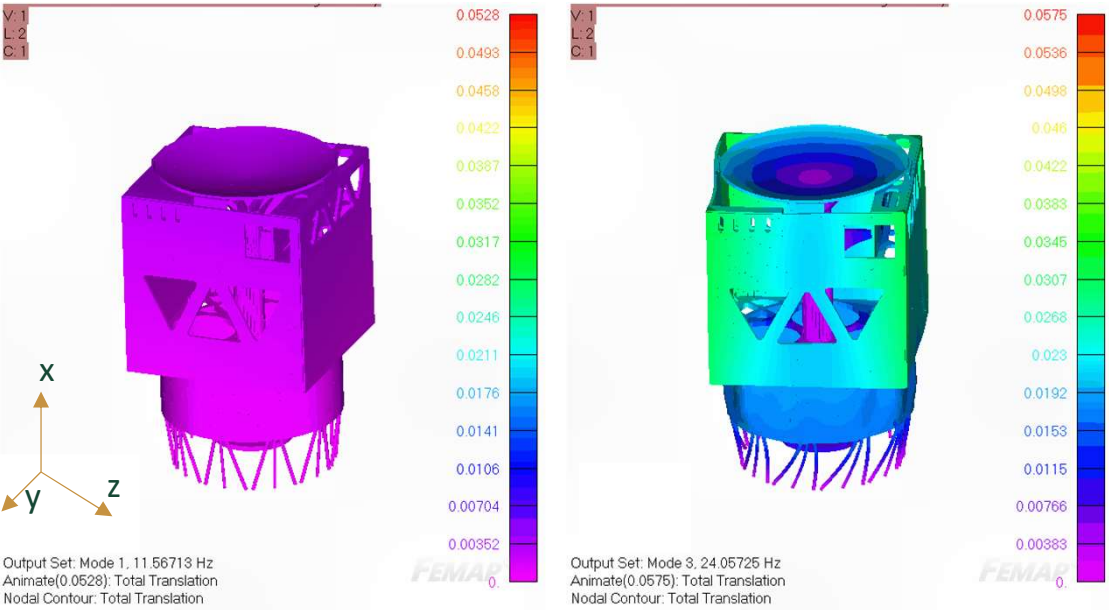

**Mode 1: 11.5Hz**  
Max Translation: 5.3cm  
LV Limit: <7cm

**Mode 3: 24.1Hz**  
Max Translation: 5.8cm  
LV Limit: <7cm

**Currently Not Meeting Launch Vehicle Requirement of under 35Hz**

**Current mass estimate: 910kg**  
**Maximum mass allocation: 1100kg**

**Routes for Improvement**

- Stiffer base beams or horizontal beams on base
- Added plate near base beams
- Internal gussets between corners of bus along plane of translation

# Phase 1: Launch

## *Applicable Level 3 Structure Requirements*

ID	Requirement	Driving Phase	Compliance (Y/N/M)
POW2	The power system shall generate a minimum of 690 Watts + TBD Watts at end of life.	N/A	Yes
F7	The flight system shall fit within a volume of 175.15 m <sup>3</sup> [TBC] with the dimensions specified in Figure 1.	Phase 1	Yes
STR7	The structure shall sense the solar array's angular position within <b>+/- 0.02 degrees</b> .	N/A	Yes
STR8	The structure shall articulate the solar arrays <b>+/- 179 degrees</b> from the zero position.	N/A	Yes

# ROSA Deployment

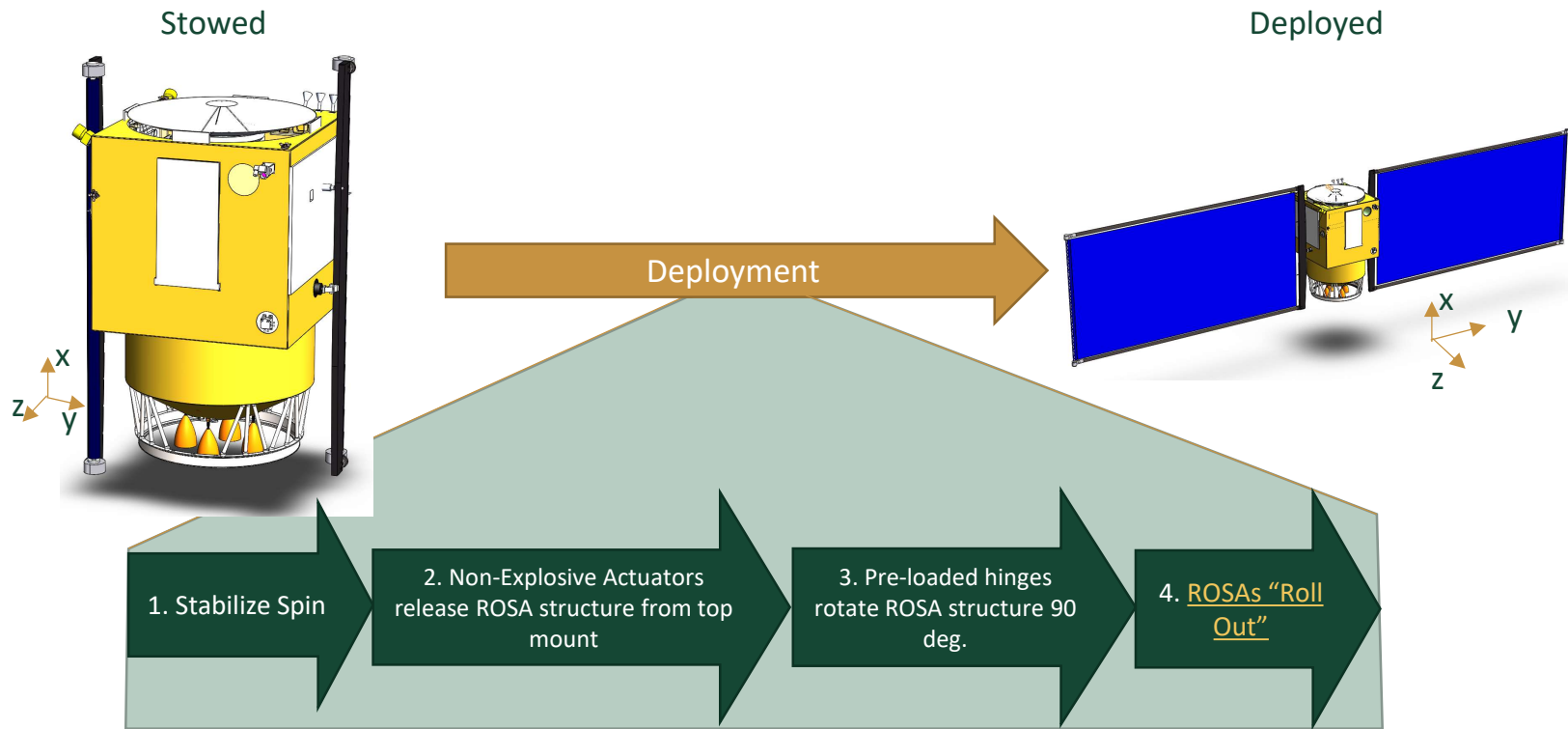

# Mechanisms - Structures

Mechanism	Source	Mass	Continuous Draw	Actuation Draw	Actuation Type	Range	Resolution	Operating Temperatures	Details
SADA (x2)	<a href="#">MOOG High Power Type 5</a>	40kg	<20W	20W	Motor	+/-179 deg.	+/-0.02 deg.	-50 C to +70 C	[1]
Roll Out Solar Arrays (ROSAs, x2)	<a href="#">DSS ROSA</a>	600 kg	N/A	N/A	Roll out	N/A	N/A	-65 C to +90 C	[3]
Non-Explosive Actuator for ROSA (x2)	<a href="#">EBAD NEA HDRM</a>	4.3kg	250 mA	4 A (release current)	Hold Down and Release	N/A	N/A	-240 C to +135 C	[4]
Deployment Hinge for ROSA (x2)	<a href="#">Deployment System for Large Appendages</a>	3kg	N/A	N/A	Spring driven	90-180 deg.	+/- .006 deg	-30C to +50 C (Survivable temperatures +/-150 C)	[5]

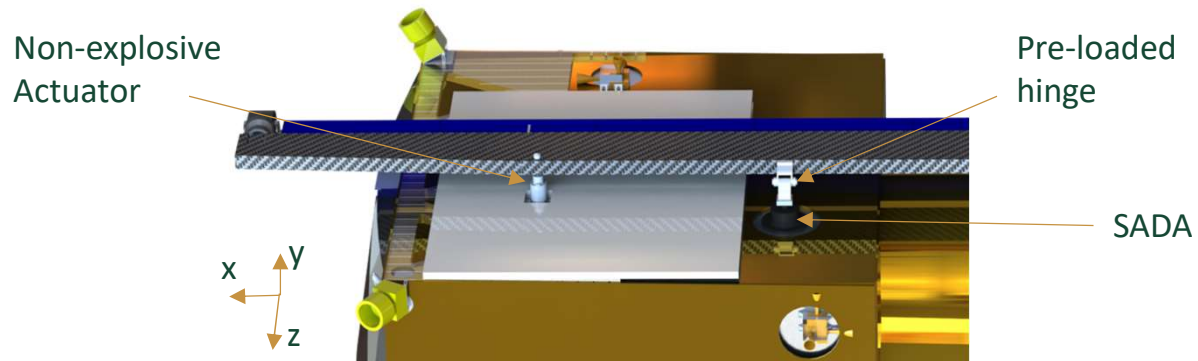

# Detumble and System Fault Mode

## Procedure (system fault mode):

1. System will turn off power for SAR, Imager, primary thrusters, Ka band travelling tube amplifiers, and APIC
2. IMUs will determine the spacecrafts inertial angular rates, using secondary thrusters to nullify angular rates
3. Once stabilized, the solar arrays will deploy
4. Sun sensors will locate the sun relative to the spacecraft
5. Solar arrays and HGA face will be positioned to point at the sun, then the solar array drives will lock the spacecraft into the sun pointing configuration
6. LGA will begin transmitting system level health data, and any secondary faults that were run
7. Secondary thrusters will rotate the spacecraft about the HGA boresight axis at 3 deg/min
8. System will await commands from ground

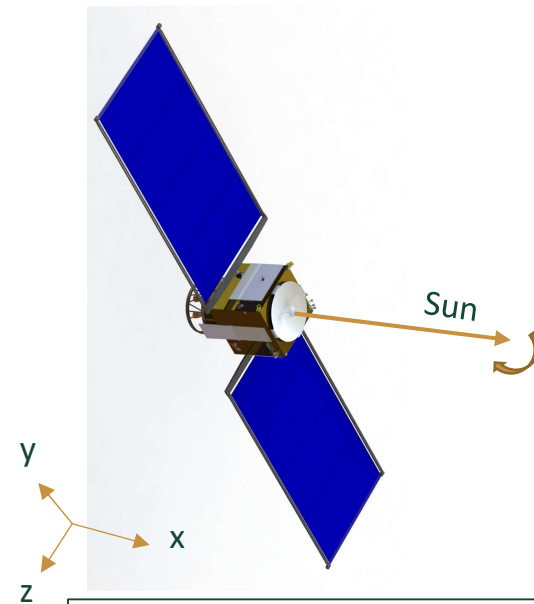

In this configuration the system will be **power positive, thermally stable** and **communication capable**.

Comm backup

Power backup

Thermal backup

# System Fault Mode

## *Applicable Level 3 Telecom Requirements*

ID	Requirement	Driving Phase	Compliance (Y/N/M)
COM18	The communication system shall transmit telemetry at a minimum data rate of 20 bps [TBC] while in system fault mode.	Phase 6	Yes
COM19	The communication system shall receive commands at a minimum data rate of TBD while in system fault mode.	Phase 6	Maybe
COM20	The communication system shall be capable of continuous transmission.	N/A	Maybe
COM20	The communication system shall be capable of continuous transmission.	N/A	Maybe
COM21	The communication system shall be capable of continuous reception.	N/A	Maybe
COM21	The communication system shall be capable of continuous reception.	N/A	Maybe

# Phase 1: Launch

## *Applicable Level 3 Power Requirements*

ID	Requirement	Driving Phase	Compliance (Y/N/M)
POW1	The power system's battery shall be capable of supplying a minimum of <b>393 + TBD Whr</b> of power before solar array deployment.	Phase 6	Yes
POW5	The power system shall provide <b>305 +/- TBD Watts</b> during system fault mode.	N/A	Yes

# Battery Schedule

## Phase 1 Detumble Timeline

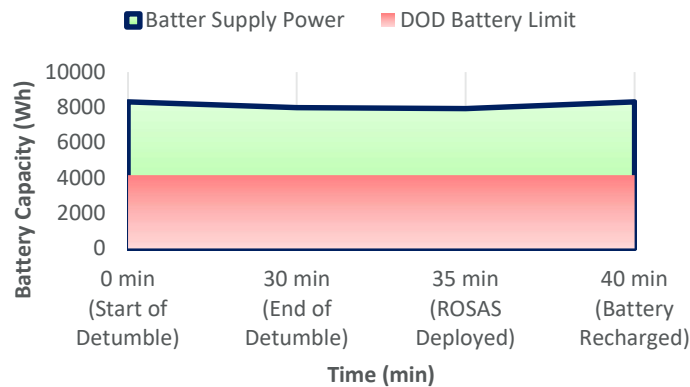

- Detumble phase is estimated to take 30 minutes at a respective system power draw of **548 W**. Given this power need the battery system is capable of detumbling for ~14 hours without array deployment.

### Initial Battery Specifications

Battery (Li-Ion)	Size (m <sup>3</sup> )	Mass (kg)	Capacity (Wh)	Cell Configuration
SAFT VL51ES	0.06892	80.4	10,452	6p10s

Subsystem	Component	Power Draw (W)	Detumbling (30 mins)	ROSA deployment (5 mins)
<b>Thermal</b>	Chem Prop Heater	150	ON	ON
	Temp feedback devices	1	ON	ON
	Pumps for Cooling	50	ON	ON
<b>ADCS</b>	CMGs (x4)	148	OFF	ON
	A-STRs (x2)	18	ON	ON
	IMUs (x2)	20	ON	ON
<b>C&amp;DH</b>	Flight Computer	95	ON	ON
	Health Sensors	5	ON	ON
<b>Structures</b>	ROSA Deployment	40	OFF	ON
<b>Propulsions</b>	Secondary Thrusters	194	ON	OFF
<b>Comms</b>	Deep Space Transponder	13	ON	ON
	Ultra Stable Oscillator	3	ON	ON
<b>Total (W) :</b>			<b>548</b>	<b>543</b>



---

# Phase 2

---

Speaker: Sean T.



# Launch to Orbital Insertion: Phase 1 and 2

## Mission Concept of Operations

Note: All orbits are circular, but are shown in a 2-D view with a difference in inclination.

Note: Only one S/C's transfer orbits depicted.

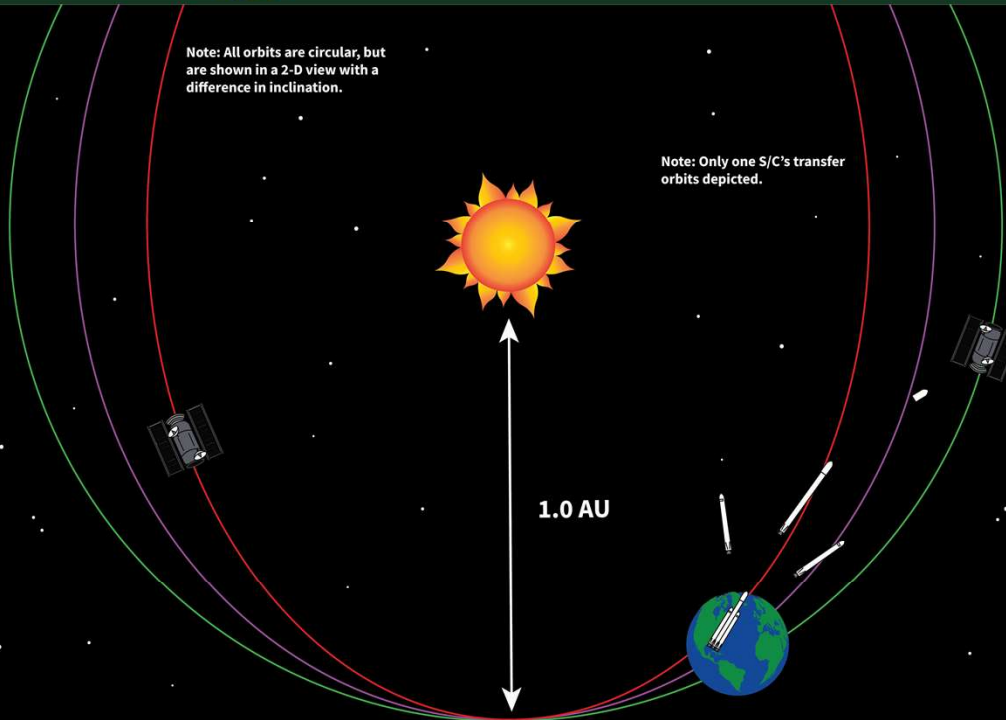

### Phase 1: Launch

Two identical S/C will be launched out of KSC three months apart using Space X's Falcon Heavy Expendable each time. Each launch will direct inject into a circular, heliocentric orbit at 1 AU and an inclination of 2.5 degrees. The first S/C launched will have a RAAN of 193 degrees and an Argument of Periapsis of 270 degrees while the second S/C launched will have a RAAN of 103 degrees and an Argument of Periapsis of 0 degrees. This phase will conclude with the detumble of the S/C after separation.

### Legend

- Final PP Orbit
- Transitional PP Orbit
- Initial PP Orbit
- Gravity Assist Trajectory

### Phase 2: Gravity Assists

Each S/C will complete two gravity assists around Earth on the way to the final prepositioned orbits to increase inclination. The gravity assists are bounded at a minimum altitude of 1000 km with each launch achieving a C3 of 2 km/s.

#### Final PP Orbit Parameters

S/C	Semi-Major Axis	Eccentricity	RAAN	Inclination	Argument of Periapsis
A	1 AU	0.0167	193°	21°	270°
B	1 AU	0.0167	103°	21°	0°

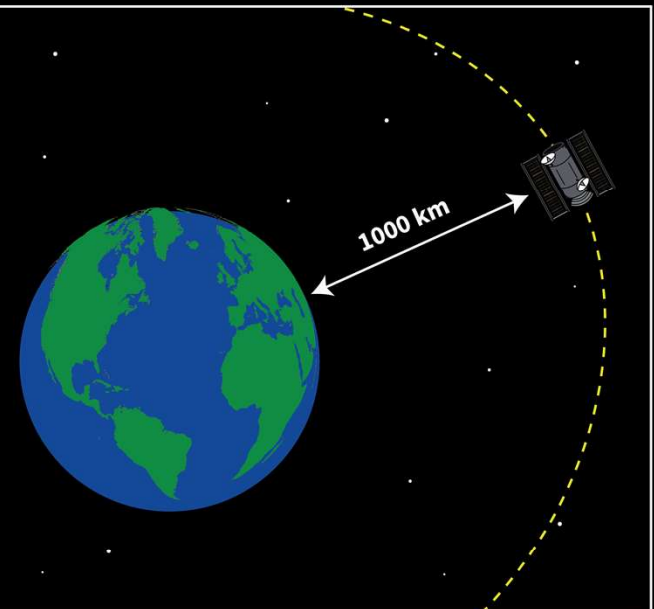

# Phase 2: Orbital Insertion

## *Applicable Level 2 Requirements*

[Backup](#)

ID	Requirement	Compliance (Y/N/M)
L2	The launch system shall deliver the flight system to an orbit defined by Table 6.1 by 12/31/2030.	Yes
L4	The launch system shall be capable of delivering the mass and C3 combinations given in Figure 2.	Yes
F22	The flight system shall be compatible with the deep space network.	Yes

# Gravity Assists - Orbits

Spacecraft	Gravity Assist/Launch Date	Orbit Inclination (deg)
A	Oct. 9, 2029	2.5
	Apr. 5, 2030	11
	Oct. 9, 2030	21
B	Jan. 3, 2030	2.5
	Jul. 8, 2030	11
	Jan. 4, 2031	21

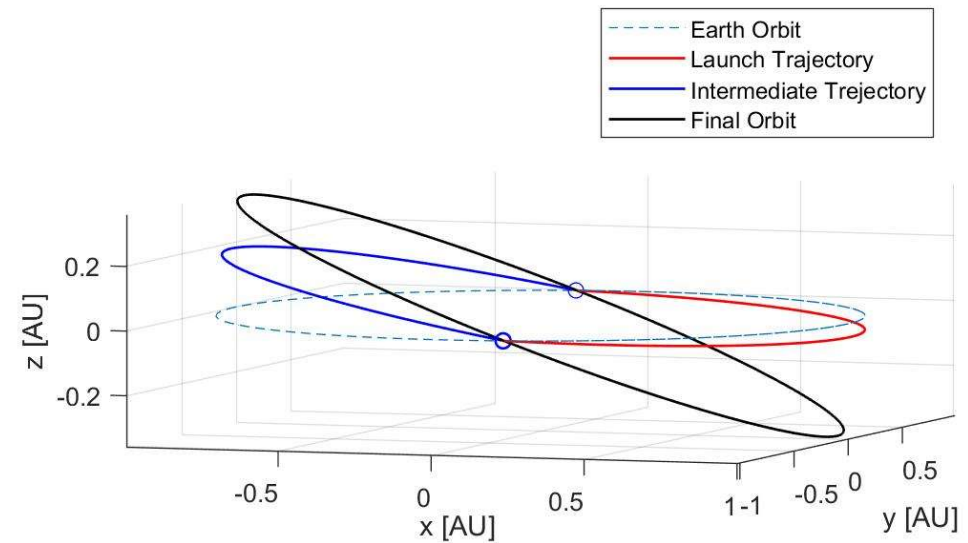

# Navigation Timeline - GNC

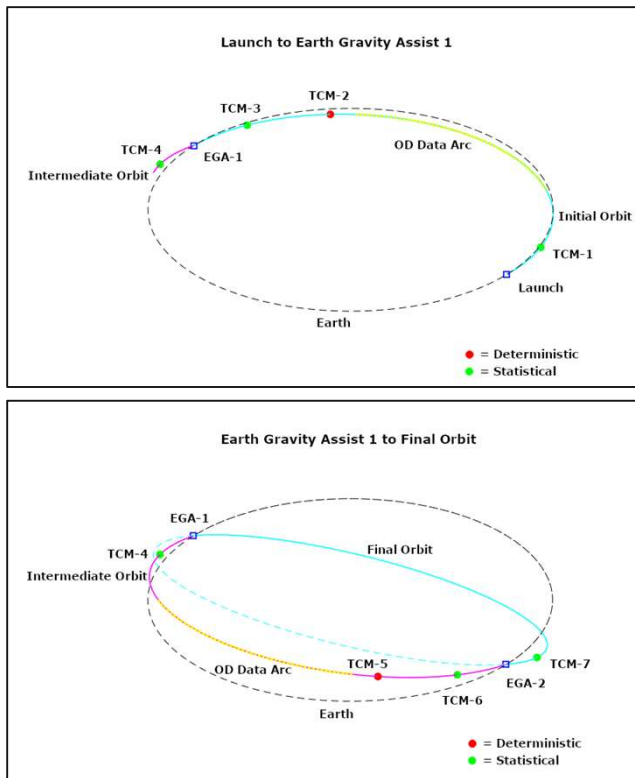

Maneuver	Date (COSMIC A   COSMIC B)	Purpose
TCM 1	July 25, 2029   October 26, 2029	Separation Cleanup
TCM 2	November 20, 2029   February 17, 2030	EGA-1 Maneuver
TCM 3	December 15, 2029   March 14, 2030	TCM 2 Cleanup
TCM 4	January 24, 2030   April 23, 2030	EGA-1 Cleanup
TCM 5	May 21, 2030   August 23, 2030	EGA-2 Maneuver
TCM 6	June 15, 2030   September 17, 2030	TCM 5 Cleanup
TCM 7	July 25, 2030   October 27, 2030	EGA-2 Cleanup

# Phase 2: Orbital Insertion

## *Applicable Level 2 Ground System Requirements*

ID	Requirement	Compliance (Y/N/M)
G33	The ground system shall establish two-way communication sessions with the flight system on <b>average of three times a week for four hours per session</b> during the orbital insertion mission phase	Yes

# Ground Operations – Orbital Insertion

- Launch Provider handles actions prior to separation, later sends data to Ground
- DSN Communication occurs at altitudes surpassing 40,000km for startup
  - Gravity assist within 1000km of Earth will be without transmission/reception
- Secondary science can begin after initial contact/setup, during emplacement
- Health checks
- Note: Startup Response procedures are the same to system fault Contingency Operations

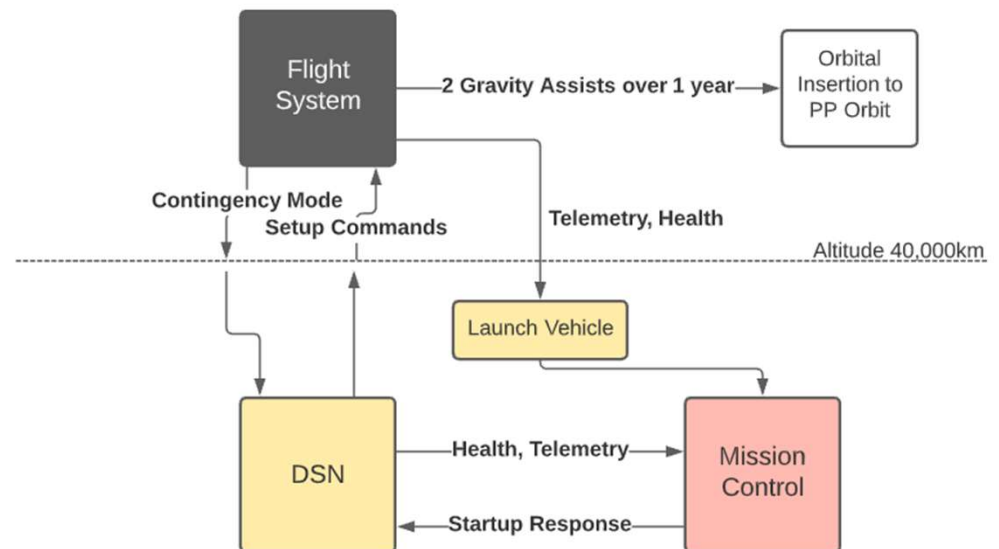

---

# Phase 3

---

Speaker: Sean T.





# Prepositioned Orbit Waiting Period: Phase 3

## Mission Concept of Operations

### B.3 Remote Observation Platform

To meet B.3 Remote Observation Platform, the S/C will observe objects for 2-4 weeks at a time. These will be follow-up observations, and will alternate with B.5 Exoplanet Platform campaigns. Images will be acquired with the primary telescope so that the target is observable with an SNR greater than or equal to 2.5, based off of known near earth objects or heliocentric orbiting bodies. These observations will provide further knowledge of the targets to the scientific community, potentially used to derive spin rates or see how their orbits change over time. The campaigns pursued will be determined by the customer.



Near-Earth Object Target

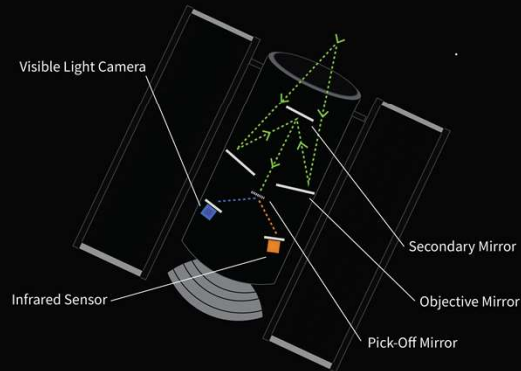

### B.5 Exoplanet Platform

To complete B.5 Exoplanet Platform, each spacecraft will perform follow-up science on known exoplanets for 2-4 weeks at a time, acquiring images every 30 minutes to build light curves that will be analyzed on the ground to look for exoplanet transits. Targets will be selected based on known exoplanets with apparent magnitude of their stars brighter than Magnitude 14.43 to ensure the transits are observable. This follow-up science will provide greater knowledge of these exoplanets and their orbital characteristics. Again, the campaign pursued will be determined by the customer.



Exoplanet Target

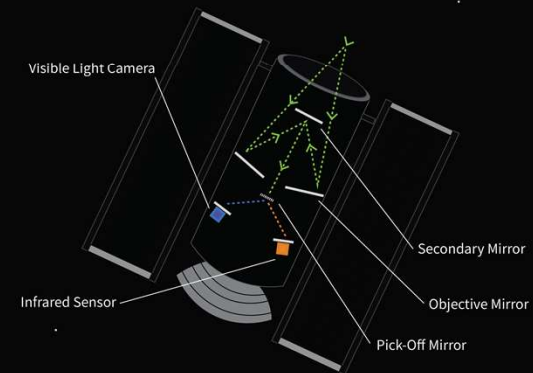

# Pre-Positioned Orbit Model

- 2 spacecraft in the orbits described in Table and shown in Figure
  - Each spacecraft has 1 Earth approach every 6 months
- Advantages
  - Gravity Assists: the system collectively has 1 potential assist every 3 months
    - This **reduces onboard DV** required by **up to 7 km/s**
    - Potential to assist station-keeping
  - Low emplacement cost: Takes advantage of assists and launch vehicle
  - Stable Heliocentric Orbit: benefits various systems e.g. Power, Comms, Thermal, Secondary Science
- Coverage
  - Over 2000 20-year missions were simulated, with Monte Carlo style analysis run on the results
  - The system as designed has **at least an 87% chance** of encountering at least 1 ISO over a 20-year mission
    - This is tied to other design factors such as propulsive capacity and relative speed at encounter

Table: PP Orbit COE					
	a (AU)	ecc	Inc (°)	$\Omega$ (°)	$\omega$ (°)
SC A	1	0.0167	21	193	270
SC B	1	0.0167	21	103	0

Figure: Prepositioned Orbits with Earth and Spacecraft positions on 3/30/31

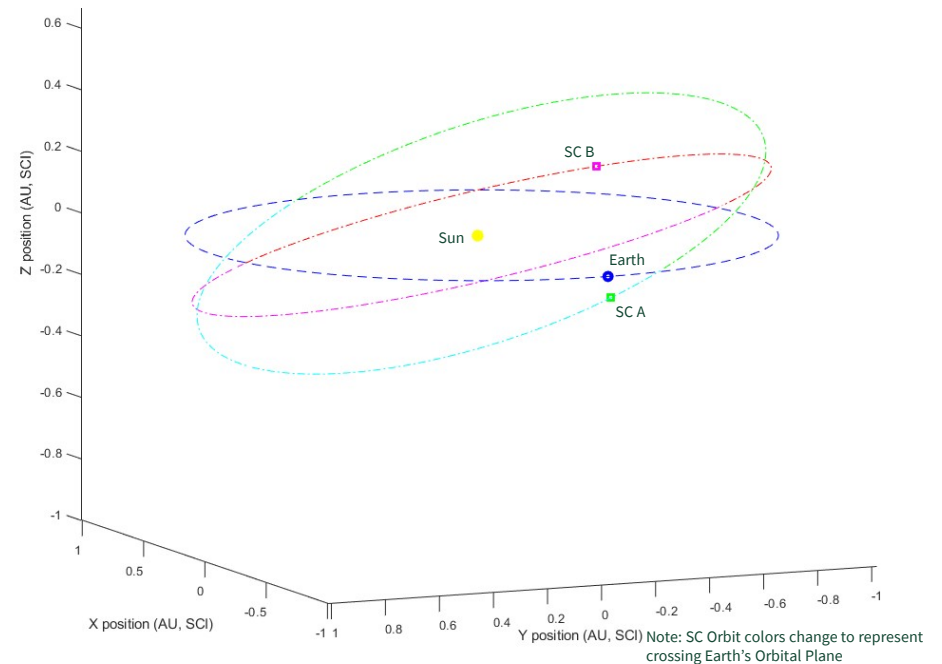

# Phase 3: Prepositioned Orbit

## *Applicable Level 2 Requirements*

Backup

ID	Requirement
F23	The flight system shall stay in the prepositioned orbit defined by Table 6.2 for a minimum of 10 months.
F24	The flight system shall observe 0.0126% of sky per month.
F25	The flight system shall detect objects with a limiting apparent magnitude of 14.5 in the visible band.
F29	The flight system shall detect objects with a limiting apparent magnitude of 12.5 in the near-infrared band.
F26	The flight system shall acquire photometry data with a signal to noise ratio of at least 2.5
F27	The flight system shall monitor one star system for at least 14 days.

# Phase 3: Prepositioned Orbit

## *Applicable Level 3 Payload Requirements*

ID	Requirement	Driving Phase	Compliance (Y/N/M)
PAY4	The payload shall be capable of taking a visible image once every 200 milliseconds.	Phase 5	Y
PAY6	The payload shall be capable of taking a visible image with an exposure time of 13 milliseconds.	Phase 5	Y
PAY8	The payload shall have an FOV of 0.55 +/- TBD degrees.	Phase 5	Y

# Science Collection – Payload

Secondary science to be conducted with [Primary Imager](#)

Remote Observation		Exoplanet Campaign	
6-month observation campaign		6 total campaigns	
Visual or IR images		Each is a 2-4 week follow-up observation using transit method	
Images taken every hour		Visual or IR images	
~8 GB of memory required		Images taken every 30 minutes	
~8 GB of memory required		~8 GB memory required	
DSN Schedule	Available Data Rate	Link Margin	Antenna
4-8 hrs per s/c per week	3 Mbps	> 5 dB	HGA

# Phase 3: Prepositioned Orbit

## *Applicable Level 3 ADCS Requirements*

ID	Requirement	Driving Phase	Compliance (Y/N/M)
ADC2	The ADCS shall point the optical boresight with an accuracy of 810 arcsec during secondary science acquisition.	Phase 3	Y
ADC4	The ADCS shall be capable of a maximum slew acceleration of <b>TBD</b> deg/s <sup>2</sup> during secondary science acquisition.	Phase 3	M
ADC5	The ADCS shall point the boresight of the high gain antenna with an accuracy of 360 arcsec during telecom.	All	Y
ADC6	The ADCS shall determine the direction of the Sun relative to the center of the solar array with an accuracy of <b>TBD</b> arcsec.	All	M
ADC8	The ADCS shall command the solar array drive assemblies to point at the Sun with an accuracy of 10 degrees.	All	Y
ADC10	The ADCS shall control the imager boresight stability to 11 arcsec/sec during secondary science acquisition.	Phase 3	Y

# Science Collection - Pointing

## Pointing Summary

**HGA:** Earth pointed for 4-8 hrs once a week to communicate with the DSN

**Solar Arrays:** Sun pointed

**Imager:** Will alternate between performing exoplanet campaign and remote observation

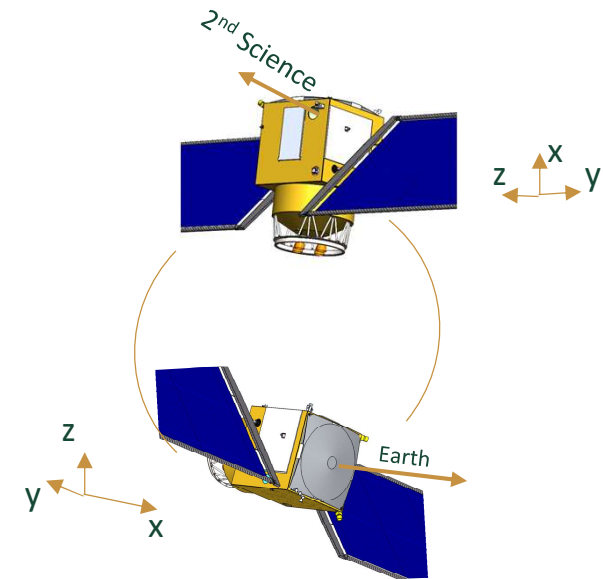

Phase 3: Prepositioned Pointing Cycle

Pointing Budget Description	Per-Axis Error Value (3 $\sigma$ ) [arcsec]	Radial Pointing Error (3 $\sigma$ ) [arcsec]	Radial Pointing Requirement [arcsec]	Stability Error (3 $\sigma$ ) [arcsec / s]	Stability Requirement [arcsec/s]
Preposition Science	189.69	201.58	810	10.81	10.81
Solar Arrays	260.30	468.54	36000	N/A	N/A
Downlink	188.30	213.66	360	N/A	N/A

# ADCS Overview

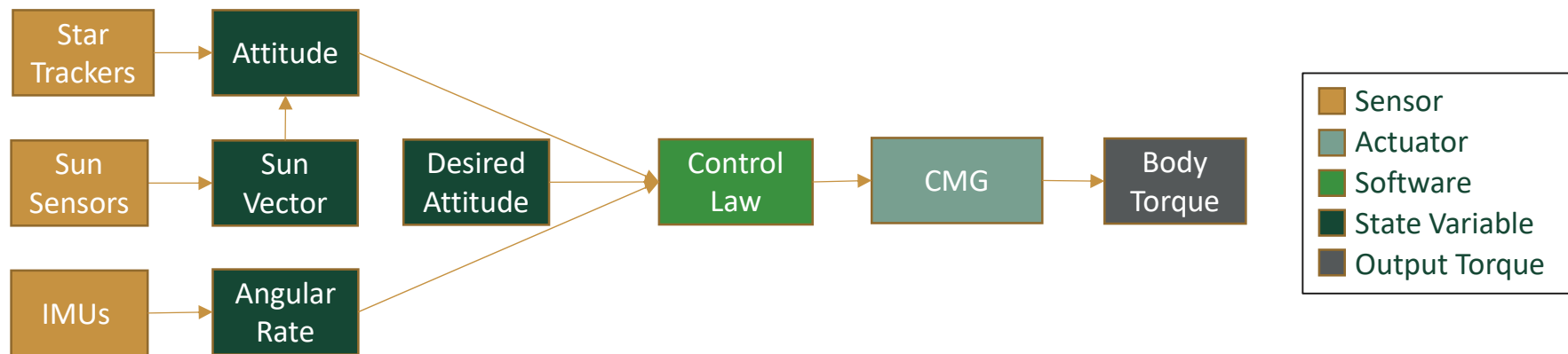

Component	Quantity	Manufacturer	Mass (Each)	Power (Each)	Performance
Star Tracker	2	Leonardo A&SS	3.55 kg	8.9 - 13 W	2°/s tracking rate
Sun Sensor	4	Bradford Space	0.215 kg	0 W (Passive)	< ±1.5 accuracy on boresight
IMU	2	InnaLabs	2 kg	10 W	Range: ± 400°/s , ± 40g
CMG	4	Blue Canyon	15 kg	20 - 35 W	12 Nm Max Torque



# Mass Memory Card Rationale

## *Applicable Level 3 C&DH Requirement*

ID	Requirement	Driving Phase	Compliance
CDH7	The C&DH system shall have a minimum storage capacity of 21 GB [TBC].	Phase 3	Yes

- PP Science data drives MMC (~16 GB), not Encounter data (~470 MB)
- Each will carry min. 21 GB
  - Additional ~5 GB health data system-wide
- Final campaign may differ
  - e.g, a 12-hour Remote Observation campaign at 5 sec cadence requires 16 GB
- Each C&DH system will have one additional MMC for redundancy (2x per system, 4 total)

Instrument, Phase	Data Storage (MB)
SAR	320.8
Vis. Imager	-
Remote Obs.	8078.4
Exoplanet*	1344
Encounter	112.2
IR Imager	24

\*one campaign; conceptual year-plan accounts for 6 campaigns

[Backup](#)

# Phase 3: Prepositioned Orbit

## *Applicable Level 3 Shielding Requirements*

ID	Requirement	Driving Phase	Compliance (Y/N/M)
STR4	The structure shall shield sensitive components from the space environment as defined by Table 4.2.	N/A	Y
THR1	The thermal system shall keep components that are turned on within their operational temperature ranges as defined by Table 3.1.	N/A	Y
THR2	The thermal system shall keep components that are turned off within their survivable temperature ranges as defined by Table 3.2.	N/A	Y
COM20	The communication system shall operate in the space environment for 22 years.	N/A	M

# Spacecraft Shielding - Structures

## MLI

- The MLI shielding is a 15 mm thick, 30 layer blanket consisting of aluminized Mylar and Dacron
- Packing density of 30 layer/15 mm was chosen to reduce conductive shorting
- High gain antenna will be covered in a germanium coated polyimide, which is RF transparent

## MMOD Shielding

- Shielding consists of honeycomb aluminum walls with 1 mm wall thickness on each side with a 5 cm honeycomb core.
- This shield can protect against particles with a critical diameter up to 1.5 cm

[Link to Detailed MLI](#)

[Link to Detailed MMOD](#)

Germanium coated kapton MLI for HGA

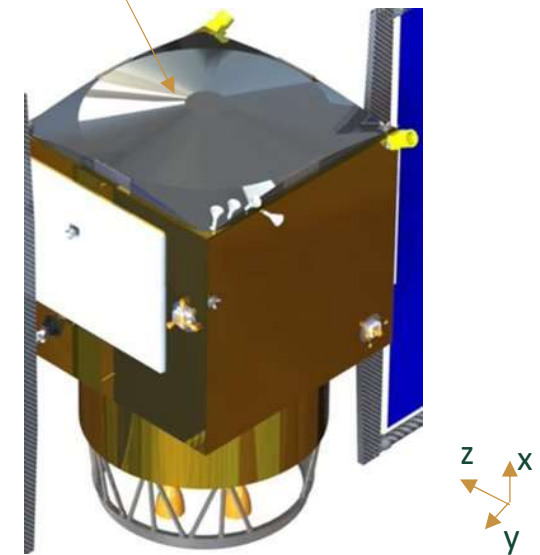

# Preposition Risks - Structures

Given that...	There is a possibility of...	Adversely impacting...	Which can result in...	Likelihood (out of 5)	Severity (out of 5)	Sub team
The exposure periods are longer than expected	The shielding not being able to withstand the exposure	The payload and support bus	The shielding degrading	1	2	Structures

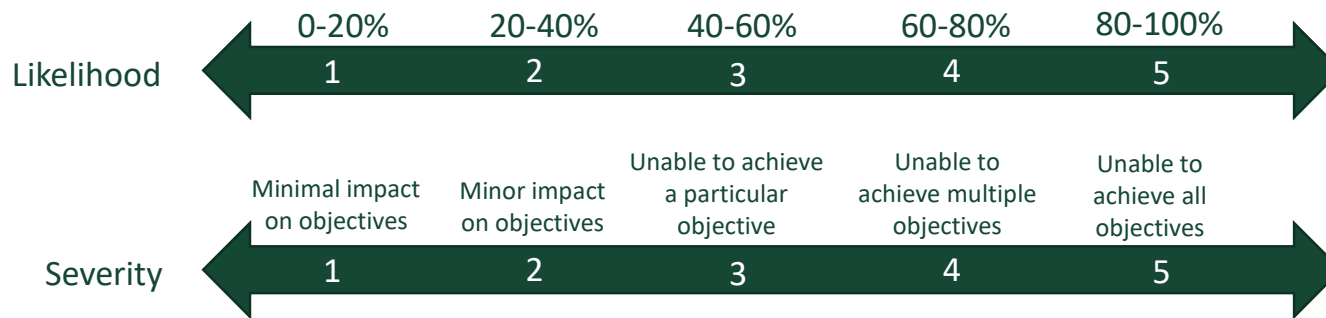

# Phase 3: Prepositioned Orbit

## *Applicable Level 3 Propulsion Requirements*

Subsystem	ID	Requirement	Driving Phase	Compliance
Propulsion	PROP2	The propulsion system shall provide the flight system with a dV of 60 +/- 15 m/s for station-keeping within the prepositioned orbit.	Phase 3	Y
Propulsion	PROP2	The propulsion system shall provide the flight system with a dV of 15 +/- 5 m/s for desaturation within the prepositioned orbit.	Phase 3	Y

# Station Keeping – Orbits & Propulsion

- Required to maintain the gravity assist schedule
- SRP (s/c only within Earth SOI for ~1.1% of orbit)
- **4wk cycle: 1wk wait, 3wk transfer**
- **0.16m/s of DV per 4wk cycle \***  
**21 years of station keeping = 45 m/s** total DV needed for the 21 years of emplacement + prepositioned orbit

Station Keeping 4wk Cycle Overview

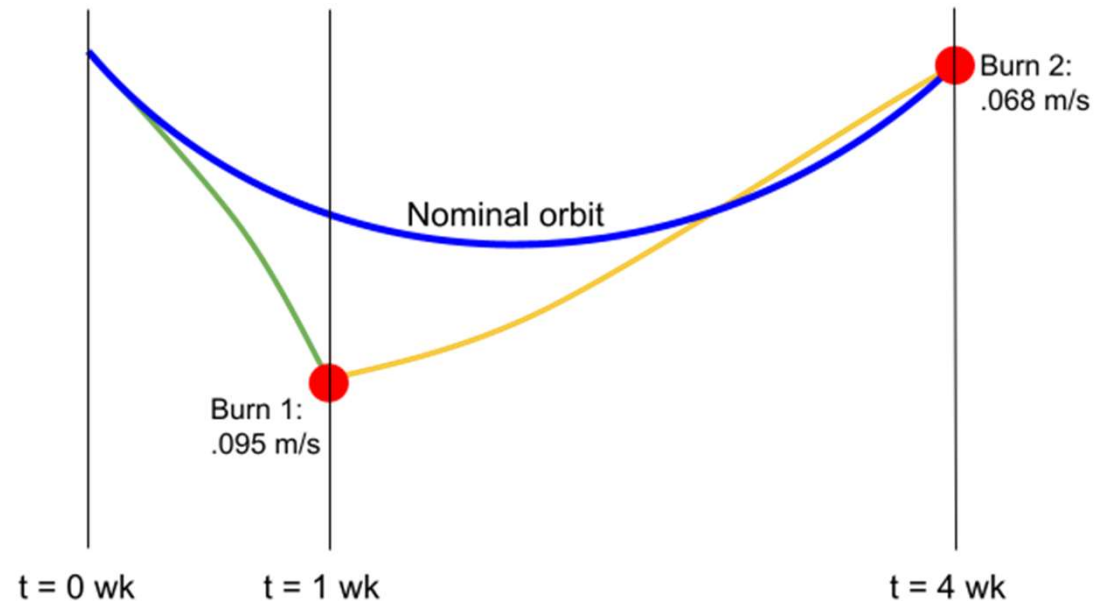

# Phase 3: Prepositioned Orbit

## *Applicable Level 3 Thermal Requirements*

Subsystem	ID	Requirement	Driving Phase	Compliance (Y/N/M)
Thermal	THR1	The thermal system shall keep components that are turned on within their operational temperature ranges as defined by Table 3.1.	N/A	Y
Thermal	THR2	The thermal system shall keep components that are turned off within their survivable temperature ranges as defined by Table 3.2.	N/A	Y

# Prepositioned - Thermal Design

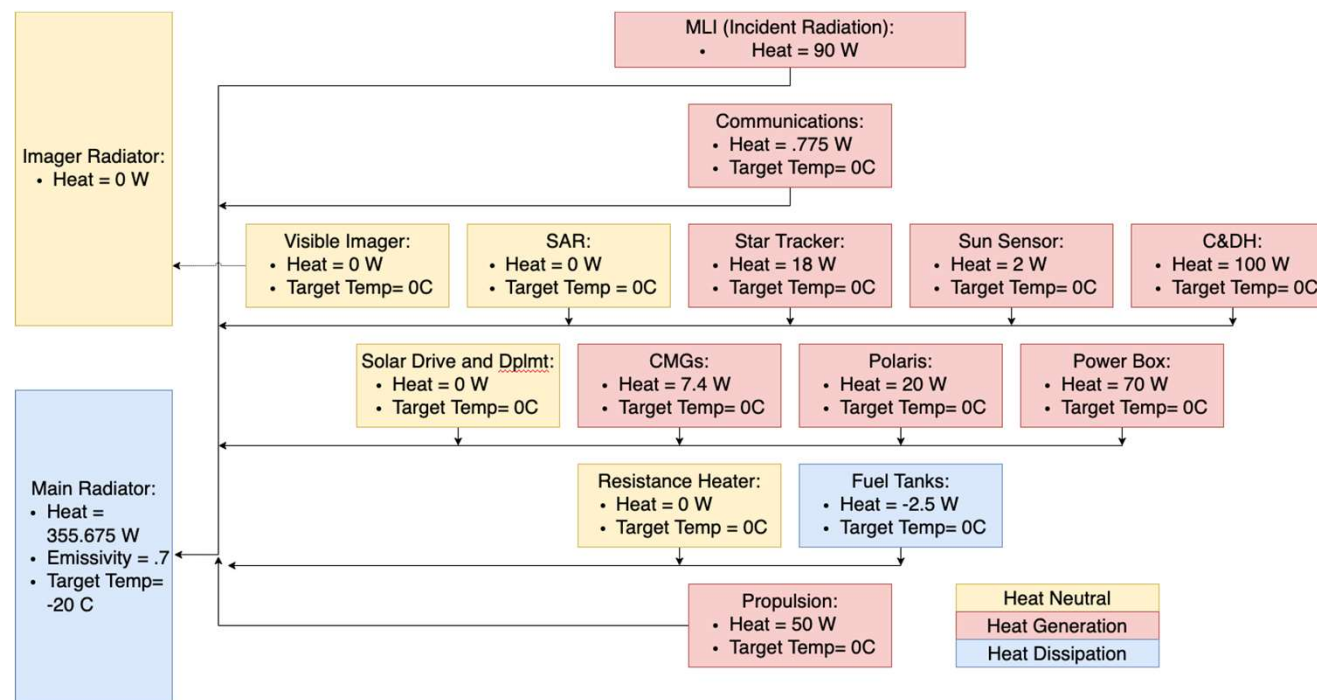

Back Up Slides



# Radiator Pointing Error Risk

Given that...	There is a possibility of...	Adversely impacting...	Which can result in...	Likelihood (out of 5)	Severity (out of 5)	Sub team
There are pointing errors which affect the orientation of the radiators	A reduction in heat rejection capability or excessive heat loads into the spacecraft	Any power consuming systems as waste heat will need to be reduced	A negative effect on the performance of the thermal system	1	3	Thermal

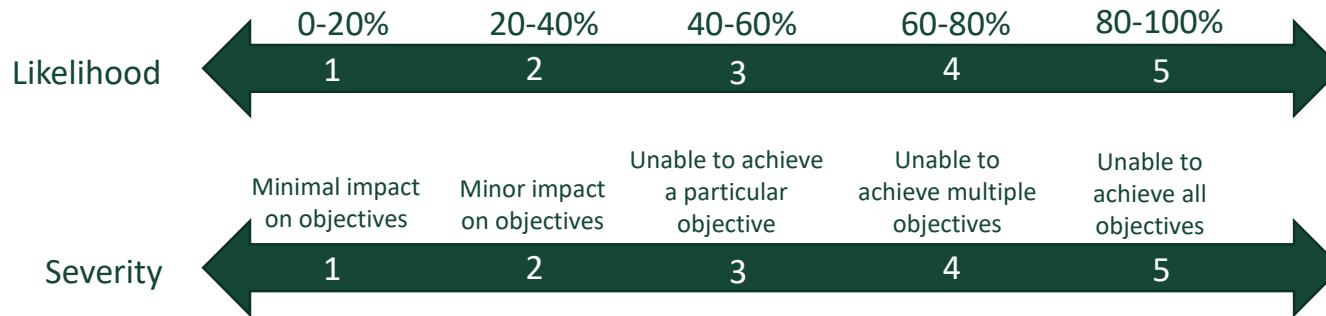

# Phase 3: Prepositioned Orbit

## *Applicable Level 3 Communication Requirements*

Subsystem	ID	Requirement	Driving Phase	Compliance
Comms	COM15	The communication system shall transmit science data with a minimum data rate of 32.4 kbps [TBC].	Phase 6	YES
Comms	COM16	The communication system shall receive commands with a data rate of up to 2 kbps [TBC].	N/A	YES
Comms	COM18	The communication system shall transmit telemetry at a minimum data rate of 20 bps [TBC] while in system fault mode.	N/A	YES
Comms	COM19	The communication system shall receive commands at a data rate of TBD bps during system fault mode.	N/A	Maybe
Comms	COM22	The communication system shall have a high gain transmission EIRP of 80.89 [TBC] dBW	Phase 6	YES

# Communication – Telecom Parameters Overview

Antenna	Quantity	Type	Frequency Band	Diameter [m]	Transmit Power [W]	Data Rate (7AU /PP)	Purpose
HGA	1	Parabolic Reflector	Ka / X	3	200 / 160	110 kbps to 3 Mbps	Science/telemetry d/l, command u/l ,ranging
MGA	2	RF Conical Horn	X	~0.15	160	25bps to 1.95 kbps	Safe Mode
LGA	2	Choked Horn	X	~0.1	160	N/A to 196 bps	Safe Mode

[Backup](#)

# Phase 3: Prepositioned Orbit

ID	Requirement	Driving Phase	Compliance (Y/N/M)
G5	The ground system shall support the flight system for a minimum of 22 years [TBC].	N/A	Maybe
G23	The ground system centers shall interface with the deep space network.	N/A	Yes
G34	The ground system shall establish two-way communication with the flight system on average of <b>once a week for four-to-eight hours</b> per session during the preposition mission phase.	Phase 3	Yes
G25	The ground system shall provide the flight system with its trajectory +/- TBD km every 14 weeks.	Phase 3/4/6	Yes
G26	The ground system shall provide the flight system with a best-fit curve of Earth's position to +/- TBD km every 1 year.	Phase 3/4/6	Yes
G39	The ground system shall process science data to provide an exoplanet science package to the customer	Phase 3	Yes
G40	The grounds system shall process science data to provide a remote observation science package to the customer	Phase	Yes

# Phase 3: Prepositioned Orbit

## *Applicable Level 3 Ground System Requirements*

ID	Requirement	Driving Phase	Compliance (Y/N/M)
GS5	The Mission Control Center shall interface indirectly with DSN via the Data Storage and Network to transmit or receive data/commands	N/A	Yes
GS3	The Mission Control Center shall design and execute commands to meet the mission demands	N/A	Yes
GS9	The Data Storage and Network shall store all data of all types locally	N/A	Maybe
GS1	The Science Operations Center shall analyze science data stored in the Data Storage and Network using science models	N/A	Maybe
GS2	The Science Operations Center shall provide science packages to the customer through the customer interface	N/A	Yes

# Ground Operations – Preposition

- Secondary Science Data Product Generation
  - Downlink → Storage → Science Product Generation → Customer
- Determination of coverage requirements for ISO intercept confirmation
- Contact Schedule: Once per week per spacecraft for 4-8hrs
  - Ephemeris Information
    - Earth, Flight System
  - Data downlink for science production
- Routine Health Checks, station keeping, course correction

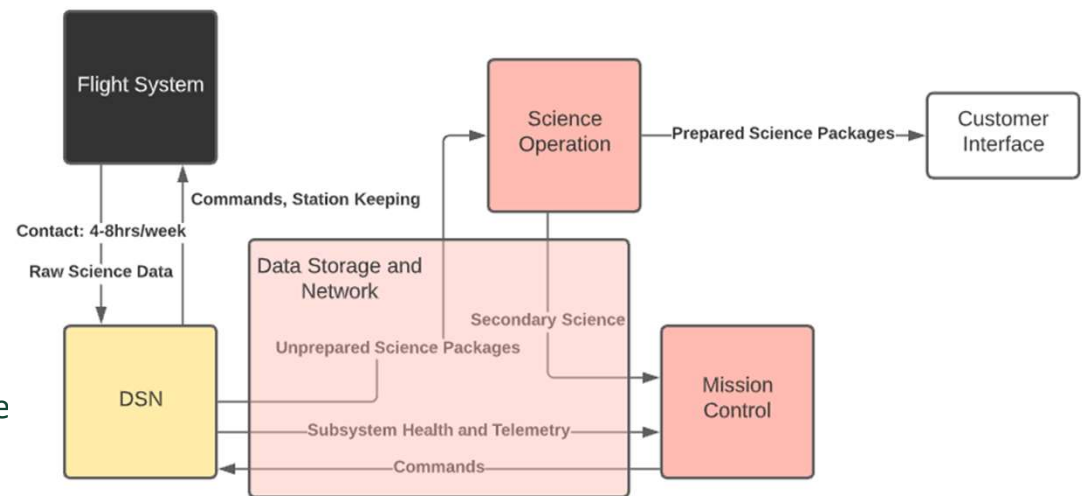

## Future Steps:

- Further analysis to determine if the ground system facilities and interfaces have a life span of at least 22 years (G4)
- Further analysis to determine total science data size and storage facility capabilities (GS9)

---

# Phase 4

---

Speaker: Austin I.

# Phase 4: Navigation to ISO - Overview

Major Event	Encounter S/C Operations	Ground System Interactions
ISO Detection and Selection	ES waits in its PP orbit for an ISO to be selected.	After an ISO is detected by a third-party, the orbital data and trajectory is provided to GS. The GS team will verify that this is a desirable ISO.
End of ISO Waiting Period	ES receives ISO data and prepares for third GA.	Three days after ISO selection, GS will communicate to ES to tell it the ISO has been selected and where it is.
Beginning of Third Gravity Assist	ES uses a burn to leave its PP orbit and a second burn to begin its third GA.	ES Leaves PP Orbit and Begins Third Earth Gravity Assist.
End of Third Gravity Assist	ES finishes third GA.	GS updates ES on its location.
End of ISO Travel	ES uses a high magnitude burn to put it on a trajectory towards the ISO.	GS updates ES on ISO location and trajectory.
ES is 55,000 km Away from ISO	ES begins using automatic optical navigation.	GS stops communicating with ES until completion of flyby.



# Phase 4: Navigation to ISO

## *Applicable Level 2 Flight System Requirements*

ID: F = Flight System

ID	Requirement	Compliance (Y/N/M)
F8	The flight system shall carry a minimum onboard dV of 4.8 km/s [TBC].	Yes
F15	The flight system shall perform trajectory corrections to achieve a closest approach distance of 400 km +/- <b>TBD</b> .	Yes
F16	The flight system shall perform trajectory corrections to achieve a maximum relative velocity to the ISO of 13 km/s at closest approach.	Yes
F28	The flight system shall transmit radiometric position signals to the ground system.	Yes
F31	The flight system shall receive trajectory updates from the ground system every <b>TBD</b> days.	Maybe

# Phase 4: Navigation to ISO

## *Applicable Level 2 Ground System Requirements*

ID	Requirement	Driving Phase	Compliance (Y/N/M)
G4	The ground system shall command the flight system to depart its prepositioned orbit.	Phase 4	Yes
G35	The ground system shall establish two-way communication sessions with the flight system <b>at least once every 36 hours for one hour per session</b> during the navigation mission phase	Phase 4	Yes
G36	The ground system shall establish a <b>minimum of 42 hours</b> of two-way communication with the flight system <b>within 2 weeks prior to the encounter</b>	Phase 4	Yes
G6	The ground system shall navigate the flight system to a closest approach distance of 400 km +/- <b>TBD</b> km.	Phase 4	Maybe
G26	The ground system shall provide the flight system with a best-fit curve of Earth's position to +/- TBD km every 1 year.	Phase 3/4/6	Yes
G25	The ground system shall provide the flight system with its trajectory +/- <b>TBD</b> km every 14 weeks.	Phase 3/4/6	Yes
G27	The ground system shall provide the flight system with the ISO ephemeris 24 hours prior to the beginning of autonomous operations.	Phase 3/4/6	Yes
G30	The ground system shall provide an ISO ephemeris with positional accuracy of +/- 20 km in all axes.	Phase 3/4/6	Maybe



# Phase 4: Navigation to ISO

## *Applicable Level 3 Ground System Requirements*

ID	Requirement	Driving Phase	Compliance (Y/N/M)
GS6	The Mission Control Center shall decide whether any customer provided ISO ephemeris meets the mission capabilities	N/A	Yes
GS3	The Mission Control Center shall design and execute commands to meet the mission demands	N/A	Yes
GS9	The Data Storage and Network shall store all data of all types locally	N/A	Maybe
GS1	The Science Operations Center shall analyze science data stored in the Data Storage and Network using science models	N/A	Yes
GS2	The Science Operations Center shall provide science packages to the customer through the customer interface	N/A	Yes

# Ground Based Observations – Ephemeris Uncertainties

- Ground based telescopes will be used to take observation sets:
- 1200 observation sets are recommended
  - 2.5 hour observation sets (30 observations spaced by 5 min)
  - Require observations 5 hours apart from detection until the ISO leaves 3AU
  - Increasing the number of observations beyond 1200 decreases allowable downtime while not decreasing ephemeris uncertainty significantly

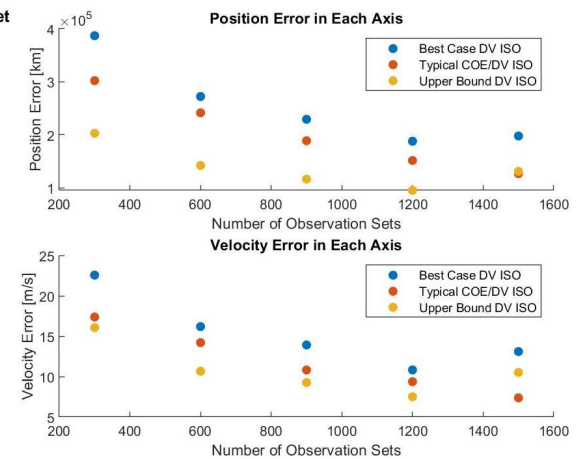
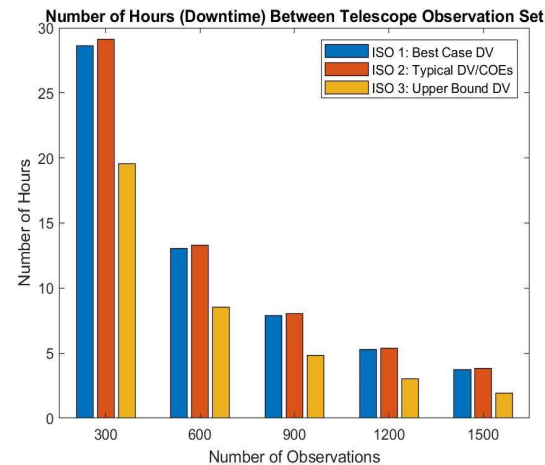

# Ground Operations – Preposition Departure to Encounter

- New Contact Schedule starts upon ISO detection
  - **One hour every 36hours** to command departure and collect/update telemetry
  - **Once daily for 2-4hrs** weeks before AutoOpNav
- New Commands Designed on ground for
  - Ephemeris of Earth, Trajectory update
  - ISO imaging procedures for pointing
- Continued Data Ground-Downlink
  - Monitor flight system status
- Prepare for AutoOpNav and GNC
  - Design burn schedule
  - Assess possible gravity assists

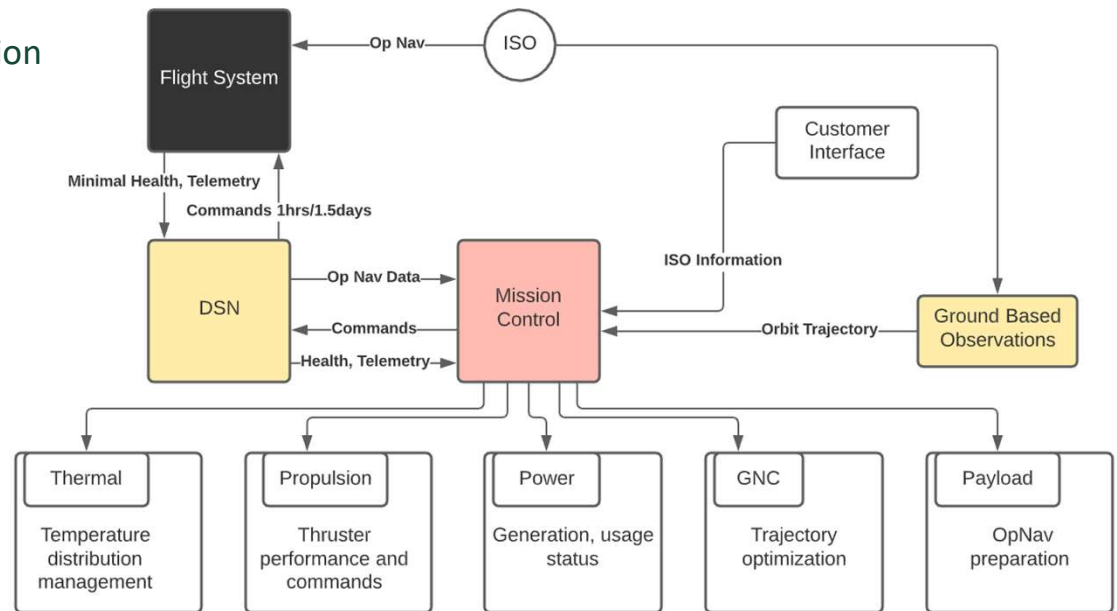

# Phase 4: Navigation to ISO

## *Applicable Level 3 GNC Requirements*

ID	Requirement	Driving Phase	Compliance (Y/N/M)
GNC1	The GNC system shall propagate the heliocentric velocity of the flight system to +/- 10 m/s in all axes for 14 days	Phase 5	M
GNC2	The GNC system shall propagate the heliocentric position of the flight system to +/- 1000 km in all axes for 14 days	Phase 2,3,4,5,6	Y
GNC3	The GNC system shall receive the heliocentric position of the flight system to +/- TBD km in all axes every 14 days.	Phase 2,3,4,5,6	M
GNC4	The GNC system shall propagate the heliocentric position of Earth to +/- 1514 km in all axes for 1 year.	Phase 2,3,4,5,6	Y
GNC5	The GNC system shall receive the heliocentric position of Earth to +/- TBD km in all axes every 1 year.	Phase 2,3,4,5,6	M

# Optical Navigation- IR vs. Visual

- Due to small ISO size, large heliocentric range, and large phase angles (angle between the ISO 2 Sun Vector and the ISO 2 SC vector), the IR sensor on the primary science imager will be used to detect the ISO at the beginning of the optical navigation campaign.
- Using IR allows us to start optical navigation earlier than if we used the visual sensor.

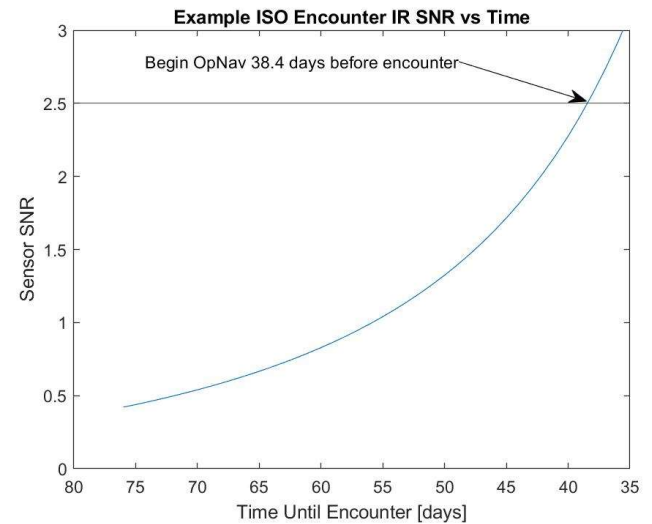
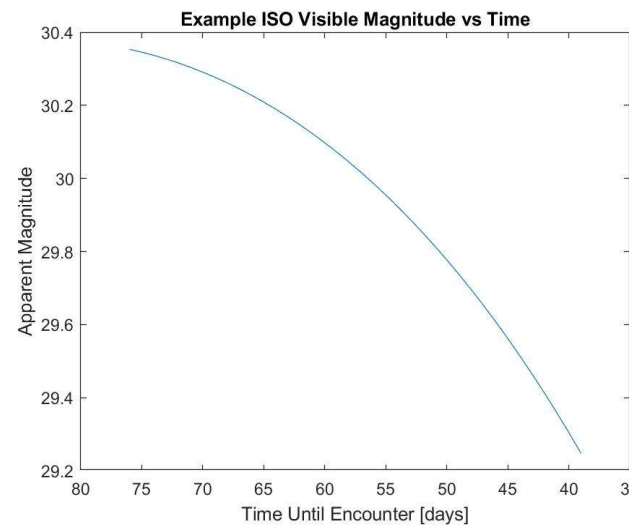

Future Work: Create model of fuel slosh during navigation to ISO, potentially add Diaphragm-style positive expulsion Pressure Management Device to fuel tanks to minimize fuel slosh

# Phase 4 Navigation Timeline

- TCM 8 and 9 compose our third Earth Gravity Assist and set us on a trajectory towards the ISO
- TCM 10-13 are additional maneuvers taken based on optical navigation data from the spacecraft to correct for uncertainty in the ISO ephemeris knowledge generated by ground systems

Event	Date (Days before Encounter)	Data Arc (#Days)
TCM 8	N/A	N/A
TCM 9	N/A	N/A
Op Nav Begins	T – 38	N/A
TCM 10	T – 18	20
TCM 11	T – 6	12
TCM 12	T – 2	4
TCM 13	T – 1	1



# Navigation Pointing Directions

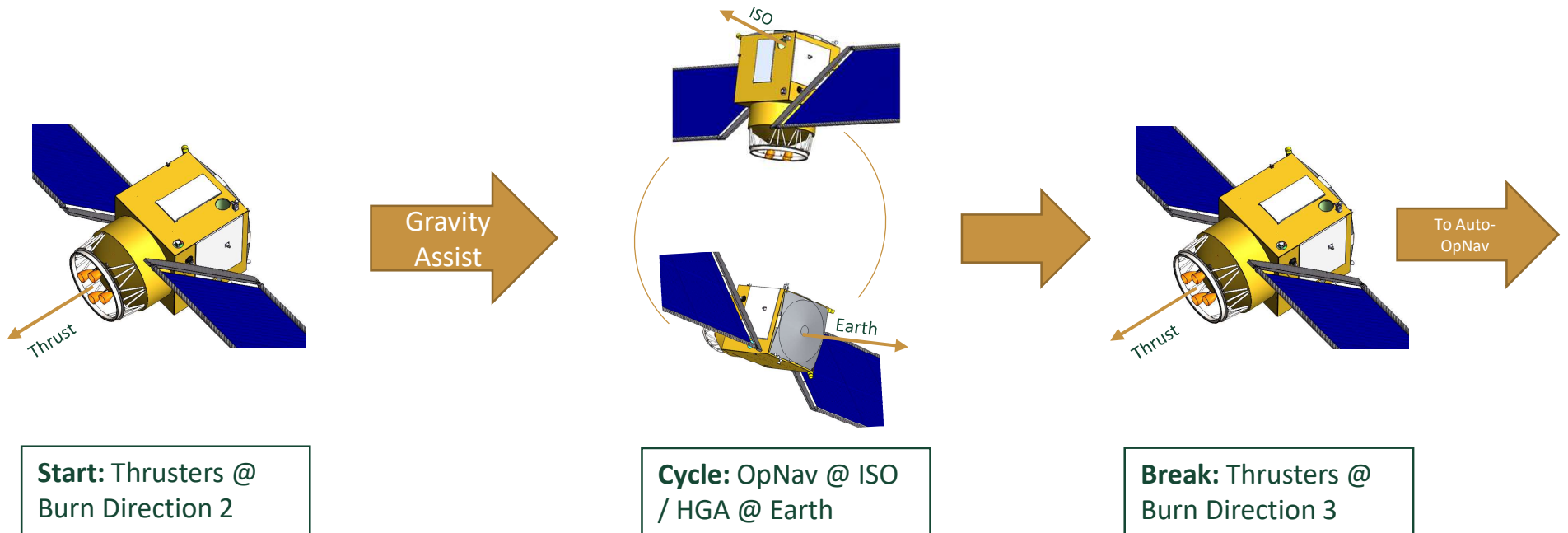

# Burn Order

## Burn 1

- 3-90 days prior to selected Earth gravity assist
- Departs from prepositioned orbit

## Burn 2

- Occurs at Earth gravity assist
- Corrects velocity vector into assist

## Burn 3

- Occurs at ISO intercept
- Reduces SC-ISO relative velocity to less than 13 km/s
- Uses remainder of propellant to make ISO intercept as slow as possible

[km/s]	Burn 1	Burn 2	Burn 3
Mean	0.10	0.10	3.86
STD	0.12	0.13	0.25

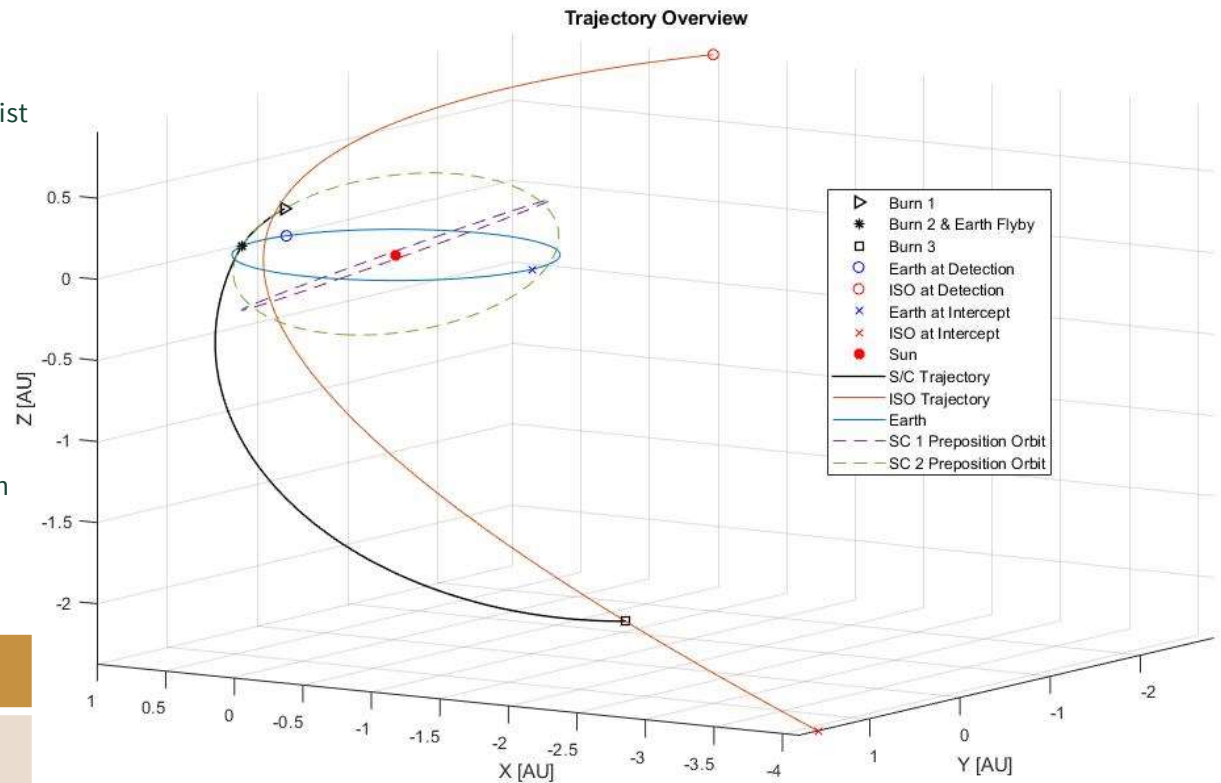

[Backup](#)

# Mass Sizing

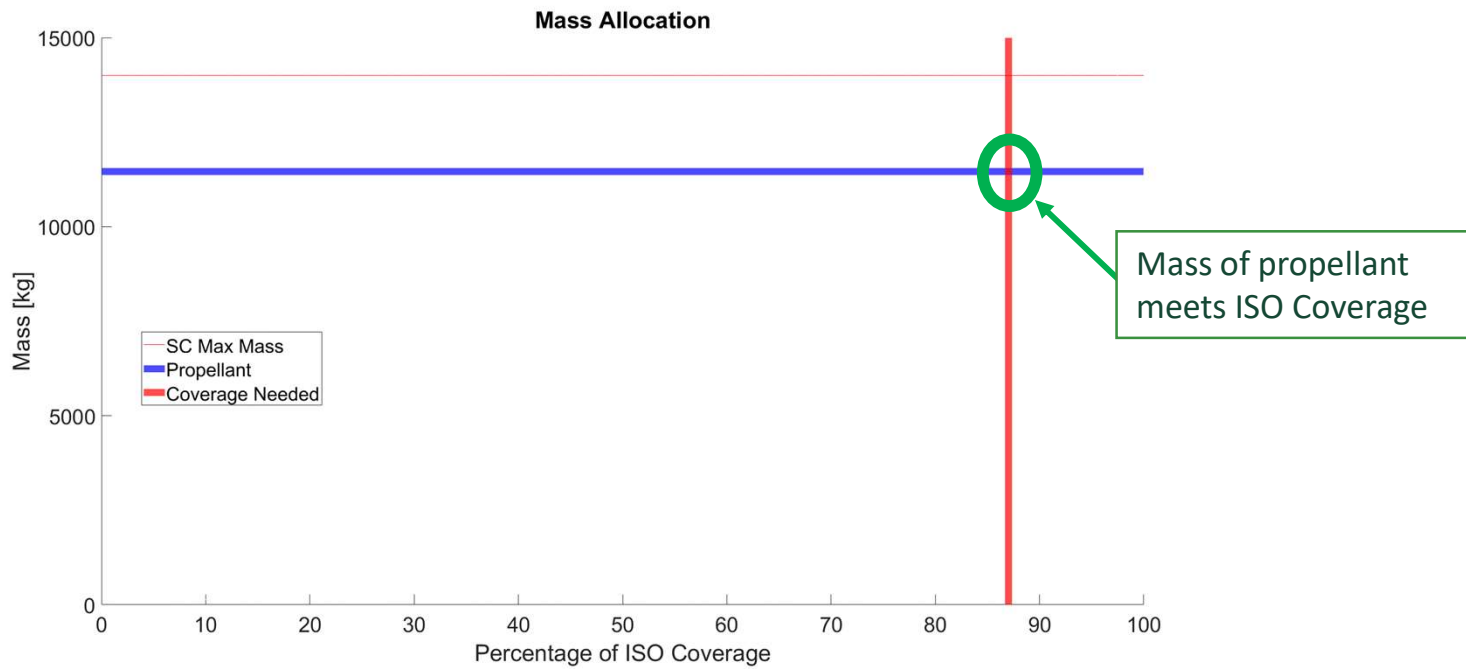

# Mass Sizing

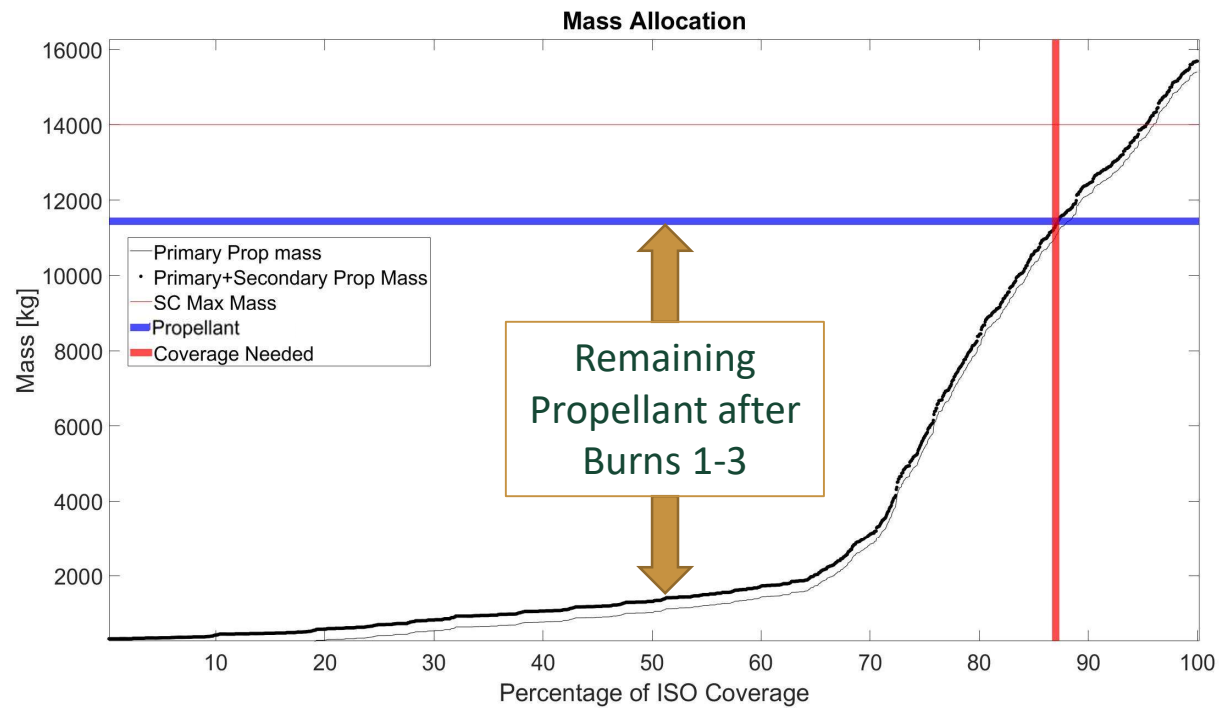

# Flyby Velocity Reduction

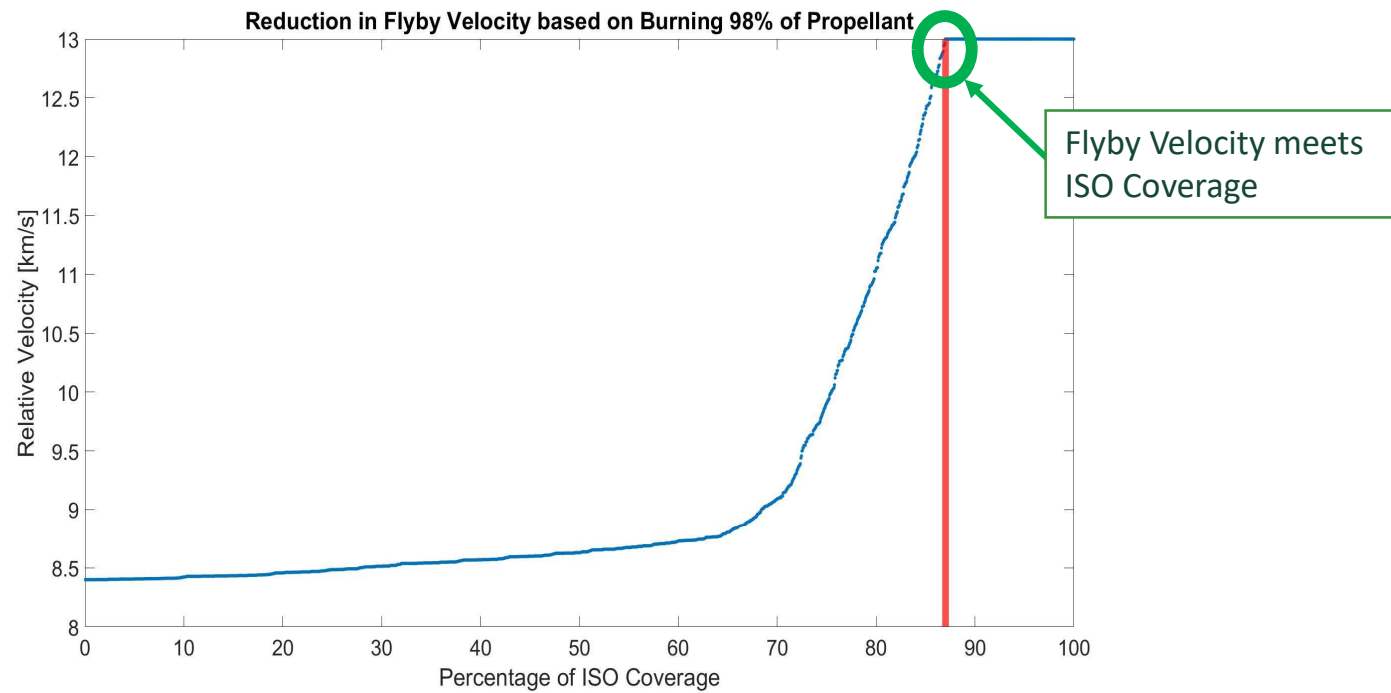

# ISO Flyby Risks -

Given that...	There is a possibility of...	Adversely impacting...	Which can result in...	Likelihood (out of 5)	Severity (out of 5)	Sub team
There are uncertainties about the ISO state	The ISO not being at the distance or relative velocity that was predicted	The propulsion system's dV capability and payload subsystem	The spacecraft navigating to a location from which we can no longer complete the mission	2	3	Orbits

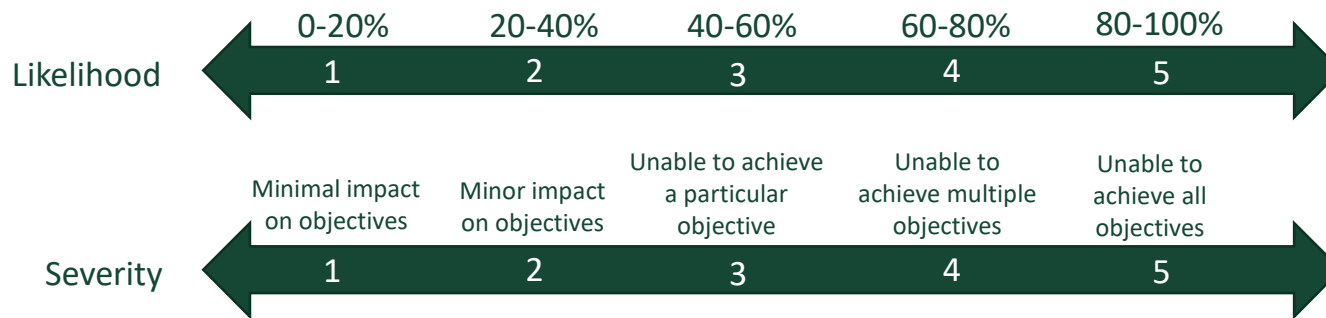

# Phase 4: Navigation to ISO

## *Applicable Level 3 Propulsion Requirements*

ID	Requirement	Driving Phase	Compliance
PROP1	The propulsion system shall provide the flight system with a dV of 4.5 +/- 0.5 km/s for transport to the ISO .	4	Yes
PROP4	The propulsion system shall have a minimum reliability of 98.5%	All	Maybe
PROP5	The propulsion system shall have a mass of 11481 kg +/- 300 kg	All	Yes
PROP6	The propulsion system shall have a volume of 15 m <sup>3</sup> +/- 3 m <sup>3</sup>	All	Yes
PROP7	The propulsion system shall operate in the space environment for 22 years.	All	Yes
PROP8	The propulsion system shall operate at a heliocentric range of 0.5-7 AU	All	Yes

# Propulsion System

- Propulsion system is composed of:
  - Primary propulsion**, which will be used for large-dV maneuvers such as navigating to the ISO
  - Secondary propulsion**, which is used for repositioning burns, stationkeeping, and ADCS CMG singularity-avoidance
- Propulsion system designed to be one-fault tolerant to ensure we're always able to get to the ISO
  - Most valves have single-redundant backups
  - All thrusters a single-redundant backup
  - Pressure/temperature measurements are taken in triplicate, using the median value

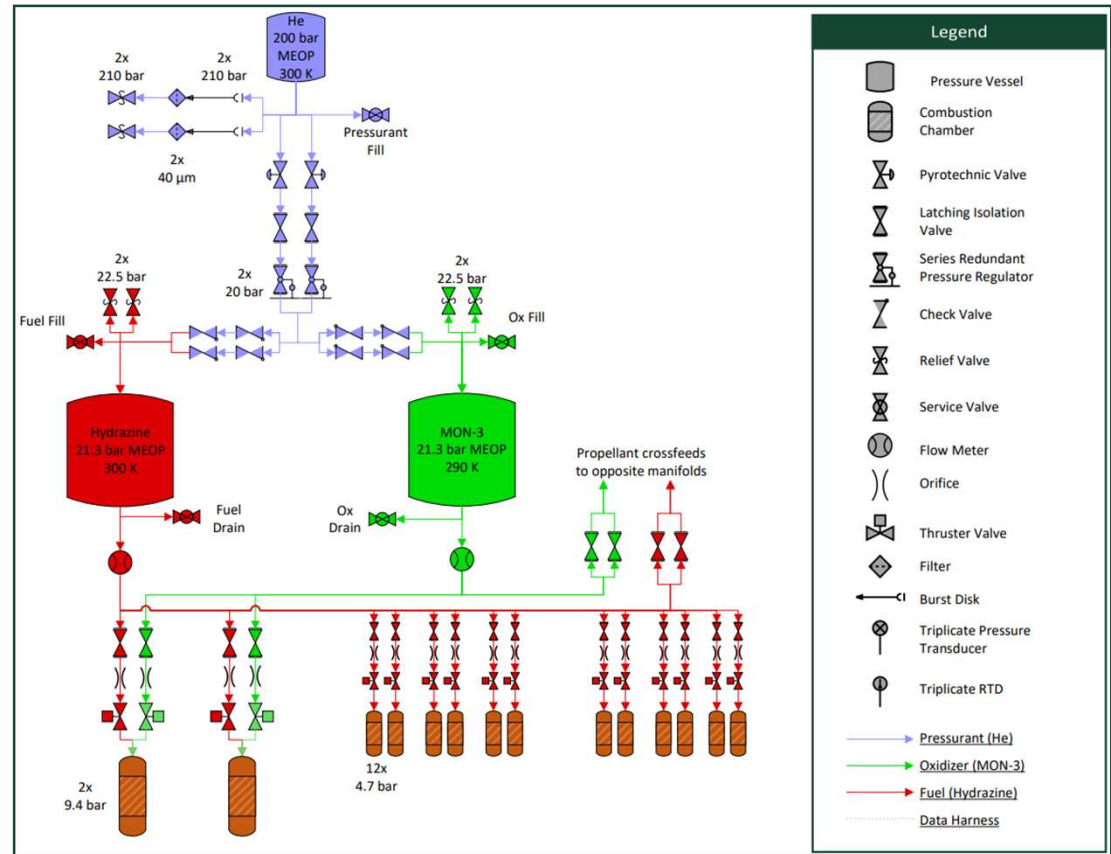

Backup



# Propulsion System Components

- Tank sizing was calculated using propellant mass outputs from the Mass Model.
  - The tanks are [designed](#) as homogenous 6Al-4V titanium
  - Tanks will use a surface-tension style propellant management device ([PMD](#)) to ensure proper propellant flowrate in zero-G conditions
  - Extra [ullage](#) space in the fuel tank allows blowdown functionality for small burns prior to pyro valve actuation.
  - A propellant utilization ([PU](#)) algorithm will be used to ensure maximum  $dV$  for a given propellant split.

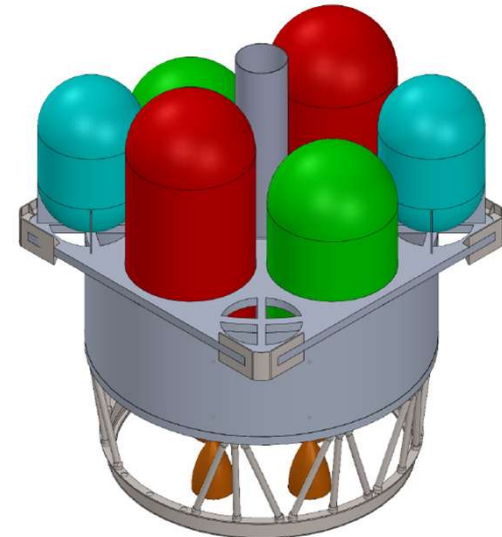

Thruster	Quantity	Propellants	Thrust [N]	Isp [s]	Mixture Ratio
<a href="#">R-4D-15</a>	4	Hydrazine/MON-3	445	329	0.70-1.33 1.0 Nominal
<a href="#">MR-111G</a>	24	Monopropellant Hydrazine	4	229-219	N/A

Backup

# Phase 4: Navigation to ISO

## *Applicable Level 3 Structure Requirements*

ID	Requirement	Driving Phase	Compliance (Y/N/M)
STR6	The structure shall sense the thruster's angular position within <b>0.1 +/- 0.01 degrees</b> .	Phase 4	Yes
STR9	The structure shall articulate the thrusters <b>+/- 8 degrees</b> from the zero position.	Phase 4	Yes

# Mechanisms - Structures

Mechanism	Source	Total Mass	Continuous Draw	Actuation Draw	Actuation Type	Range	Resolution	Operating Temperatures	Details
Thruster Ring Actuator (x8)	<a href="#">MOOG 310</a>	16 kg	<28 V DC	28 V DC	Motion translation (rotational to linear)	17 cm stroke	0.025 mm	-50°C to 80°C	[2]

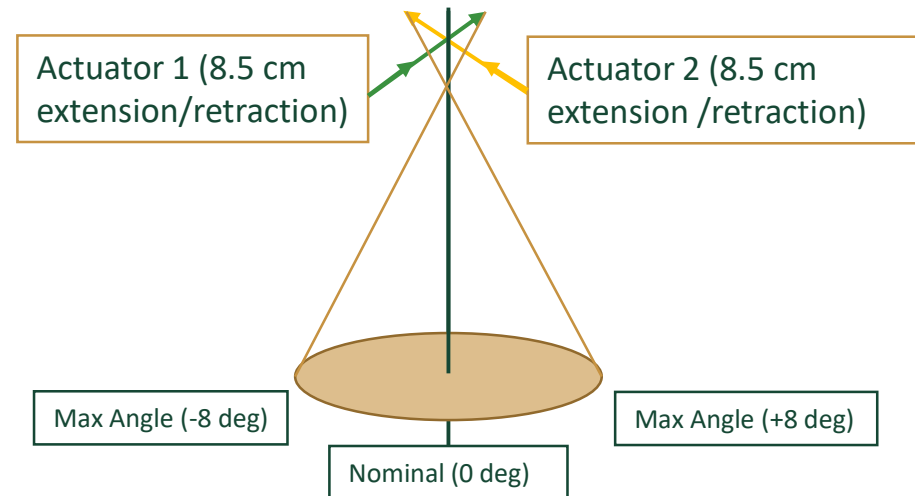

# Phase 4: Navigation to ISO

## *Applicable Level 3 Power Requirements*

ID	Requirement	Driving Phase	Compliance
POW2	The power system's solar panels shall generate a minimum of <b>690 + TBD</b> Watts at end of life.	Phase 6	Yes
POW3	The power system shall allocate power for each subsystem as specified by <b>Table 2.0</b> .	N/A	Yes
POW4	The power system shall provide <b>28 +/- TBD</b> Volts to all components.	N/A	Yes
POW5	The power system shall provide <b>305 +/- TBD</b> Watts during system fault mode.	N/A	Yes

# Power Block Diagram

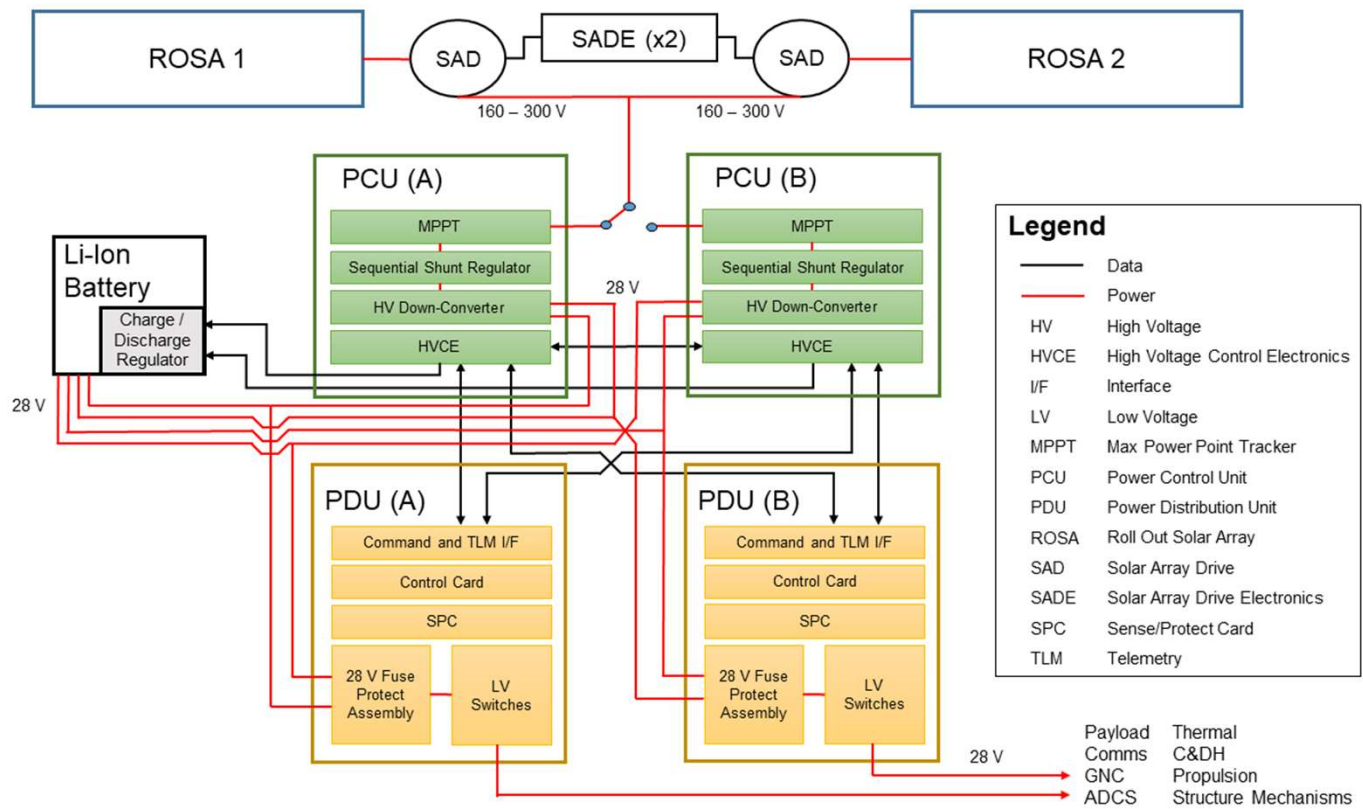

A light green topographic map background with contour lines, partially visible behind the text.

# Thank you!

# End of Day 1



**CAL POLY**

Speaker: David S.

# Preliminary Design Review – Day 2

C.O.S.M.I.C – Friday, June 4<sup>th</sup>, 2021



**CAL POLY**

---

# Introduction

---

Speaker:



---

# C.O.S.M.I.C. (Celestial Object Sensing and Measuring Identification Campaign)



**Our Team** is a dedicated engineering group of 72 Cal Poly Spacecraft Design students working cooperatively in a virtual environment.

**Our Mission** is to provide space systems for interstellar exploration to further our understanding of the origins of the solar system through the study of interstellar objects and near-parabolic comets.

# Table of Contents

## Day 2 (Fri, 6/4)

1. Introduction (92)
  1. Overview of Day 1 (95)
2. Mission Phases Cont. (96 – 148)
  1. Phase 5: Interstellar Object Flyby (96)
  2. Phase 6: Data Downlink (135)
  3. Phase 7: Decommission (145)
3. Project Life Cycle, System Integration and Test (149)
4. Mission Budget (161)
5. Summary (164)
6. Support Slides (170-327)

## Day 1 Recap (Wed, 6/2)

1. Introduction (2)
  1. Entrance and Success Criteria (5)
  2. Solicitation Breakdown (6)
  3. Design Challenges (9)
2. System Design (15)
3. Mission Phases (22 – 89)
  1. Phase 1 : Launch (22)
  2. Phase 2 : Orbital Insertion (37)
  3. Phase 3 : Prepositioned (44)
  4. Phase 4 : Navigation to ISO (67)
4. Closing Remarks (90)



# Day 1 Summary

- Introduced the Solicitation
  - Composition
  - Morphology
  - Angular Momentum
  - Advanced Object Definition
  - Remote Observation
  - Exoplanet
- Decomposition of System Design
  - Phase 1: Launch to Detumble
  - Phase 2: Orbital Insertion into Preposition
  - Phase 3: Prepositioned
  - Phase 4: Navigation

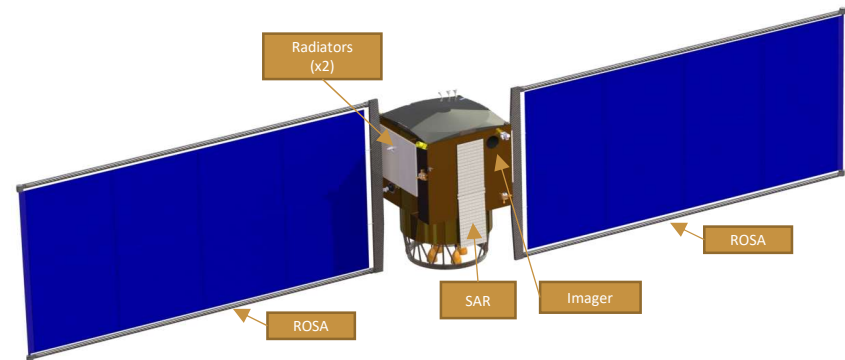
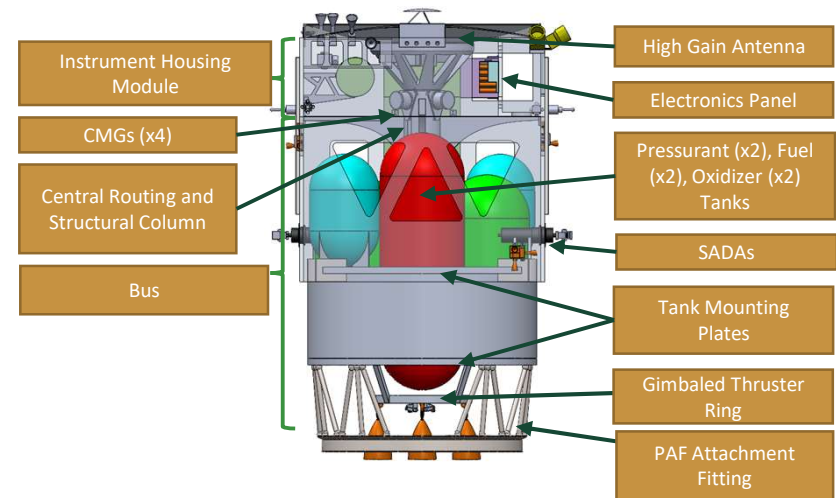

---

# Phase 5

---

Speaker: Sean T.



# Encounter Strategy: Phase 5

## Mission Concept of Operations

### Phase 5

The Encounter S/C will begin Autonomous Optical Navigation at 55,000 km away from the ISO on the inbound trajectory. At **4000 km away from the ISO, the IR imager will begin taking images of the ISO surface.** Once the S/C is **2000 km away from the ISO, visible imaging will begin.** At **800 km away, the SAR system will begin taking snapshots.** The **closest approach will be 400 km away.** The **Encounter S/C will stop collecting primary science data at 4000 km away on the outbound trajectory.**

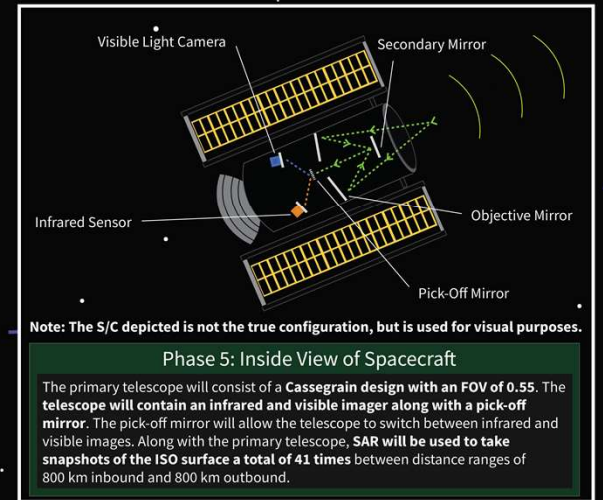

Maximum Relative Velocity = 13 km/s

### Legend

- S/C Trajectory
- ISO Trajectory
- ))) Radar Signals Used for SAR (Will not be visible)
- Initial Light from ISO
- Visible Light from ISO
- Infrared Light from ISO

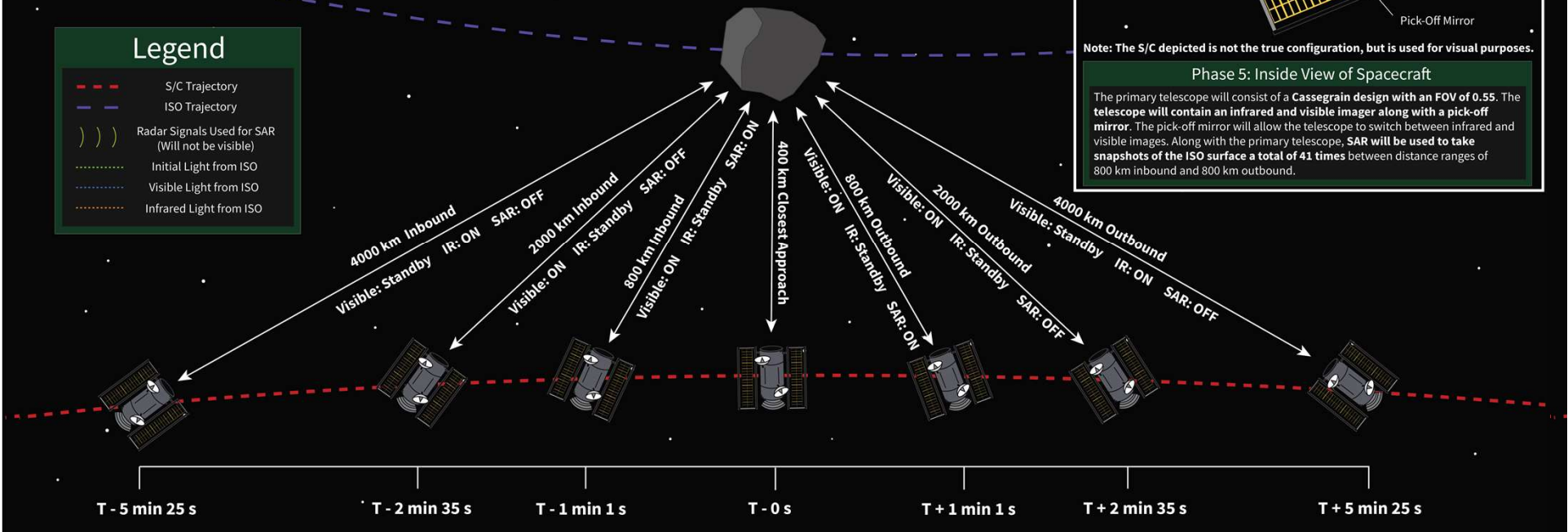

# Phase 5: Encounter

## *Applicable Level 2 Flight System Requirements*

ID	Requirement	Compliance (Y/N/M)
F9	The flight system shall operate autonomously within 24 hours of closest approach.	Y
F11	The flight system shall acquire visible imagery of the object at a resolution of 5 mpp.	Y
F12	The flight system shall acquire infrared imagery of the object at a resolution of 10 mpp.	Y
F13	The flight system shall acquire radar data of the object with a maximum doppler shift precision of 0.0515 Hz at closest approach to the ISO.	Y
F14	The flight system shall image the object's orthogonal axes.	Y
F15	The flight system shall perform trajectory corrections to achieve a closest approach distance of 400 km +/- TBD.	Y
F16	The flight system shall perform trajectory corrections to achieve a maximum relative velocity to the ISO of 13 km/s at closest approach.	Y
F32	The flight system shall support a total data volume of up to 21 GB.	Y
F34	The flight system shall acquire radar data of the object with a maximum slant range uncertainty of 1.5 meters at closest approach.	Y
F35	The flight system shall acquire radar data every 3 degrees of angular position between the ISO and the spacecraft.	Y



---

# Encounter Models

---

## Effect of ISO Rotation Rate on Primary Objectives

ISO Rotational Period	Spin Axis	Rotation Rate	Shape Model Percent Coverage		
	Spin Axis Error	Confidence Within +/-1.0%	+/- 10 m resolution	+/- 20 m resolution	+/- 30 m resolution
8 min	≤0.18°	H	50.3%	67.7%	73.5%
10 min	≤0.23°	H	48.2%	66.5%	73.0%
42 min	≤1°	H	22.7%	42.2%	49.5%
1 hr	1.4°	H	14.9%	36.7%	45.8%
2 hr	2.8°	H	0%	20.7%	34.1%
4 hr	6.2°	H	0%	0%	12.5%
6 hr	12.2°	H	0%	0%	0%
5 days	>50°	H	0%	0%	0%
10 days	>50°	M	0%	0%	0%
20 days	>50°	L	0%	0%	0%



# ISO Flyby Risk

Given that ...	There is a possibility of...	Adversely impacting...	Which can result in...	Likelihood (out of 5)	Severity (out of 5)	Sub team
There are unknowns about the ISO	The angular velocity of the ISO being too slow	The post-processing of the mission data necessary to generate the shape mode and determine the spin axis	The radar data not being able to produce a shape model with the required resolution and the images taken not being able to produce spin axis to the required error	4 *unknown because not enough data on ISOs	3-4 Not meeting some primary objectives to the required error but still getting data	Sci Tech

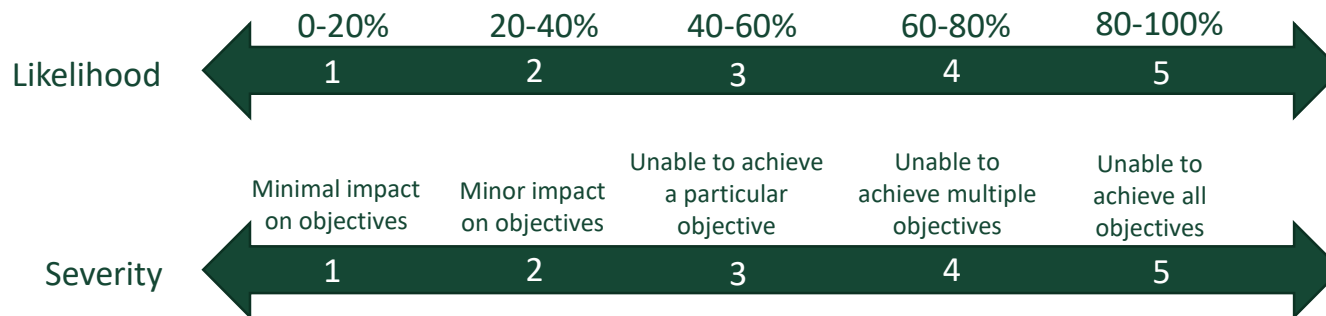

---

# Rotation Rate Method Overview and Assumptions

- Method Overview
  - IR light curves will be used to determine the rotation rate of the ISO
  - Images will be taken for ~20 days during OpNav
  - Data will be downlinked before auto navigation begins
- Assumptions (taken from Rosetta flyby of asteroid Steins)
  - The rotation rate can be determined to within 1% with:
    - An imaging rate of 60 images per period
    - An imaging duration between 3 and 4 rotational periods
  - A comet coma will have negligible effects on the light curves

# Rotation Rate Method Results

Level 1 Reqs

**MP8** The mission shall determine the object's rotation rate within 1%. ✓ Period ≤ 5 days

ISO Rotation Period	Imaging Duration (periods)	Imaging Rate (images/period)
< 0.35 hours	> 4	< 60
0.35 hours to 5 days	3 - 4	≥ 60
5 days to 10 days	2 - 3	≥ 60
10 days to 20 days	1 - 2	≥ 60

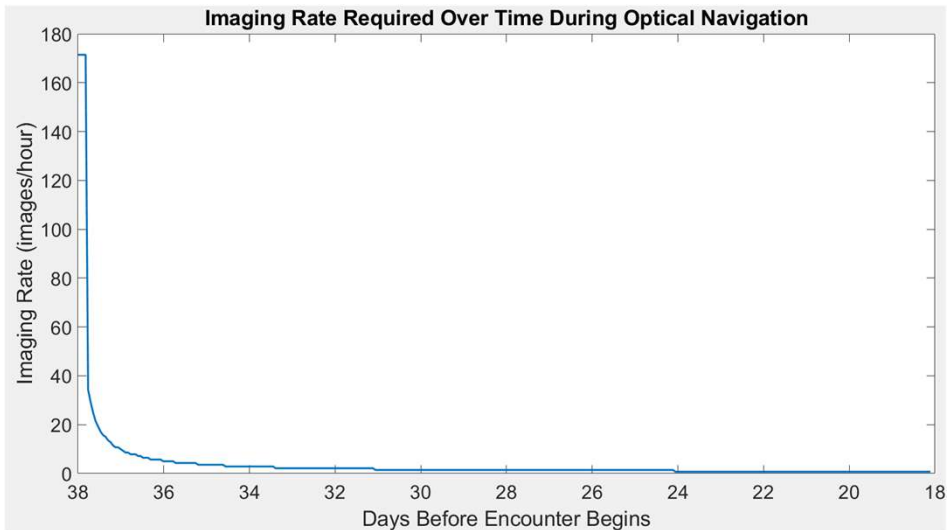

- Requires access to the DSN for 46.2 hours during the 2.2 weeks prior to the encounter.
- Using light curves, the requirement is met for rotation periods between 0.35 hours and 5 days.
- Other radar and image data can be used to determine the rotation rate within 1% for periods less than 0.35 hours.

# Spin Axis Model

MP7

The mission shall determine the object's spin axis within +/- 1.0 degree.

✓ Period  $\leq 0.7$  hr

- Model Assumptions
  - There are identifiable features that can be tracked over multiple images
  - Spin axis orientation problems ignored because of multiple viewing angles during encounter
  - ISO can be seen with IR and visible imaging (may have problems with comet comas)
- Model Overview
  - Spin axis can be determined by tracking points on a set of images
  - Spin axis knowledge error is calculated by varying time intervals of data

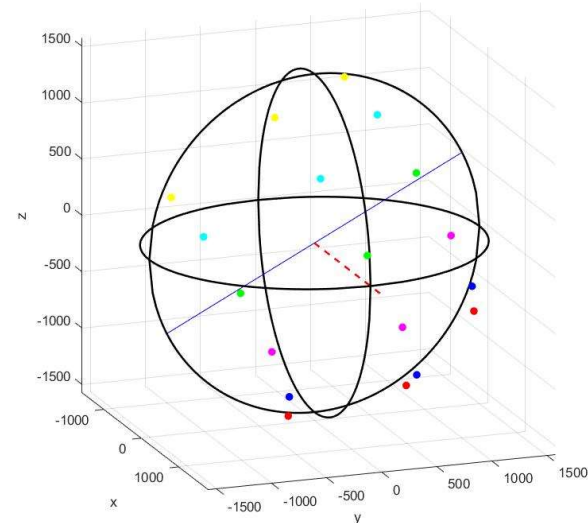

# Spin Axis Model

- Strong correlation between amount of rotation seen and spin axis knowledge error
- Longer imaging intervals required for longer period ISOs

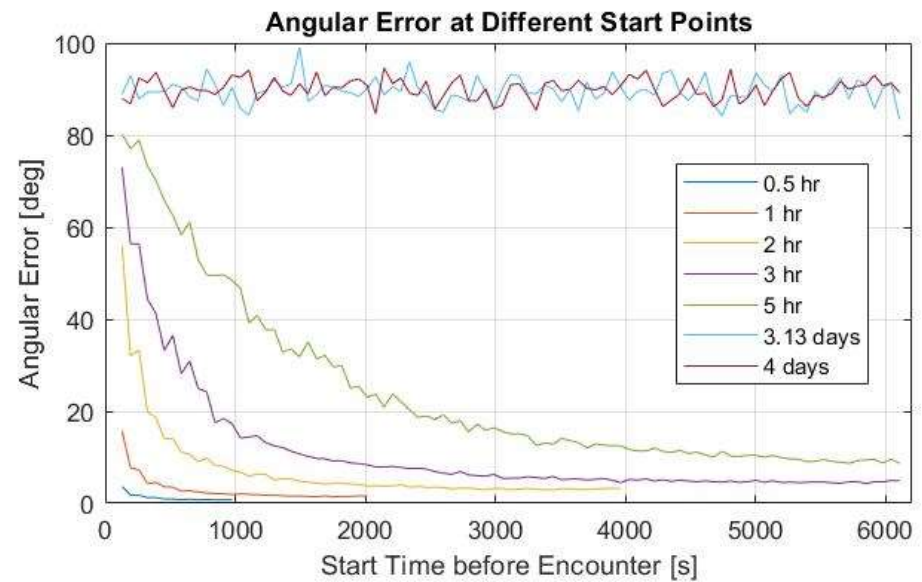
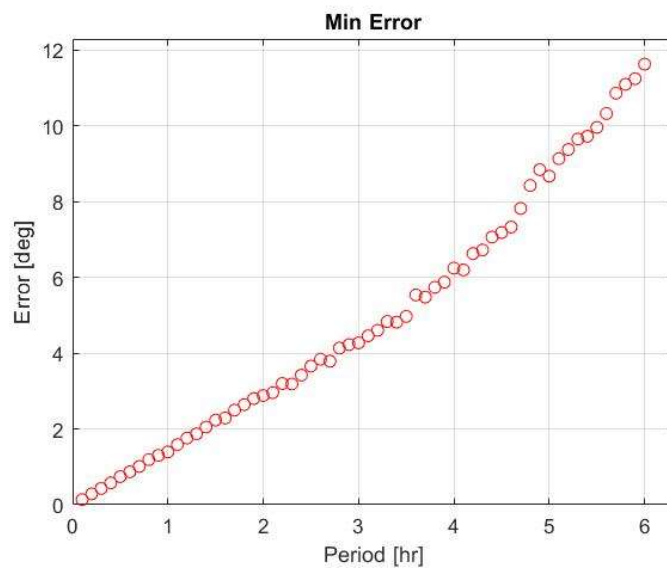

# Image Quality Model (Smear + Jitter)

## Jitter:

- Can obtain required resolution for IR/Visual with Jitter =  $1^{-4}$  rad/s
- Exceeds current estimated Jitter by 190%

## Smear:

- Cross-Track Smear is fully corrected by slew profile.
- Along-Track (Radial) Smear is given by:  $iFOV \times \Delta t_{exp} \times v_{relative}$

Req: F11 ✓

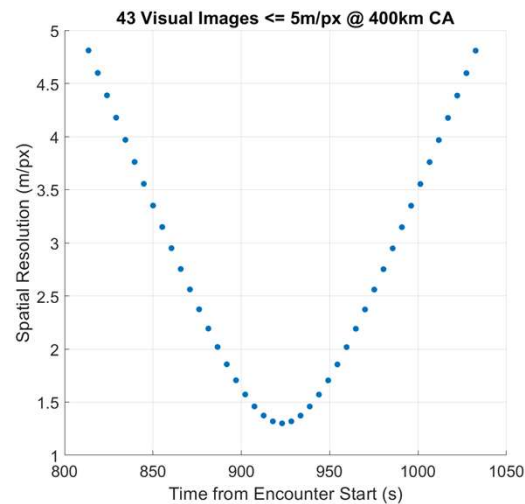

Req: F12 ✓

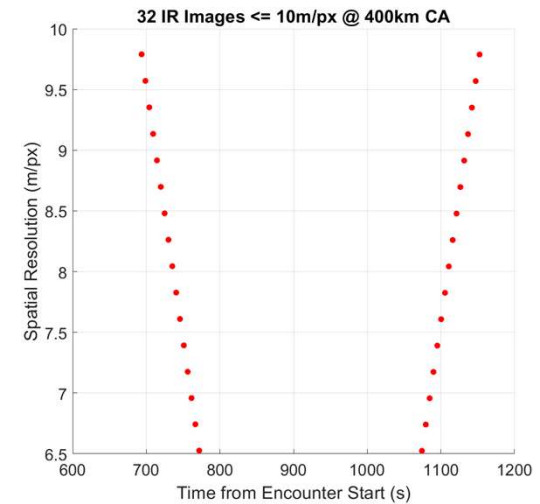

# Visual and IR Surface Coverage

## Assumptions:

- IR Range = [4000, 2000] km
- Visual Range = [2000, 400] km
- Min. Exposure Time = 15ms
- Max. Framerate = 5 FPS
- Best Image stored per 5s interval



Req: MP4 ✓

Req: MP3 ✓

Stats from ISO Cases A, B, C	Visual (Lit) Coverage %	IR (Unlit) Coverage %
Mean	48.75	97.83
1 $\sigma$	1.00	0.73

# Mean Dimension Model

**MP6**

The mission shall determine the object's mean dimension within +/- 10 meters.

✓ Period &gt;12 s

- Model Assumptions
  - Spherical ISO
  - Non viewing side of ISO is not concave
- Conclusion
  - Opposite cases within +/- 10 m requirement for 160° viewing angle
  - Mean dimension requirement will be met from data already collected for other primary objectives

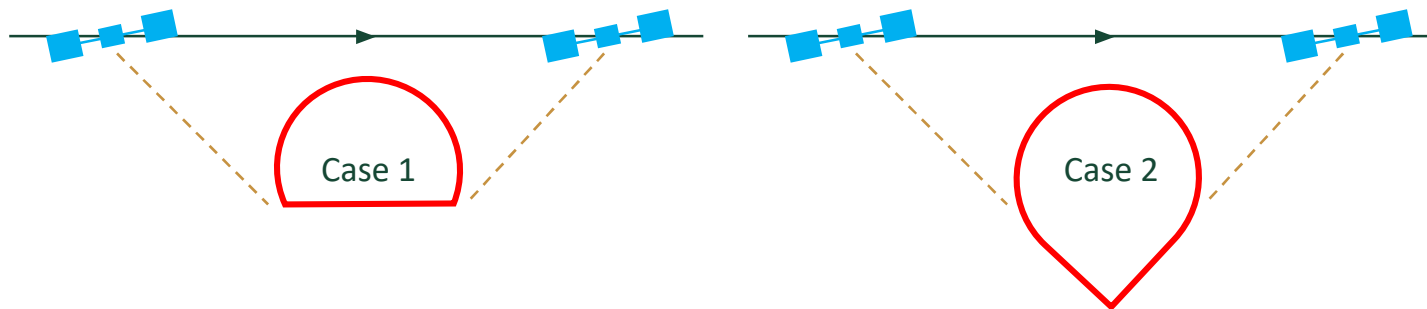



# SAR Shape Model Assumptions

- Spherical ISO shape with radius of 750 meters
- The uncertainties in the following values have a negligible effect on the final shape model:
  - Radar orientation in inertial space during encounter
  - Time stamps on all radar and orientation data
  - Backscatter power measurement (24-bit samples)
  - Angular velocity of the ISO
- Backscatter from the entire surface visible to the radar is collected by the receiver
- Assume the sub-radar latitude ( $\delta$ ) is 30 degrees

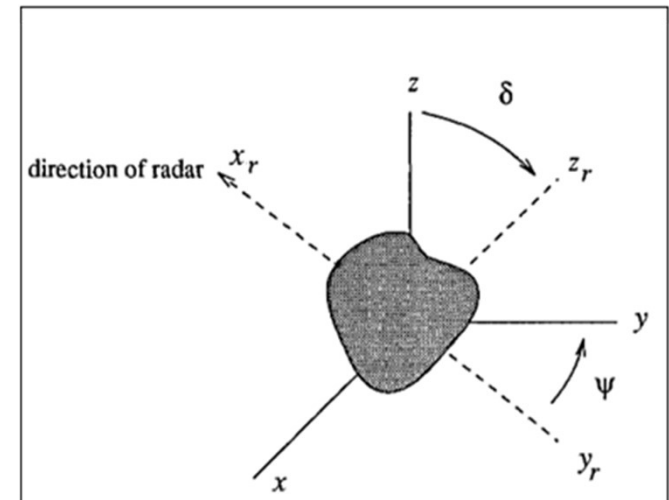

Scott Hudson (1994) Three-dimensional reconstruction of asteroids from radar observations, Remote Sensing Reviews, 8:1-3, 195-203, DOI: [10.1080/02757259309532195](https://doi.org/10.1080/02757259309532195)

# SAR Shape Model Results

Level 1 Reqs

MP5

The mission shall model 50% [TBC] of the object's shape within +/- 10 meters using active measurement.

✓ Period ≤ 8 minutes

- Encounter Parameters

- Relative Velocity: 13 km/s
- Slant Range to ISO when Data Collection Begins and Ends: 800 km
- Closest Approach Distance to ISO: 400 km
- SAR coherent processing interval: 1.63 seconds
- Pulse every 3 degrees in angular position to ISO

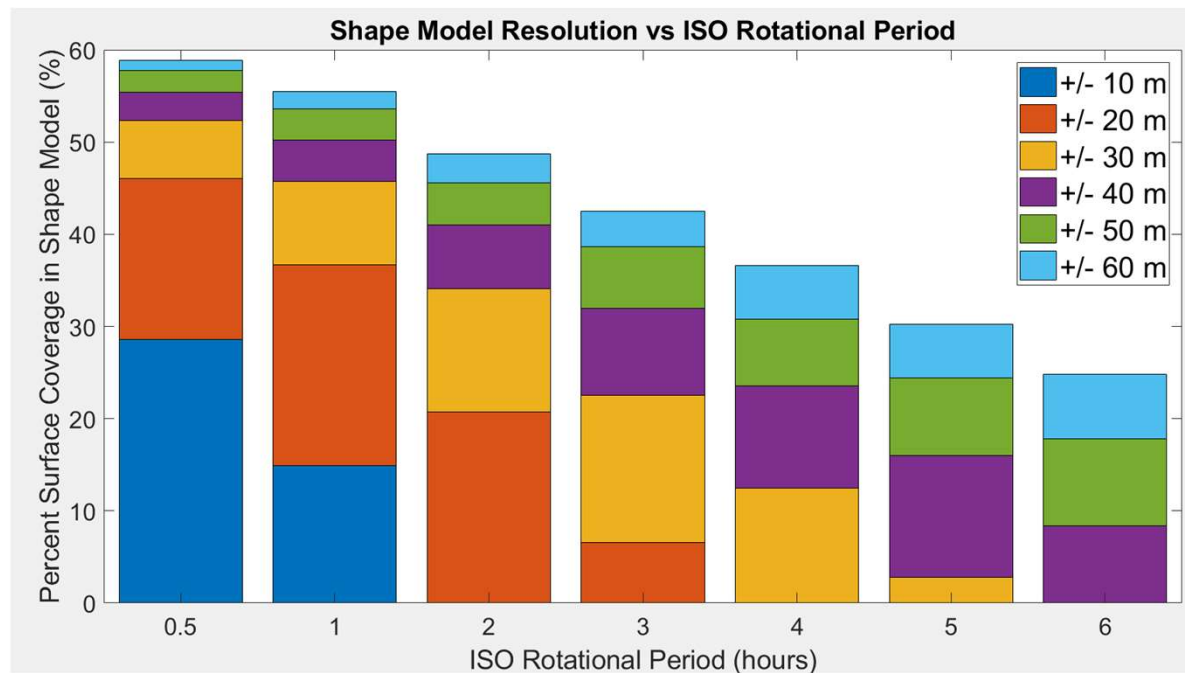

# Shape Model – Additional Data

- The visual images taken during the flyby can also be used to generate a shape model.
- This data can supplement the radar data to develop a better shape model.
- All visual images are expected to capture around 48.75% of the total ISO surface area.

Resolution (meters per pixel)	Number of Images
≤ 5	43
5 - 10	32 (IR)
10 - 15	46
15 - 20	46
20 - 25	46
25 - 30	44

# Torque vs. Encounter Variables

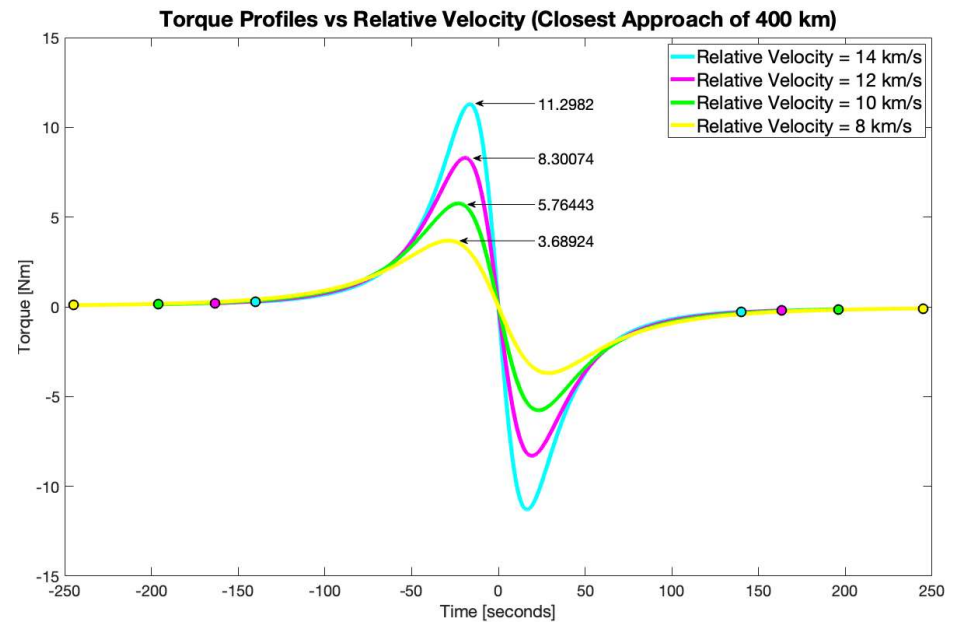
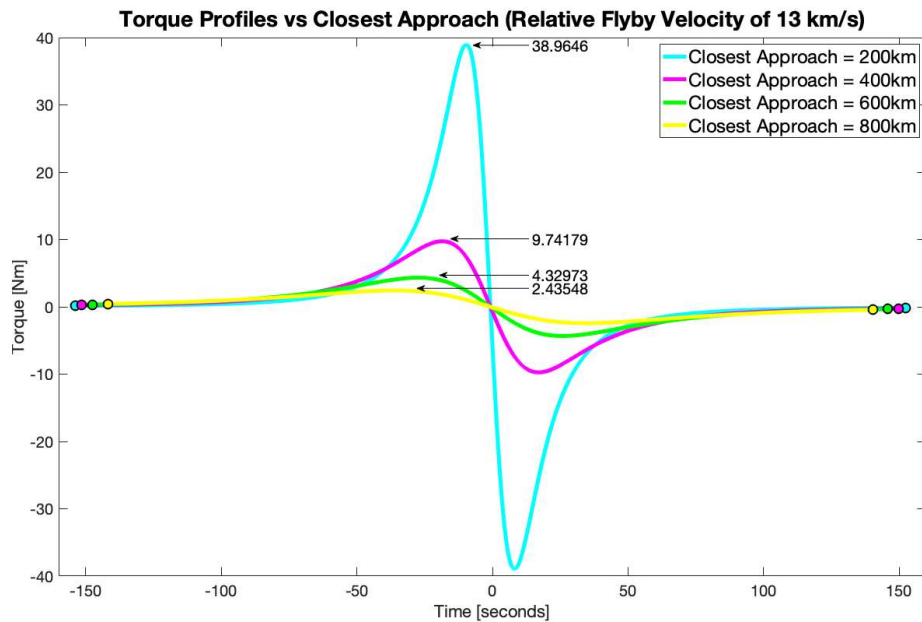

# Encounter Summary

Parameter	Range	Driving Considerations
Maximum Encounter S/C Relative Velocity to ISO	13 km/s	Decision to use Chemical propulsion system
Distance from ISO AON Begins	55000 km	Distance that ISO resolves to > 1 pixel using APIC
Primary Telescope Begins Taking IR Images	4000 km away from ISO on inbound trajectory	10 mpp spatial resolution is achieved at 4000 km
Primary Telescope Begins Taking Visible Images	2000 km away from ISO on inbound trajectory	5 mpp spatial resolution is achieved at 2000 km
SAR Begins	800 km away from ISO on inbound trajectory	The SNR for the SAR is too low past 800 km
Closest Approach Distance	400 km	The SNR for the SAR is sufficient at 400 km
SAR Ends	800 km away from ISO on outbound trajectory	The SNR for the SAR is too low past 800 km
Primary Telescope Stops Taking Visible Images	2000 km away from ISO on outbound trajectory	No longer satisfy solicitation req at this distance
Primary Telescope Stops Taking IR Images	4000 km away from ISO on outbound trajectory	No longer satisfy solicitation req at this distance
Encounter Duration	11 min and 14 sec +/- 3 min and 30 sec	Function of closest/furthest approach distance and relative velocity
Maximum Distance from Sun at Closest Approach	5 AU	Beyond this we won't have enough sunlight for solar power
Number of SAR bursts	41	Provides data redundancy and prevents doppler smearing
Maximum Slew Acceleration Rate	$3.93 \times 10^{-2} \text{ rad/s}^2$	Maintain pointing for ISO within FOV
Total Amount of Data Taken	469.57 MB	Total encounter data collected

---

# Encounter System Design

---

**Speaker:** Helen

# Phase 5: Encounter

## *Applicable Level 3 GNC Requirements*

ID	Requirement	Driving Phase	Compliance (Y/N/M)
GNC 6	The GNC system shall propagate the spacecraft relative position of the ISO to +/- 100 m in the imager cross track axis from T-3 minutes to T+3 minutes.	Phase 5	Maybe
GNC 7	The GNC system shall propagate the spacecraft relative position of the ISO to +/- 1.2 km in the imager down track axis from T-3 minutes to T+3 minutes.	Phase 5	Maybe
GNC 8	The GNC system shall propagate the spacecraft relative velocity of the ISO to +/- 50 cm/s in the imager down track axis from T-3 minutes to T+3 minutes.	Phase 5	Maybe
GNC 9	The GNC system shall propagate the ISO ephemeris from 24 hours prior to the beginning of autonomous operations to 24 hours after closest approach.	Phase 5	Yes

# Auto-OpNav

Method	Time	Down-Track Error	Cross-Track Error
OpNav	T - 24 hrs	9.0 km	9.0 km
Auto OpNav	T - 0 s	1.2 km	0.1 km

- Utilize APIC system to image ISO and star field simultaneously
- APIC resolution becomes **<1 km/pixel** at 55,000 km from the ISO
- ISO ephemeris will be updated every 15 seconds
- No trajectory correction maneuvers after autonomous cutoff

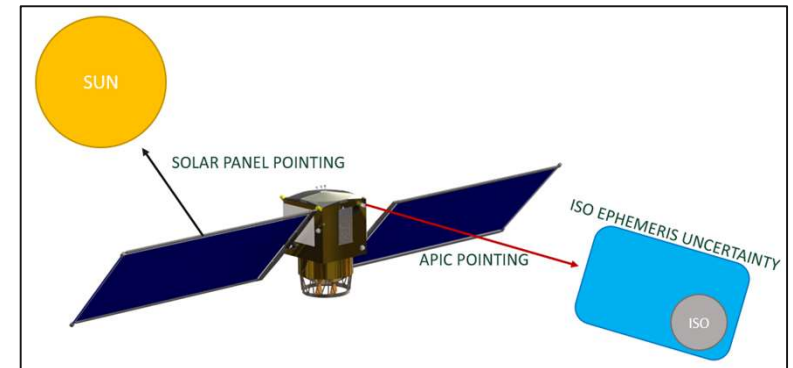

## Primary Pointing

- APIC – Pointed at expected ISO position
- Solar Array – Pointed to Sun

## Mechanisms in use

- APIC
- Solar Drive Mechanism

Mechanism	Source	Mass	Continuous Draw	Actuation Draw	Actuation Type	Range	Resolution	Operating Temperatures	Details
APIC Gimbal	<a href="#">JPL</a>	<5 kg	<12 W	<12 W	Elevation Actuator	+/-90 deg	19 microrad	Actively controlled	[6]



# Phase 5: Encounter

## *Applicable Level 4 C&DH Requirements*

ID	Requirement	Driving Phase	Compliance (Y/N/M)
CDH-C11	The processor card shall have at least 5 MB of RAM.	Phase 5	Y
CDH-C12	The processor card shall handle at least 85.21 kHz bandwidth.	Phase 5	Y
CDH-C13	The C&DH subsystem shall have a redundant copy of itself.	Phase 5	Y
CDH-C14	Each C&DH subsystem shall have a redundant mass memory card.	Phase 5	Y

[Backup](#)

# OBC Design – C&DH

ID	Requirement	Driving Phase	Compliance (Y/N/M)
CDH-C11	The processor card shall have at least 5 MB of RAM.	Phase 5	Y
CDH-C12	The processor card shall handle at least 85.21 kHz bandwidth.	Phase 5	Y

- Current minimum required RAM is 5 MB
  - Informed via APIC autoNav requirements
- Each OBC will have **8 MB RAM**
- Processing speed 85.21 (kHz, direct calc from required)
- OBC will have **100 kHz** (inc. 1.2 F.S)
- Dimensions: 0.4 x 0.3 x 0.25 m (**0.03 m<sup>3</sup> vol.**)
- Mass: **30 kg**
- Power varies by phase, max **95 W**
- Will have an additional C&DH system, one processor card per system

Operation	Processing Speed (kHz)
Secondary Science	69.61
Encounter	85.21

Backup

# Data Harness – C&DH

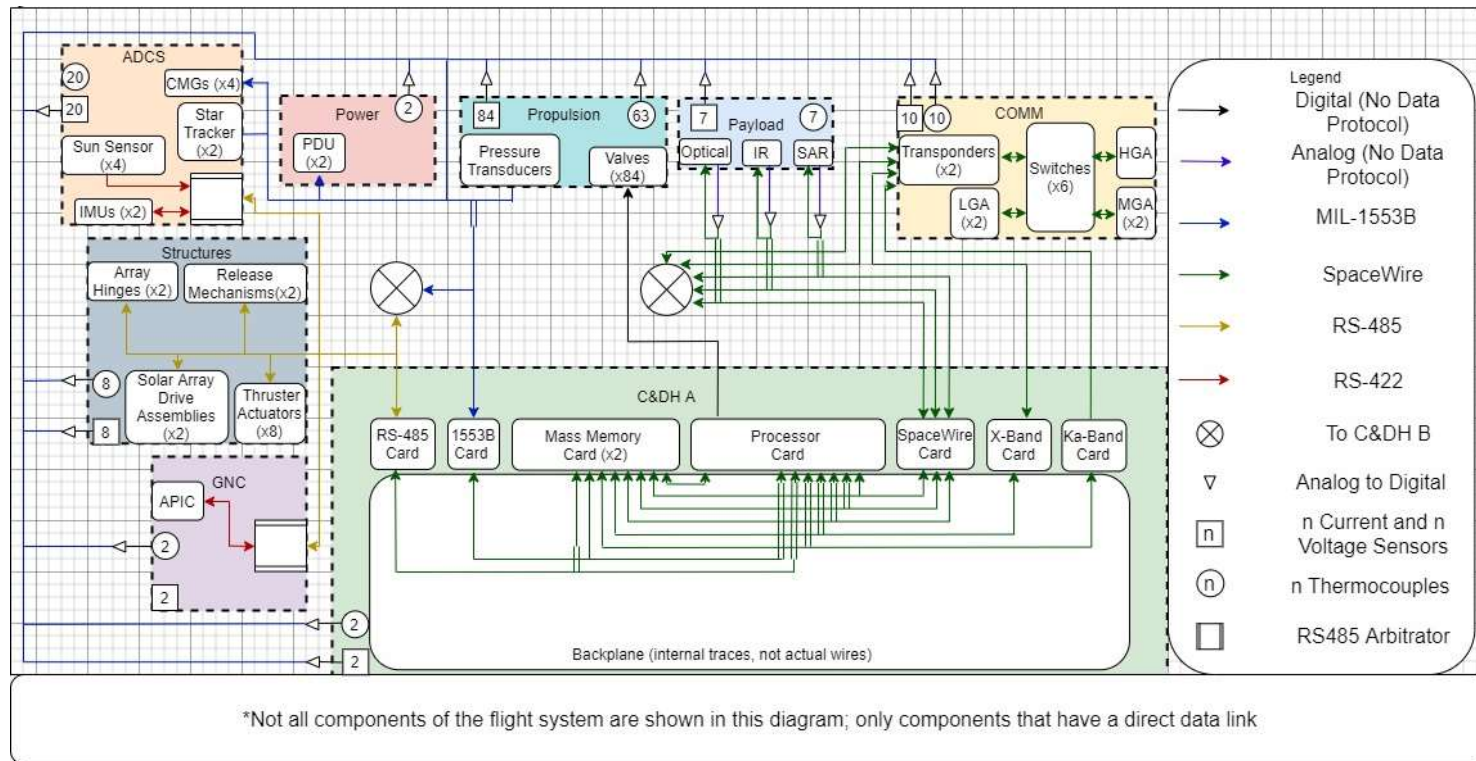

Backup

# Design Specifications - SAR

ID	Requirement	Driving Phase	Compliance (Y/N/M)
PAY-C15	The SAR shall have a gain of 56 dB.	Phase 5	Yes
PAY-C16	The SAR shall acquire radar data of the object with a doppler uncertainty of less than or equal to 0.32 Hz at closest approach.	Phase 5	Yes

SAR Parameter	Value
Bandwidth	0.1 GHz
Central Frequency	26.5 GHz
Power Average	16 W
Power Peak	246 kW
Antenna Size	4m x 1m
PRF	6500 Hz

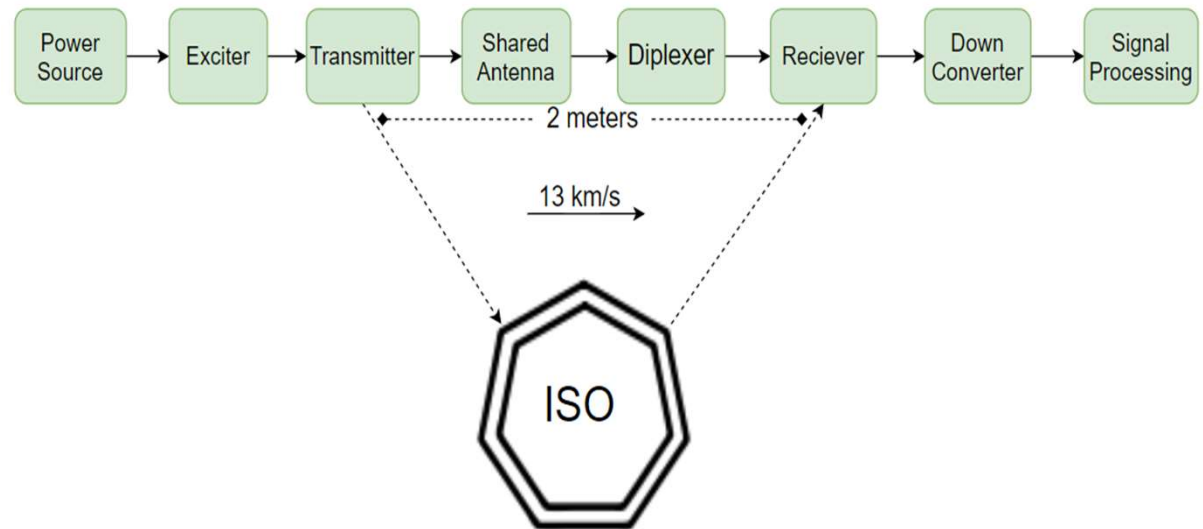

[To SAR Model Verification:](#)

# SAR Mechanisms - Structures

Mechanism	Source	Mass	Continuous Draw	Actuation Draw	Actuation Type	Range	Resolution	Operating Temperatures	Details
Non-Explosive Actuator for SAR	<a href="#">NEA Model 9100</a>	0.7 kg	250 mA	4 A	Hold Down and Release	N/A	N/A	-135C to +135C	[4]
Deployment Hinge for SAR	<a href="#">Deployment System for Large Appendages</a>	1.5 kg	N/A	N/A	Spring driven	90-180 deg.	+/- 0.006 deg.	-30C to +50 C (Survivable temperatures +/-150 C)	[5]

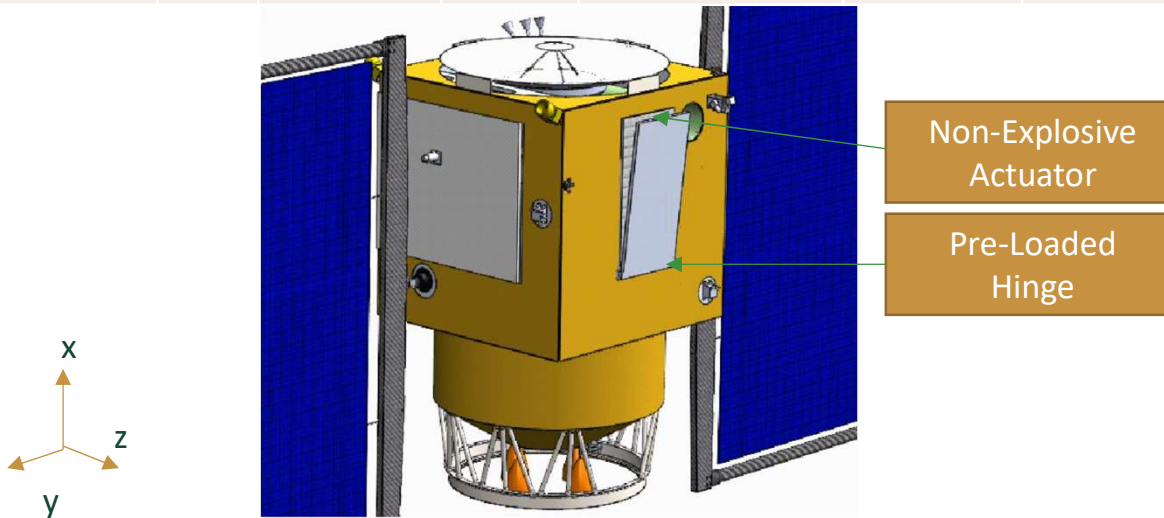

# Bus Connections – Payload (SAR)

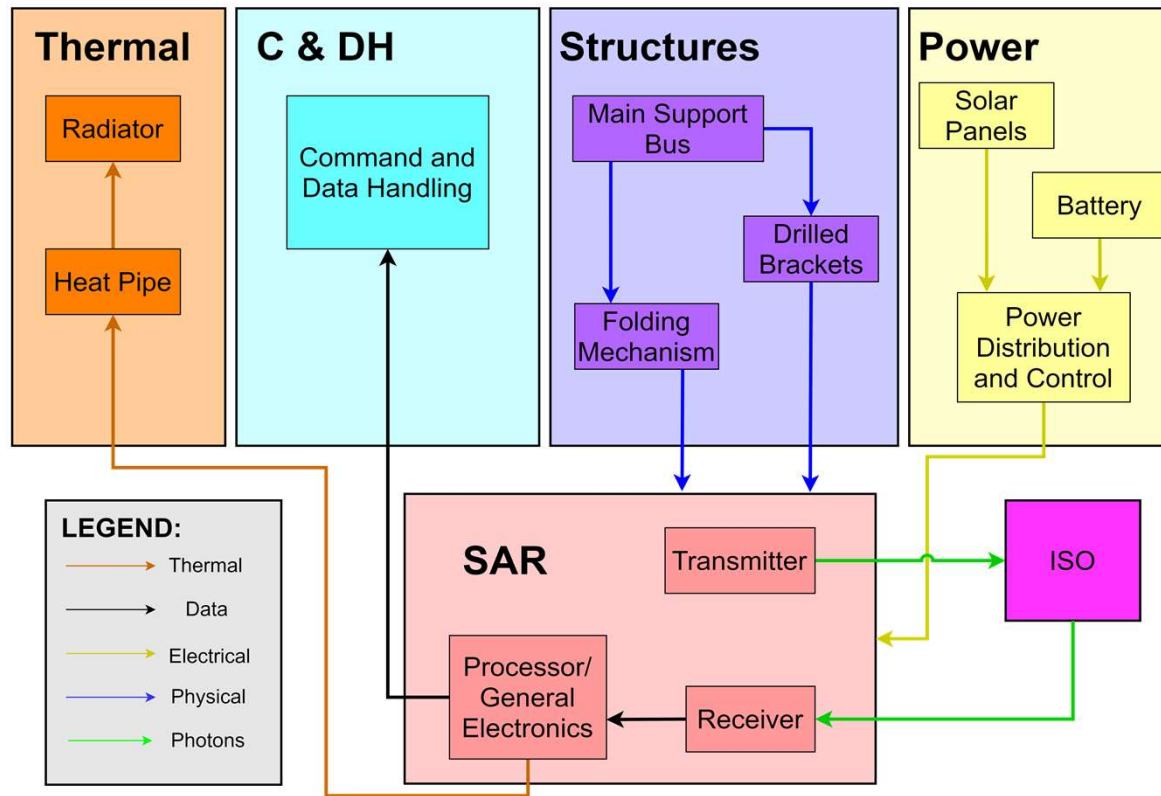

# Advanced Object Definition - SAR

- Active measurement of shape and range
  - Achieved since we are using the SAR for our morphology model
- Active measurement of surface dielectric properties
  - SAR can determine dielectric constant by computing the co-polarized radar cross section for VV and HH polarizations.

$$\frac{\sigma_{HH}}{\sigma_{VV}} = \frac{\cos(\theta_i) - \sqrt{\epsilon_r - \sin^2(\theta_i)} \left( \cos(\theta_i) + \sqrt{\epsilon_r - \sin^2(\theta_i)} \right)^{-1}}{(\epsilon_r - 1) [\sin^2(\theta_i) - \epsilon_r - \epsilon_r \sin^2(\theta_i)] \left[ \epsilon_r \cos(\theta_i) + \sqrt{\epsilon_r - \sin^2(\theta_i)} \right]^{-2}}$$

Equation: Marghany, Maged. "Synthetic Aperture Radar Imaging Mechanisms for Oil Spills" 2020

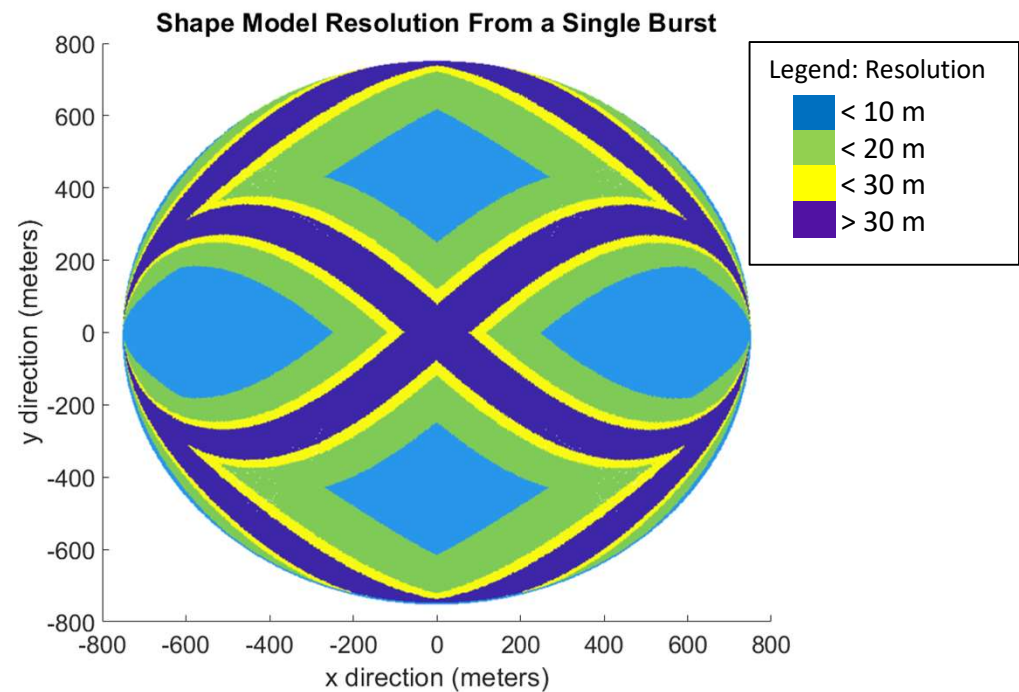

# Phase 5: Encounter - Imager

## *Applicable Level 3 Payload Requirements*

ID	Requirement	Driving Phase	Compliance (Y/N/M)
PAY4	The payload shall be capable of taking a visible image once every 200 milliseconds.	5	Y
PAY5	The payload shall be capable of taking an infrared image every 200 milliseconds.	5	Y
PAY6	The payload shall be capable of taking a visible image with an exposure time of 13 milliseconds.	5	Y
PAY7	The payload shall be capable of taking an infrared image with an exposure time of 13 milliseconds.	5	Y
PAY8	The payload shall have an FOV of 0.55 degrees.	5	Y
PAY9	The payload shall articulate between the visible and infrared sensors.	5	Y
PAY12	The visible CCD board shall collect the visible imagery signal.	5	Y
PAY13	The infrared CCD board shall collect the infrared imagery signal.	5	Y



# Design Specifications - Imager

- Imaging system designed to meet 10 meter per pixel IR resolution and 5 meter per pixel visual resolution
- Cassegrain telescope
- CCD boards used for visual and IR sensors
- Pick off mirror to direct light into correct sensor
- 15 ms exposure time

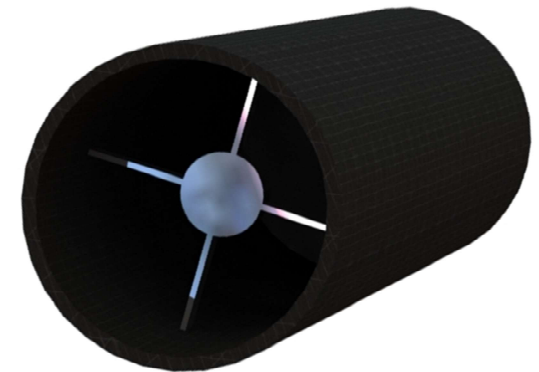
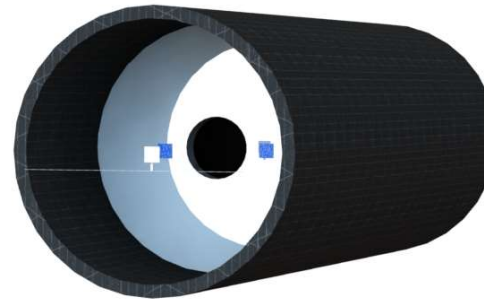

# Design Specifications - Imager

Imager Parameter	Value
Total Length	2 m
Primary Aperture	0.500 m
Secondary Aperture	0.125 m
System Focal Length	6 m
FOV (visual and IR)	0.55 deg

Sensor Parameter	Value
Pixel Count	2715 x 2715
Pixel Size	0.015 mm x 0.015 mm
Full Well Depth	300000 e
Pixel Data Rate	3-6 MHz
Readout Rate	20 ms
Image Size	1.87 MB

# Bus Connections – Payload (Imager)

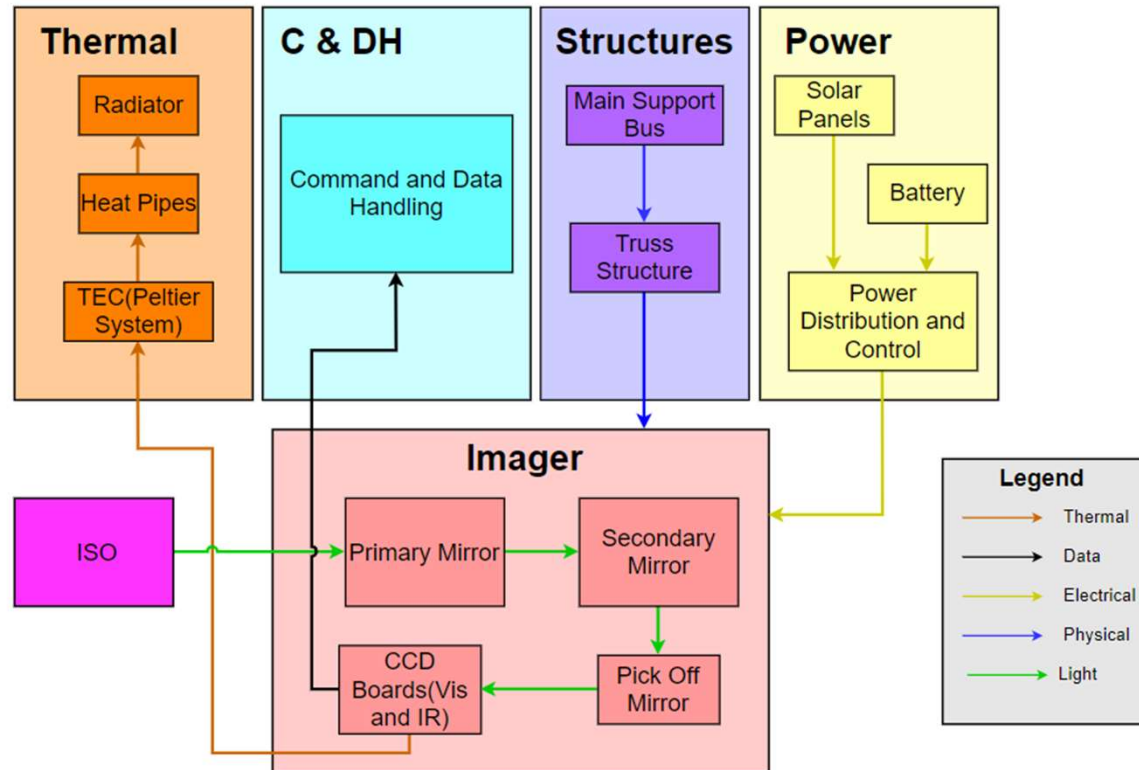

# ISO Related Risks

Given that...	There is a possibility of...	Adversely impacting...	Which can result in...	Likelihood (out of 5)	Severity (out of 5)	Sub team
There are uncertainties about the ISO	The coma, temperature, albedo, or position of the ISO are vastly different from what we expect	The encounter	Us not being able to obtain the images that we expect	3	3	Payload

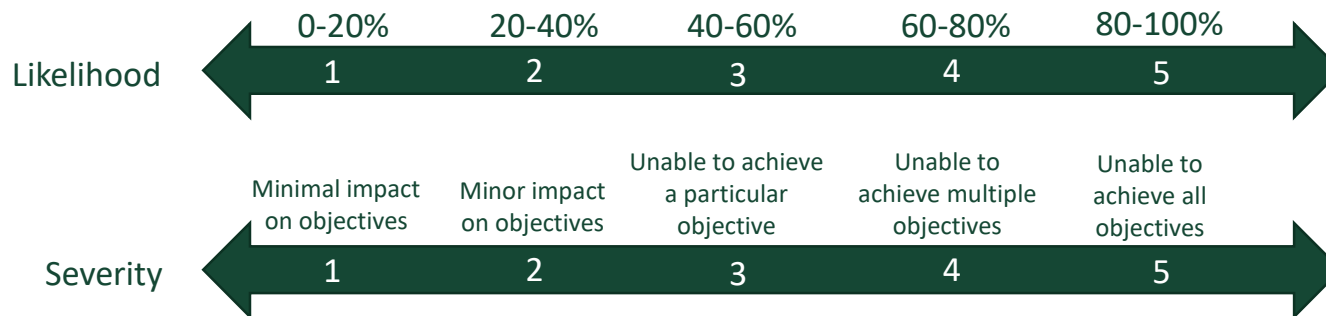

# ISO Flyby Risk - Structure

Given that...	There is a possibility of...	Adversely impacting...	Which can result in...	Likelihood (out of 5)	Severity (out of 5)	Sub team
Debris that is larger than the critical diameter of the shielding or has a very high velocity impacts the spacecraft	The payload and critical flight components being damaged	The payload and support bus shielding	Catastrophic failure	1	5	Structures

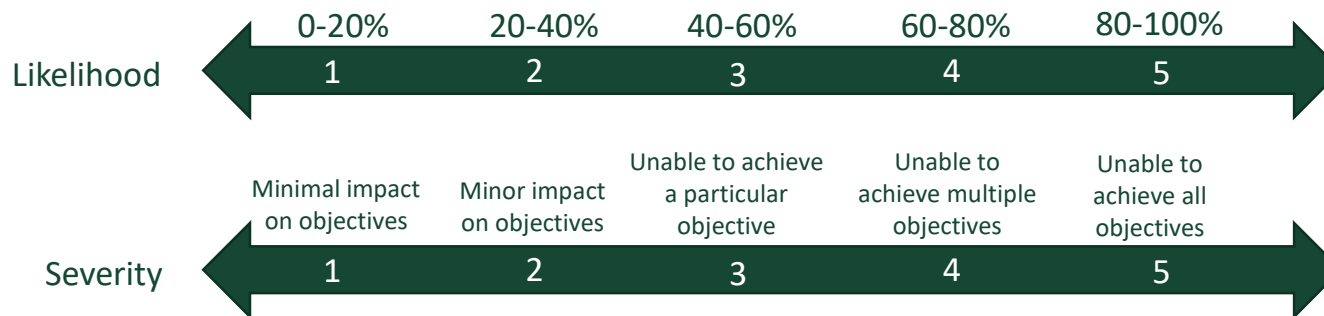

# Phase 5: Encounter

## *Applicable Level 3 Pointing & ADCS Requirements*

ID	Requirement	Driving Phase	Compliance (Y/N/M)
ADC1	The ADCS shall point the optical boresight with an accuracy of 742 arcsec during primary science acquisition	Phase 5	Y
ADC3	The ADCS shall be capable of a maximum slew acceleration of 0.0393 deg/s <sup>2</sup> during primary science acquisition.	Phase 5	Y
ADC11	The ADCS shall control the imager boresight stability to 21 arcsec/sec during primary science acquisition.	Phase 5	M

# Encounter Torques-ADCS

- Max Torque during Encounter of 9.5 Nm
- Each of our four CMGs selected can deliver 12 Nm of torque
- Models assumes a relative velocity at encounter of 13 km/s, closest approach of 400 km, and a single axis slew about x-axis
- Individual Wheel Torques and Gimbal Angles are within capability of the 12 Nm CMGs

Backup

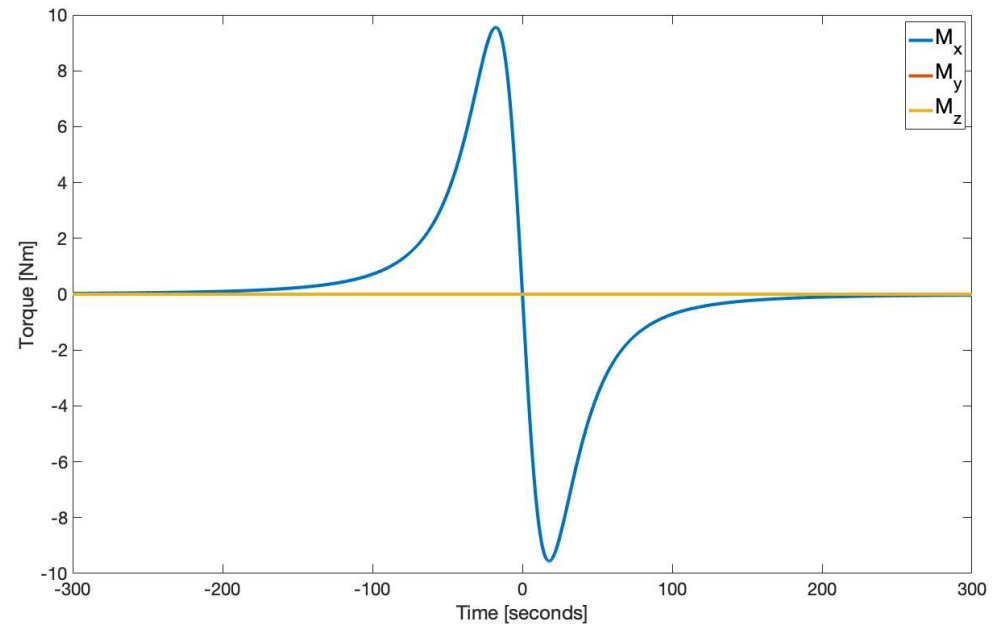

Required MED Torques during Encounter

# Pointing Budget - ADCS

Pointing Budget Description	Per-Axis Error Value (3 $\sigma$ ) [arcsec]	Radial Pointing Error (3 $\sigma$ ) [arcsec]	Radial Pointing Requirement [arcsec]	Stability Error [arcsec / s]	Stability Requirement [arcsec/s]
Encounter	580.19	741.60	741.60	12.79*	20.63

- For encounter, ADCS meets the accuracy requirements as clarified by the payload team.
- Stability error does not account for the slew performance error related to the angular velocity.
  - \*Required performance error to meet requirement: < 0.03% of maximum slew rate



# Mass, CM, and Inertia Matrix

## Mass Matrix (Total, Empty):

Moments of inertia: ( kilograms \* square meters )  
Taken at the center of mass and aligned with the output coordinate system.

$$L_{xx} = 63000, L_{yy} = 70600, L_{zz} = 14200$$

## Mass Matrix (Total, Full):

Moments of inertia: ( kilograms \* square meters )  
Taken at the center of mass and aligned with the output coordinate system.

$$L_{xx} = 67100, L_{yy} = 78300, L_{zz} = 22000$$

## Mass Matrix (Arrays):

Moments of inertia: ( kilograms \* square meters )  
Taken at the center of mass and aligned with the output coordinate system.

$$L_{xx} = 60000, L_{yy} = 64300, L_{zz} = 5000$$

(Full) CG from PAF (x = 2.5m)

CG Range  
between Empty  
and Full

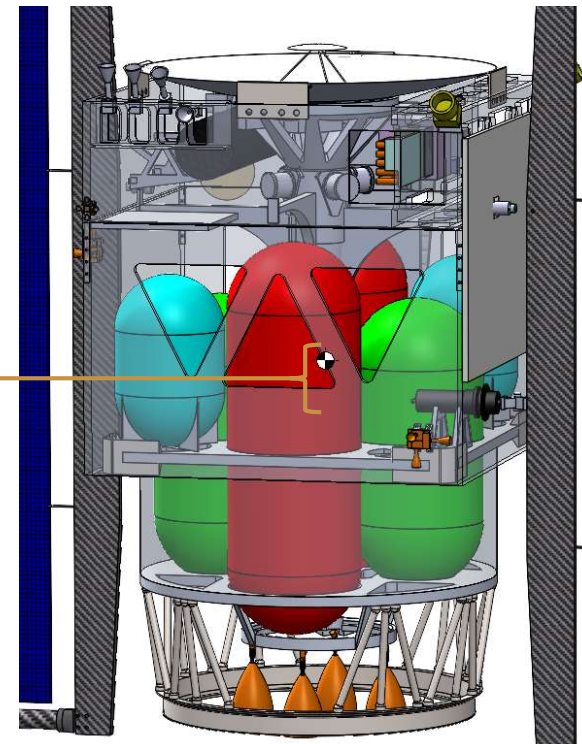
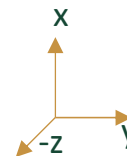

# Thermal Control– Science Instruments

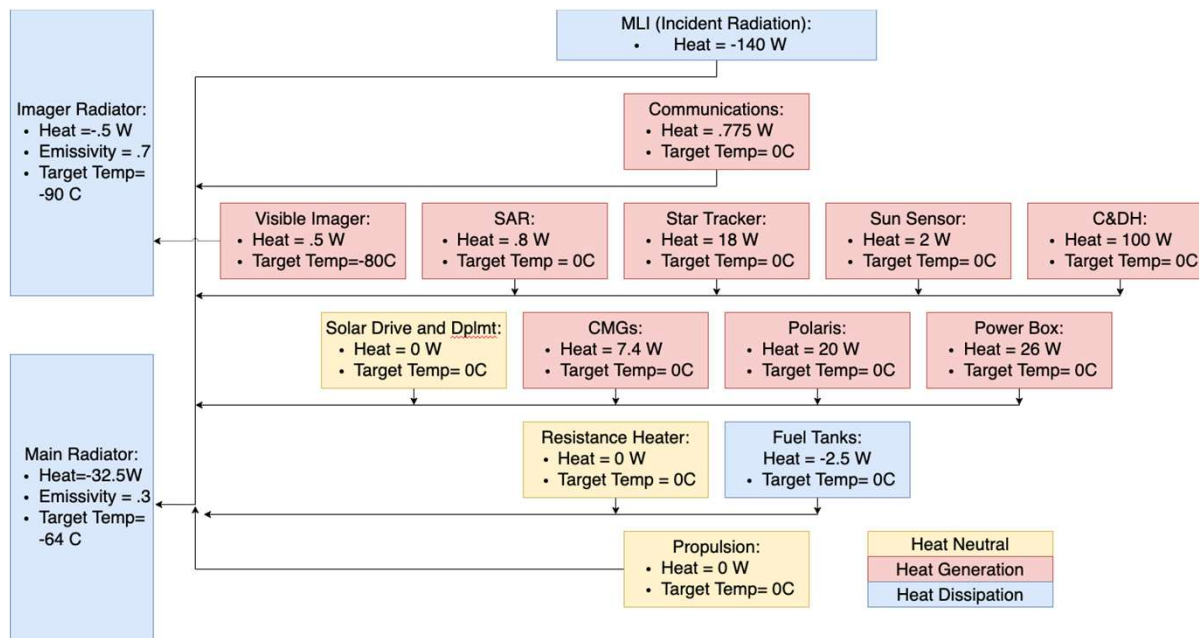

---

# Phase 6

---

Speaker: Austin I

# Phase 6: Data Downlink

## *Applicable Level 1 Requirements*

ID	Requirement
MP9	The mission shall return data to the customer no later than 9 months post collection.

## *Applicable Level 2 Requirements*

ID	Requirement
F17	The flight system shall downlink data during scheduled passes.
F18	The flight system shall transmit data to the ground system with a minimum data rate of 32.4 kbps during primary science data downlink.
F21	The flight system shall be capable of retransmitting data to the ground system.

# Phase 6: Data Downlink

## *Applicable Level 2 Ground System Requirements*

ID	Requirement
G17	The ground system shall receive data from the flight system with a data rate of at least <b>32.4 kbps</b> .
G19	The ground system shall verify that all requested data packets were received within <b>TBD</b> hours of receipt.
G37	The ground system shall establish two-way communication sessions with the flight system <b>on average of once a day for four-to-eight hours per session</b> during the post-encounter downlink mission phase.

# Phase 6: Data Downlink

## *Applicable Level 3 Telecommunication Requirements*

ID	Requirement	Driving Phase	Compliance
COM15	The communication system shall transmit science data with a minimum data rate of TBD bps.	Phase 6	Maybe
COM16	The communication system shall receive commands with a data rate of up to 2 kbps [TBC].	N/A	YES
COM22	The communication system shall have a high gain transmission EIRP of 80.89 dBW [TBC].	Phase 6	YES

# Ka-Band Downlink Budget

Spacecraft Parameter	Value
Antenna	HGA [Ka Band]
Boresight Gain [dBi]	57.88
3 dB Beamwidth [deg]	.217
Centering Frequency [GHz]	32.083
Transmission Power [W]	200
Max Pointing Error [deg]	0.10
Required BER	1E-6
Modulation Scheme	Direct BPSK
Coding	Turbo (R=½, l=5)
Required Eb/No [dB]	1.25
Nominal Link Margin [dB]	3.00

DSN Parameter	Value
Antenna	34m BWG
Boresight Gain [dBi]	79.30
Max Pointing Error [deg]	0.077
Required BER	1E-6
Modulation Scheme	Direct BPSK
Coding	Turbo (R=½, l=5)
Min Elevation Angle [deg]	10.5
Atmospheric Loss [dB]	2.00

[Backup](#)

# Phase 6: Data Downlink

## *Applicable Level 3 Power Requirements*

ID	Requirement	Driving Phase	Compliance
POW1	The power system's battery shall be capable of supplying a minimum of <b>1407 + TBD Wh</b> at end of life.	Phase 6	Yes
POW2	The power system's solar panels shall generate a minimum of <b>690 + TBD Watts</b> at end of life.	Phase 6	Yes
POW5	The power system shall provide <b>305 +/- TBD Watts</b> during system fault mode.	N/A	Yes



# Downlink Power Budget

- End of life battery system capability assumed to degrade a total of 8% over 22 years.
- Daily power demands during downlink were taken from the operational timeline to verify battery’s capability to supply power for the power deficit (~197 W ) during downlinking at a max range of 7AU

Subsystem	Component	Power Draw (W)	During Downlink (8 hours)	Recharging (16 hours)
<b>C&amp;DH</b>	C&DH Components*	100	ON	ON
<b>Comms</b>	Deep Space Transponder	13	ON	ON
	Travelling Wave Tube Amplifier K-band	335	ON	OFF
	Ultra Stable Oscillator	3	ON	ON
	Antenna	50	ON	OFF
<b>Thermal</b>	Thermal Components*	201	ON	ON
<b>ADCS</b>	ADCS Components*	186	ON	ON
<b>Total (W):</b>			<b>887</b>	<b>503</b>

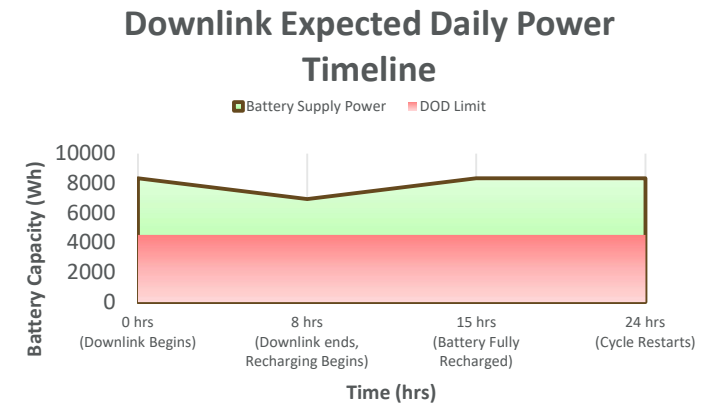

# Downlink Power Budget

Table 1. ROSA Array Specifications

Size Deployed (m <sup>2</sup> )	Size Stowed (m <sup>3</sup> )	Mass (kg)	Specific Power (W/kg)	BOL Power @ 1 AU (kW)
156.25	~1.14	407.59	112.3	45.776

- End of life array power generation taken to be reduced by ~1.25% yearly from exposure to the operating environment
  - Assumed average cosine loss is 10 degrees throughout
- Array sized for worst case scenario during most power sensitive portions of the mission
  - Initial model limit taken to be 5 AU given additional panel mass and power generation trade would be not optimal due to solar irradiance fall off.

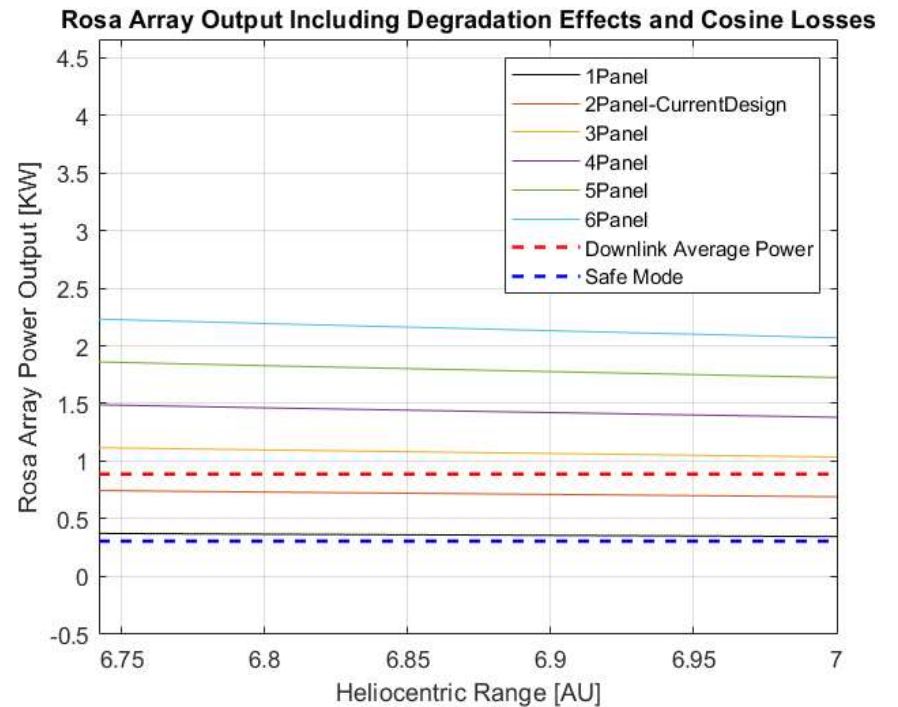

# Phase 6: Data Downlink

## *Applicable Level 3 Ground System Requirements*

ID	Requirement	Driving Phase	Compliance (Y/N/M)
GS6	The Mission Control Center shall decide whether any customer provided ISO ephemeris meets the mission capabilities	N/A	Yes
GS3	The Mission Control Center shall design and execute commands to meet the mission demands	N/A	Yes
GS9	The Data Storage and Network shall store all data of all types locally	N/A	Maybe
GS1	The Science Operations Center shall analyze science data stored in the Data Storage and Network using science models	N/A	Yes
GS2	The Science Operations Center shall provide science packages to the customer through the customer interface	N/A	Yes

# Ground Operations – Post Encounter Downlink

- Data Storage
  - Daily ground contacts for up to 10hrs
  - Data immediately transfers to GS facilities for storage and processing
- Science Product Generation
  - Science models are assembled from raw data packages
  - Complete products are generated for analysis
- Customer Interface
  - Science products packaged for customer according to accessibility requirements
  - Once packaged, products made available via required transmission methods

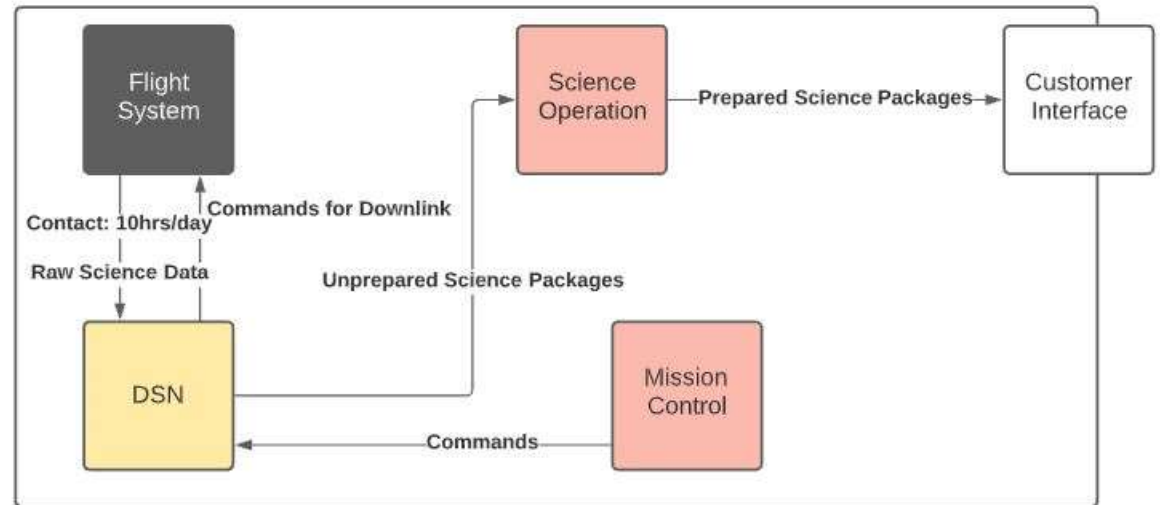

---

# Phase 7

---

Speaker: Austin I

# Individual Spacecraft Decommission

## Encounter Spacecraft (ES)

- Customer can either choose to have it attempt one of the extended mission scenarios or move directly into decommission.
- ES will be in deep space and in a heliocentric orbit (could also be a hyperbolic trajectory)
- Will just follow the decommission procedure outlined in the next slide

## Secondary Spacecraft (SES)

- Customer can either choose to have it attempt one of the extended mission scenarios or move directly into decommission.
  - If SES pursues an ISO, then it will follow ES decommission process
- After 20 years, SES health and telemetry will be analyzed and presented to customer
  - Good condition: customer can choose to decommission or outsource SES
  - Bad condition: decommission
- If at any point during 20-year span the SES is in bad condition, it will be decommissioned

Backup

# Decommission Procedure

Order	Decommission Activity
1	Dump remaining propellant from tanks and lines.
2	Vent pressurant from tanks and chambers to safe levels.
3	Turn off payload and science instrumentation.
4	Turn off ADCS and GNC equipment.
5	Turn off radiators and additional thermal equipment.
6	Turn off communications subsystem.
7	Discharge batteries and power subsystem.
8	Turn off solar arrays.

---

# Phase 7: Decommission

## *Applicable Level 2 Flight System Requirements*

ID	Requirement
F5	The flight system shall operate in the space environment for a minimum of 22 years.
F33	The flight system shall follow decommission protocol as commanded by ground.
G5	The ground system shall support the flight system for a minimum of 22 years.
G29	The ground system shall command the flight system to decommission.



# Project Life Cycle, System Integration, and Testing

Speaker: Luke

# COSMIC Project Life Cycle

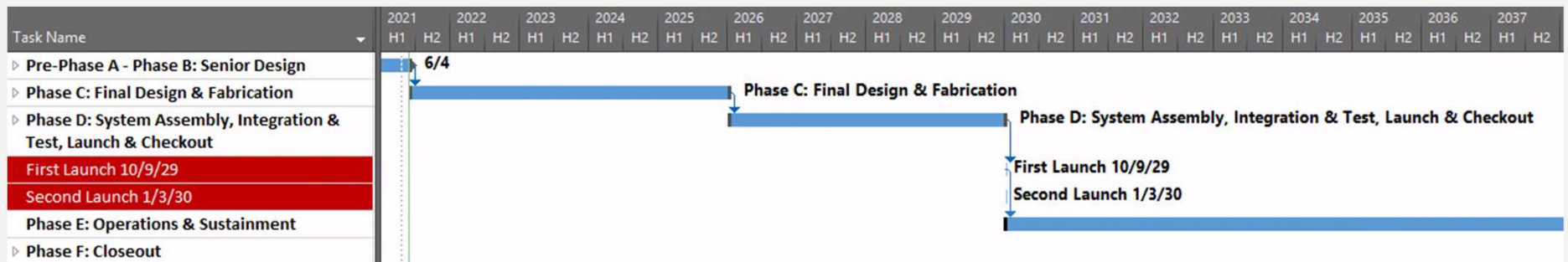

## Starting Point: NASA Program/Project Life Cycle

- NASA outlines 8 Phases, we have 5 Phases
- Pre-Phase A – Phase B: Senior Design
- Phase C: Final Design and Fabrication
- **Phase D: System Assembly, Integration & Test, Launch & Checkout**
- Phase E: Operations & Sustainment
- Phase F: Closeout

# System I&T Schedule

- Timeline overall flow
- Assumption:
  - IHM and bus modules arrive fully integrated and tested
- Any major integration will be followed by a functional test
- 20% margin built into each task duration
- Shipping and handling is built into the duration of tasks

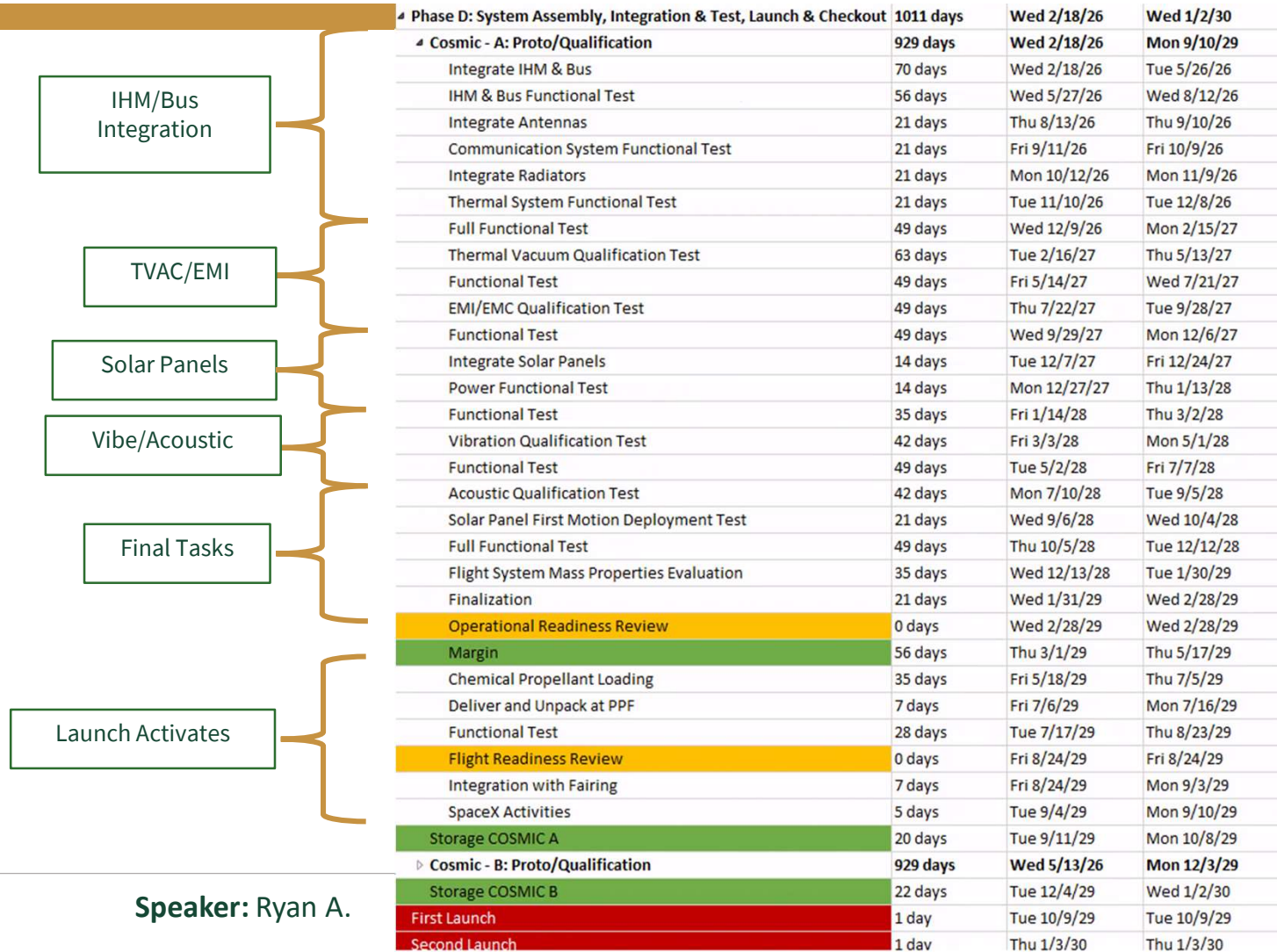

# Environmental Testing

	TVAC	EMI/ECI	VIBRATION	ACOUSTIC
C.O.S.M.I.C.-A Protoflight Qualification Standards	<ul style="list-style-type: none"> <li>T-Vac: +/- <b>10°C</b> Max./min. of predicted levels</li> <li>Thermal Cycling: +/- <b>25°C</b> Max./min. of predicted levels</li> <li>Pressure: Venting analyses performed</li> </ul>	<ul style="list-style-type: none"> <li>As specified for mission</li> <li>Generate electromagnetic compatibility report</li> </ul>	<ul style="list-style-type: none"> <li>Quasi-Static Loads: <b>1.25x</b> Limit Load for 5 cycles of 30 sec at full level per axis</li> <li>Random Vibration: MEFL + <b>3 dB</b> for 1 min/axis</li> <li>Sine Vibration: <b>1.25x</b> MEFL for 4 oct/min</li> <li>Minimum component vibrate test workmanship test: 6.8g<sub>rms</sub></li> </ul>	<ul style="list-style-type: none"> <li>MEFL + <b>3dB</b> for 1 minute (w/ minimum of 138 dB)</li> </ul>
C.O.S.M.I.C.-B Acceptance Standards	<ul style="list-style-type: none"> <li>T-Vac: +/- 5°C Max./min. of predicted levels</li> <li>Thermal Cycling: +/- 20°C Max./min. of predicted levels</li> <li>Pressure: Venting analyses performed</li> </ul>	<ul style="list-style-type: none"> <li>As specified for mission</li> <li>Generate electromagnetic compatibility report</li> </ul>	<ul style="list-style-type: none"> <li>Quasi-Static Loads: Limit Load for 5 cycles of 30 sec at full level per axis</li> <li>Random Vibration: MEFL for 1 min/axis</li> <li>Sine Vibration: MEFL for 4 oct/min</li> <li>Minimum component vibrate test workmanship test: 6.8g<sub>rms</sub></li> </ul>	<ul style="list-style-type: none"> <li>MEFL for 1 minute (w/ minimum of 138 dB)</li> </ul>

Source: NASA GEVS, NASA-STD-7001, NASA-STD-7002

# I&T – Personnel & Facilities

Personnel – 1 Shift Per Day

Teams	C.O.S.M.I.C.-A	C.O.S.M.I.C.-B
Engineers	8	8
Technicians	8	8
Total Personnel	16	16

## Facilities

- High-bay doors are 6.7 m wide
- Cranes and other lifting equipment in all three large rooms
- Supporting rooms for preparation and smaller assemblies below

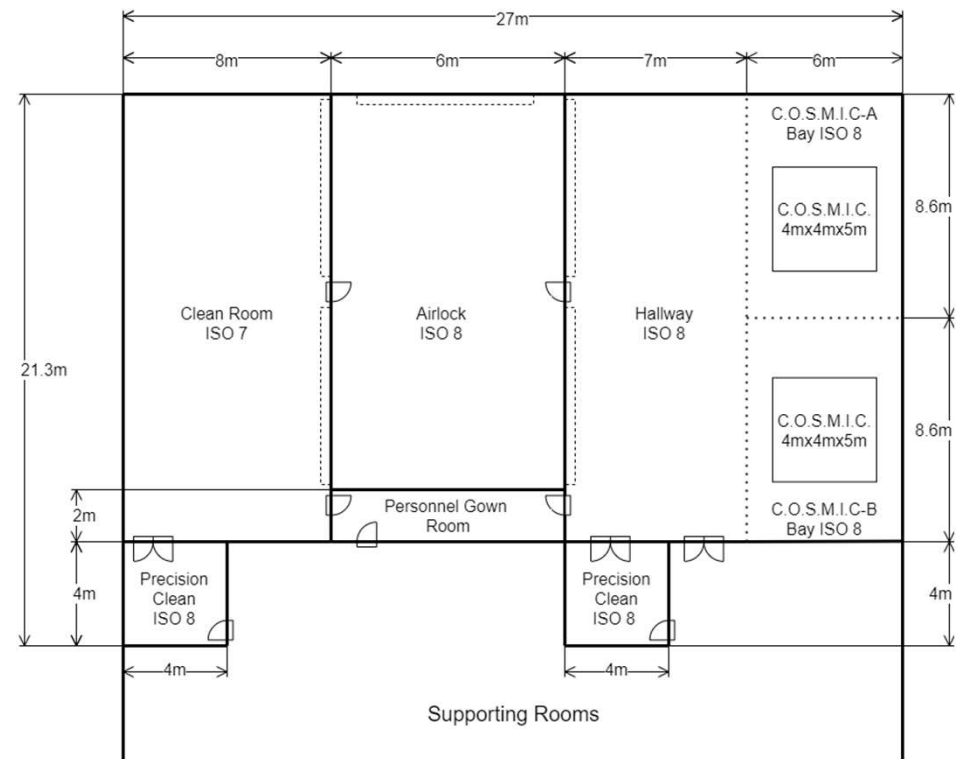

# I&T Task – IHM and Bus Module Integration Block Diagram

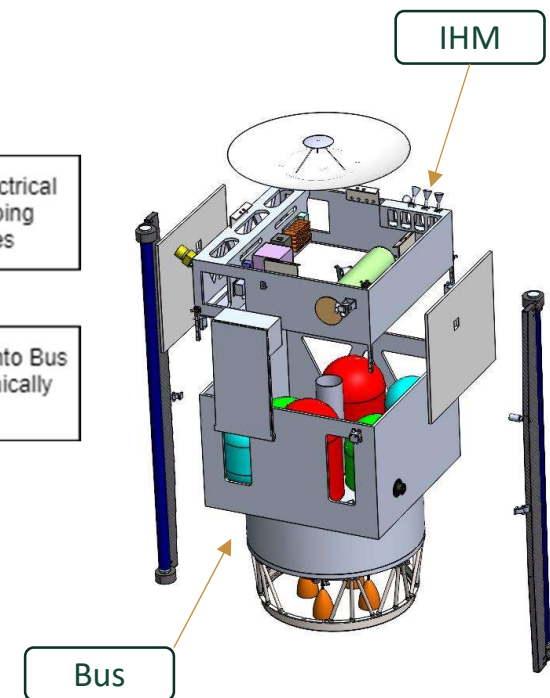
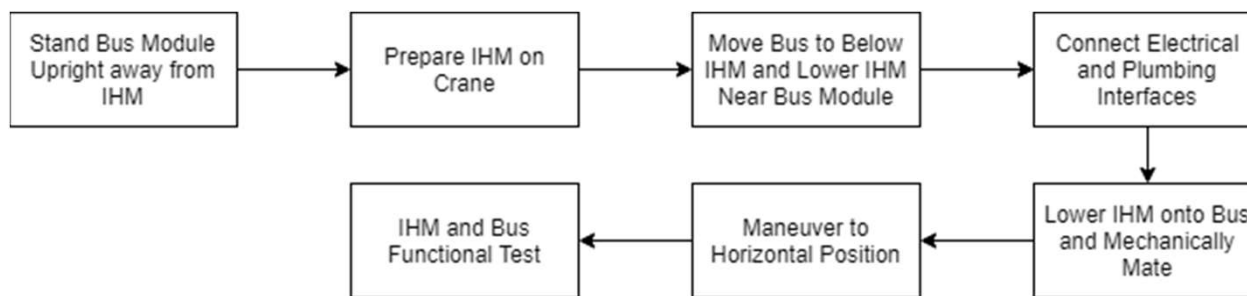

- Task occurs within the C.O.S.M.I.C. facility
- Process activities may be refined after integration of C.O.S.M.I.C.-A to optimize integration of C.O.S.M.I.C.-B

# Pre-Launch Overview

Task	Begins Days Before Launch	Description
Chemical Propellant Loading	82	<ul style="list-style-type: none"><li>• Performed at Astrotech approximately 25 miles away from launch pad</li><li>• Operations will occur over 21 work days</li></ul>
Delivery and Unpacking at PPF	47	<ul style="list-style-type: none"><li>• Non-standard service for additional time in the PPF will be utilized to perform a functional test to same standards as functional tests during I&amp;T</li></ul>
Functional Test	40	<ul style="list-style-type: none"><li>• Electrical checkout to check health of subsystems before launch</li></ul>
SpaceX Activities	7	<ul style="list-style-type: none"><li>• SpaceX takes over operations</li><li>• SpaceX integrates the spacecraft into the fairing</li><li>• Spacecraft is planned to be vertically integrated into the launch vehicle. It is not publicly disclosed how long each procedure takes</li><li>• System Checks</li><li>• Rollout to pad</li></ul>
Launch	0	

# 3<sup>rd</sup> Party Fueling



- Fueling service is about 20 miles (32 km) away from launch site
- 68 days before launch
  - Spacecraft arrives at fueling facility
- 47 days before launch
  - Spacecraft leaves fueling facility and is delivered directly to the SpaceX payload processing facility

Propellant	Amount per Spacecraft
Hydrazine	7200 kg
MON-3	7200 kg
He	10 m <sup>3</sup>

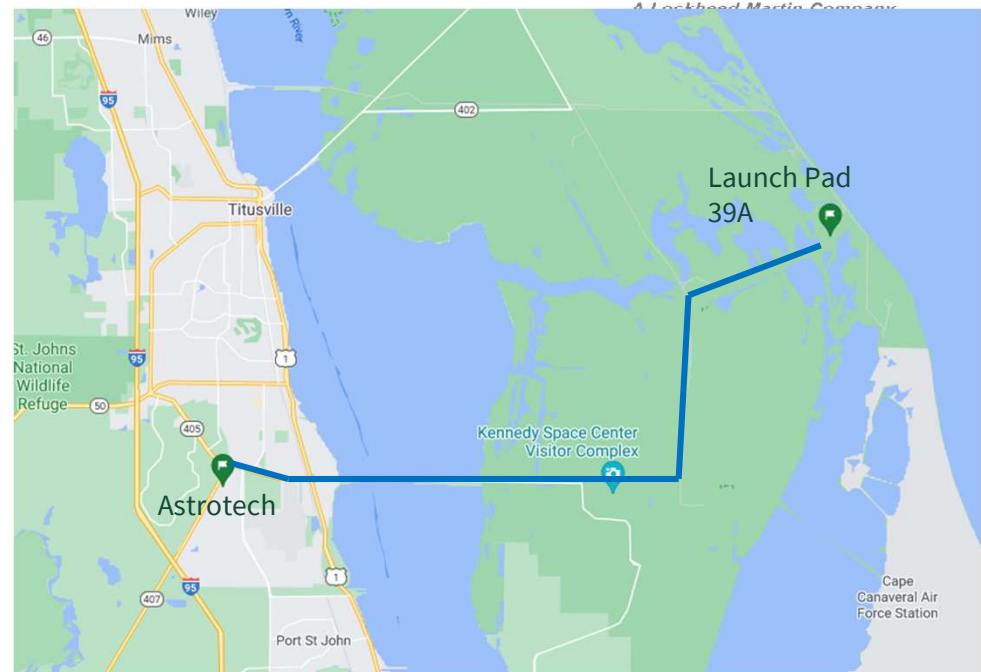



# Launch Vehicle Integration

- C.O.S.M.I.C. will first undergo integration to the PAF within SpaceX's PPF
- C.O.S.M.I.C. will then be integrated by SpaceX to the fairing in the vertical orientation
- The fairing will be horizontally integrated into Falcon Heavy inside the SpaceX hangar facility.

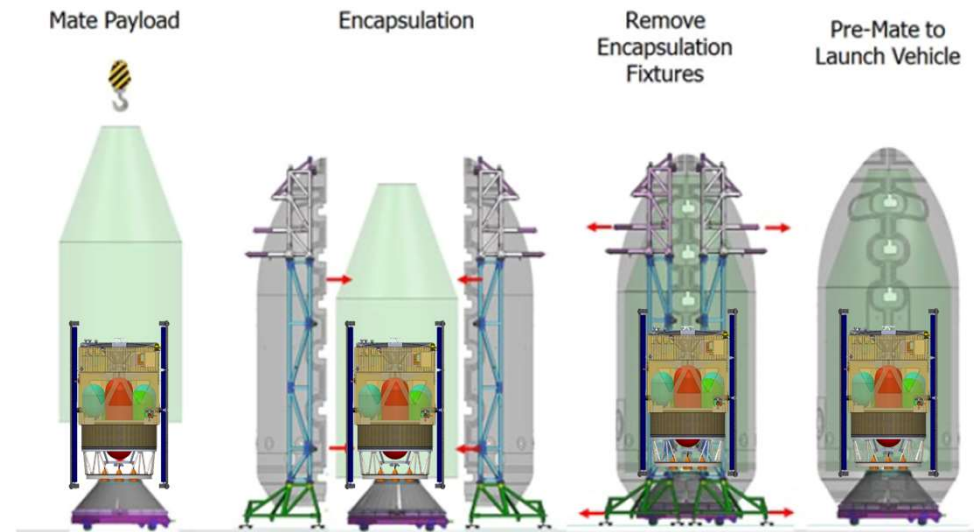

Source: SpaceX

- Once integrated onto FH, the hangar facility HVAC system is connected via a fairing air conditioning duct. Also, electrical ground support equipment is reconnected, and electrical interfaces are verified.

# Roll Out to Launch Pad

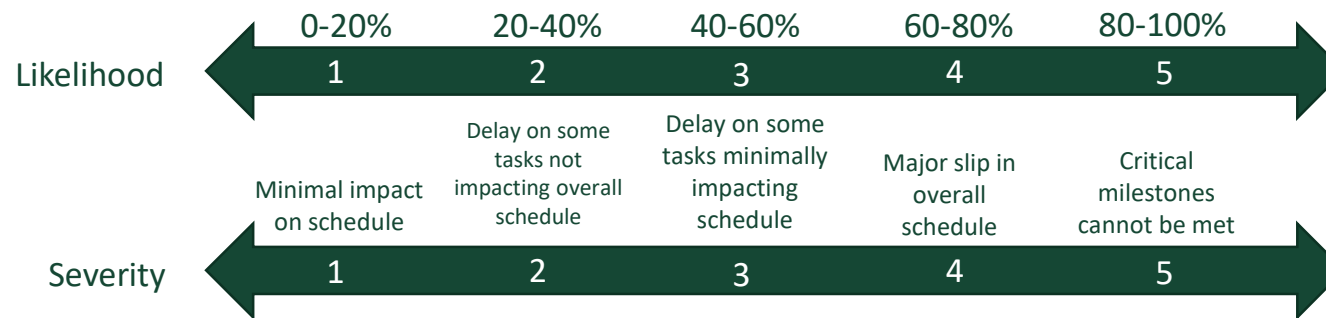

Image: SpaceX

- On the same day of launch, the flight vehicle will be rolled out to launch pad LC-39A, then erected into the vertical orientation.
- During rollout, HVAC & Electrical will be disconnected until the vehicle is at the pad.
  - However, if needed a mobile electrical unit can be used.
- Electrical Ground Support Equipment (EGSE) and HVAC connections are restored once the vehicle reaches the pad (before erection)

# Pre-Launch Risks – Launch Window

Given that...	There is a possibility of...	Adversely impacting...	Which can result in...	Likelihood (out of 5)	Severity (out of 5)	Sub team
the launch window is subject to weather or technical issues	a delay in the launch date or time	the entire mission	a delay in the readiness date	4	1 to 4	Launch Services



---

# Mission Budget

---

Speaker: Andres MA

# Budget Breakdown

System Life Cycle Phase	Direct Labor (\$ in million)	Benefits & Indirect Cost (\$ in million)	Material/Cost (\$ in million)	Total Cost per Phase (\$ in million)
Pre- Phase A to B: Senior Design	0	0	0	0
Phase C: Final Design & Fabrication	41	82	TBD	123
Phase D: System Assembly, Integration & Test, Launch & Checkout	61	122	313	496
Phase E: Operations & Sustainment	131	262	0	393
Phase F: Closeout	0.24	0.48	TBD	0.72
Total Cost per Category	233.24	466.48	313	<b>1,012.72</b>
			<b>Profit (7%):</b>	<b>70.89</b>
			<b>Total Budget:</b>	<b>1,084</b>

---

# Assumptions

- **Direct Labor Calculation:** Used salary databases to estimate average wage for the respective position in California
  - For aerospace engineers in CA, the average pay was \$60 per hour
- **Benefits & Indirect costs Calculation:** ~2 x Direct Labor
- **Material:** Due to time restraints, the team focused on large material costs such as the launch vehicle and facility cost.
- **Formula for Budget Cost:** Direct Labor + ~2 x Direct Labor + Materials + 7% Profit
  
- **As a result, we can expect COSMIC's cost to increase as the WBS & Project schedule are refined and material costs are added.**

---

# Summary

---

Speaker: Keilan R

# Design and Success Summary

## System Summary

- Two Flight Systems
- Falcon Heavy Expendable chosen as the Launch Vehicle for both Flight Systems
- Ground Station which interfaces with the Deep Space Network to communicate with the Flight System

## Mission Summary

- Purpose of the mission is to collect science data from an Interstellar Object
- Both spacecraft in pre-positioned orbits (Phase 3) for up to 20 years completing secondary objectives and waiting for a suitable ISO
- One spacecraft will fly by an ISO (Phase 5) to complete primary objectives and ISO associated secondary objectives [40% chance both spacecraft could fly to different ISOs]

## Success

The flow down of verifiable requirements is complete and proper, or, if not, an adequate plan exists for timely resolution of open items. Requirements are traceable to parent technical requirements and to mission goals and objectives

Preliminary analysis of the primary subsystems has been completed and summarized, highlighting performance and design margin challenges

TBD and TBR items are clearly identified with acceptable plans and schedule for their disposition

The preliminary design is expected to meet the requirements at an acceptable level of risk



# ISO Science Requirements Summary

ID: MP = Mission Primary, MS = Mission Secondary

ID	Traceability	Requirement	Completion*	Discussion
MP3	Solicitation A.2	The mission shall acquire visible imagery of 50% of the object's illuminated surface with a resolution of at least 5.0 meters per pixel.	Yes	Slide 107
MP4	Solicitation A.2	The mission shall acquire infrared imagery of 50% of the object's visible surface with a resolution of at least 10.0 meters per pixel.	Yes	Slide 107
MP5	Solicitation A.3, Solicitation B.1	The mission shall model 50% of the object's shape within +/- 10 meters using active measurement.	Some cases	Slide 109-111, Slide 123
MP6	Solicitation A.3	The mission shall determine the object's mean dimension within +/- 10 meters.	Yes	Slide 108
MP7	Solicitation A.4	The mission shall determine the object's spin axis within +/- 1.0 degree.	Some cases	Slide 104-105
MP8	Solicitation A.4, Customer Conversation 5/7/2021	The mission shall determine the object's rotation rate within 1%.	Yes	Slide 103
MS1	Solicitation B.1	The mission shall measure the object's dielectric constant within +/- <b>TBD</b> .	Expected	Slide 123

# Prepositioned Science Requirements Summary

ID: MS = Mission Secondary

ID	Traceability	Requirement	Completion	Discussion
MS2	Solicitation B.3, Solicitation B.5	The mission shall have a sky coverage of 0.15 % in the pre-positioned orbit.	Yes	Slides 45-66
MS3	Solicitation B.3	The mission shall observe heliocentric orbiting bodies.	Yes	Slides 45-66
MS4	Solicitation B.5	The mission shall acquire exoplanet photometry of a minimum of 1 star system.	Yes	Slides 45-66

# Additional Mission Requirements Summary

ID: MP = Mission Primary

ID	Traceability	Requirement	Completion	Discussion
MP1	Solicitation	The mission shall be ready to react to an ISO no later than 12/31/2030.	Yes	150-151
MP2	Solicitation	The mission shall have an 80% likelihood of reaching at least 1 object with the parameters specified in Table 1.0 within 20 years of its readiness date.	Expected	11-12, 46
MP9	Customer Conversation 1/8/2021	The mission shall return data to the customer no later than 9 months post collection.	Yes	136-144
MP10	Customer Conversation 1/8/2021	The mission shall communicate with the deep space network.	Yes	20, 66, 136-144

A light green topographic map background with contour lines, partially visible behind the text.

Thank you!  
End of Day 2



CAL POLY

A light green topographic map background with contour lines, partially visible behind the text.

# Support Slides



**CAL POLY**

---

# Project Management

---



**David Schreiber**



**Keilan Ramirez**



**Luke Kutz**



**Natalia Cieply**

**Andres Mendoza Arteaga**

---

# System Engineering

---

# Subsystem Breakdown

[Back to Mass Breakdown](#)

Subsystem	Components
Payload	SAR, Imager System
Propulsion	R-4D-15 HiPAT™ 445 N (4 thrusters), Propellant Tanks, Plumbing & valves, Propellant, Pressurant
Power	ROSA Panels (x2) , Battery, Solar Drive Assemblies (x2), Solar Array Drive Assembly Electronics, PCE (Power Control Electronics) - Power Box, Wiring Harness
Comms	High Gain Antenna, Medium Gain Antenna (x2), Low Gain Antenna (x2), Deep Space Transponder (x2), Ka-Band Travelling Wave Tube (x2), X-band Travelling Wave Tube (x2), Ultra Stable Oscillator, Diplexer (x2), Cabling/Waveguide, Switches, Hybrid Coupler
Thermal	Radiators, Chem Prop heaters, Heat Pipes, Thermal Switches, Thermal Isolators, MLI Blankets, Louvers, Pump Module, Louvers, thermoelectric coolers
GNC	APIC (OPNAV Camera)
ADCS	CMGs (x4) (Blue Canyon CMG-12) - baseline CMGs, A-STR (Star Tracker), CSS (Course Sun Sensor x4), IMU(Polaris x2)
Structures	Spacecraft Attachment Fitting, Hook Integration Mount, Crane Integration Mount, Solar Array Drive Assemblies (x2), MROSA Deployment Structure (x2), Lower Structure Walls, Upper Structure Walls, Routing Platforms, Electronics Plate, Electronics Floor, Imager Mounts, Center Column, Upper and Lower Tank Plate, Thruster Structure, Brackets, Launch Support Structure
C&DH	Combined Enclosure

Note: sizing of the propellant includes a 10% margin and so it doesn't include a specific MGA percentage



# Extended Mission Scenarios

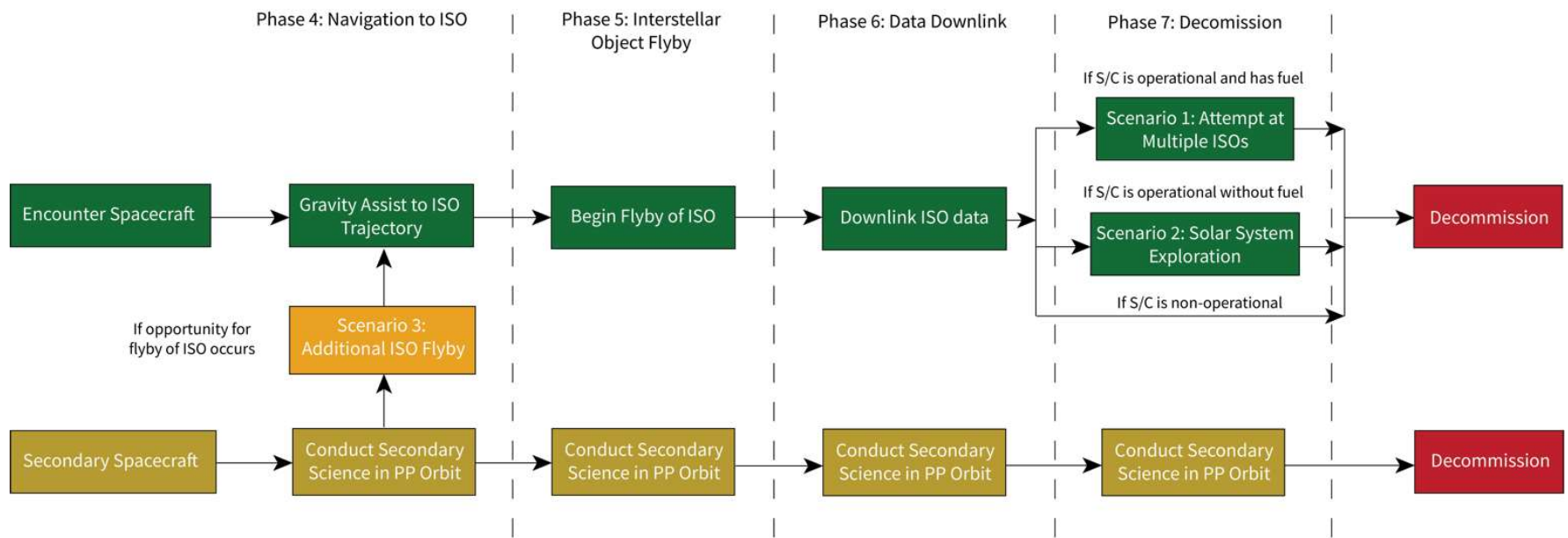

Back

---

# Risk Statement

A concise description of an individual risk that can be understood and acted upon

**“Given that [CONDITION] there is a possibility of [DEPARTURE] adversely impacting [ASSET], which can result in [CONSEQUENCE] ”**

- Condition: a single phrase that describes the current key fact-based situation or environment that is causing concern, doubt, anxiety, or uneasiness
- Departure: describes a possible change from the (agency, program, project, or activity) baseline project plan. It is an undesired event that is made credible or more likely as a result of the CONDITION
- Asset: an element of the organizational unit portfolio (OUP) (analogous to a WBS). It represents the primary source that is affected by the individual risk.
- Consequence: a single phrase that describes the foreseeable, credible negative impact(s) on the organizational unit’s ability to meet its performance requirements

# Risk Likelihood and Severity

5	5	10	15	20	25
4	4	8	12	16	20
3	3	6	9	12	15
2	2	4	6	8	10
1	1	2	3	4	5
	1	2	3	4	5

### Severity Scale

- Impact on performance
  1. Minimal impact on goals
  2. Minor impact on goals
  3. Unable to achieve a particular goal
  4. Unable to achieve multiple goals
  5. Unable to achieve the overall goal
- Impact on schedule
  1. Minimal impact on schedule
  2. Delay on some tasks not impacting overall schedule
  3. Delay on some tasks minimally impacting overall schedule
  4. Major slip in overall schedule
  5. Critical milestones cannot be met

### Likelihood Scale

1. Not likely (under 20% probability of happening)
2. Not very likely (between 20% and 40% probability of happening)
3. Likely (between 40% and 60% probability of happening)
4. Highly likely (between 60% and 80% probability of happening)
5. Near certainty (over 80% probability of happening)

---

# Concept of Operations

---



Austin Iannitti

Sean Thompson

---

# Requirements

---



Bailey Garrett

Sydney Retzlaff

[Back to main!](#)

# Table 1: ISO Characteristics

ISO Characteristic	Parameters
Inbound Distance	3AU
Detection	Uniform Distribution
Eccentricity	0.99-3.50
Perihelion	0.3 AU - 2 AU
Inclination	0-180 deg
Argument of Perihelion	0.05 or higher
Geometric Albedo	1.0-1.5 km
Mean Dimension	+/- 10 m

# Figure 1: Falcon Heavy Launch Vehicle Fairing

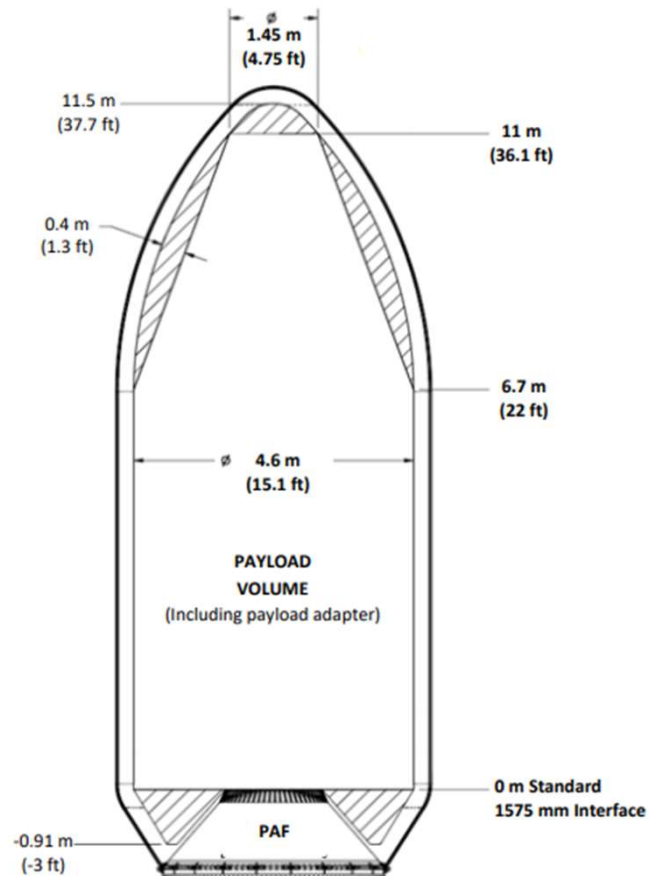

[Back to main!](#)

Source: Falcon Heavy User Guide Figure 5-1  
[https://www.spacex.com/media/falcon\\_users\\_guide\\_042020.pdf](https://www.spacex.com/media/falcon_users_guide_042020.pdf)

# Table 7: Fault Mode Causes

Fault Mode Causes
C&DH does not receive confirmation that a mission critical command was performed.
C&DH does not receive conformation on any attitude commands.
C&DH does not receive conformation on any positioning commands.
C&DH reboots for any unexpected reason.
For power cycle issues.
If a health sensor is outside of survival range.
Following separation from the launch vehicle.



[Back to main!](#)

# Figure 2: Mass of Payload vs. C3 Values

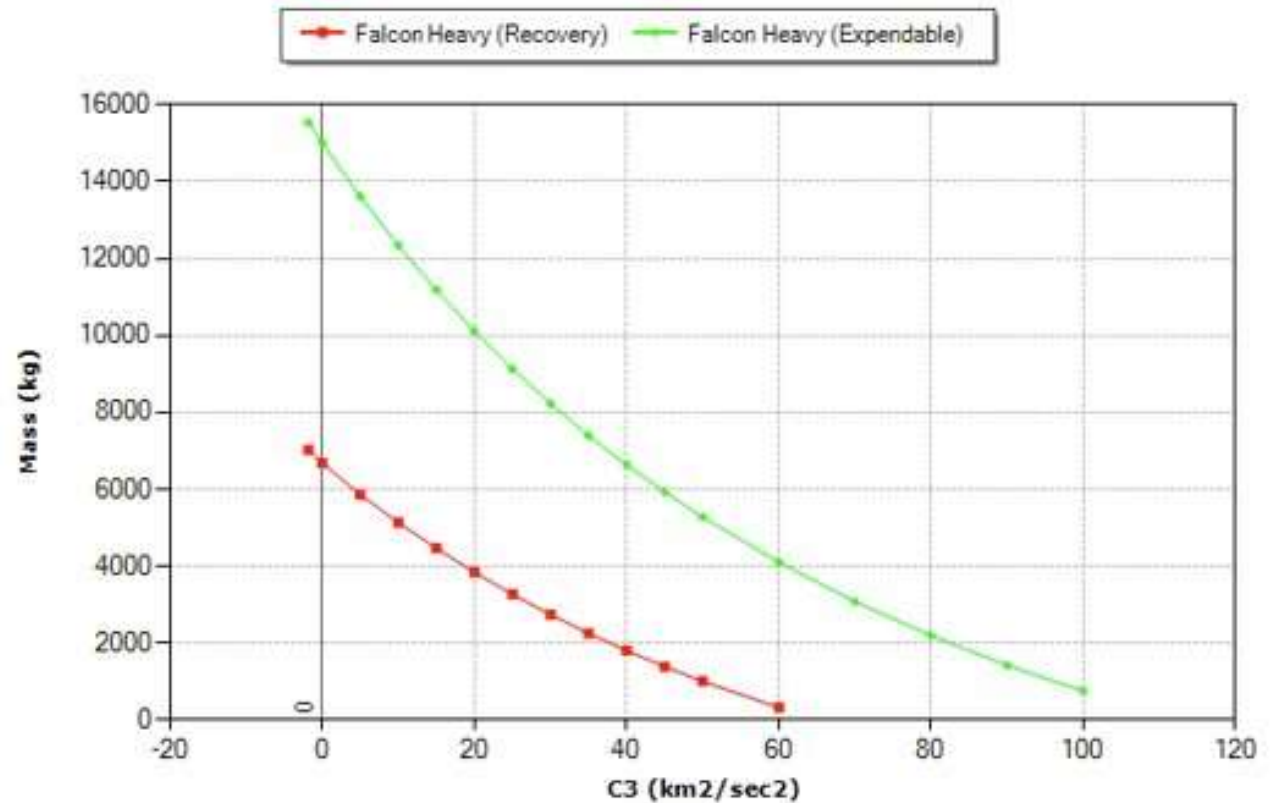

[Back to main!](#)

# Table 6.1: Initial Emplacement Orbit Definition

Initial Emplacement Orbital Elements by Spacecraft					
	Semi-Major Axis (AU)	Eccentricity	Inclination (°)	Right Ascension of the Ascending Node (°)	Argument of Periapsis (°)
Spacecraft 1	1	0.0167	2.5	103	0
Spacecraft 2	1	0.0167	2.5	193	270

[Back to main!](#)

# Table 6.2: Pre-Positioned Orbit Definition

Prepositioned Orbital Elements by Spacecraft					
	Semi-Major Axis (AU)	Eccentricity	Inclination (°)	Right Ascension of the Ascending Node (°)	Argument of Periapsis (°)
Spacecraft 1	1	0.0167	21	103	0
Spacecraft 2	1	0.0167	21	193	270

---

# Orbits

---

Christian Fuller

Ryan Meisberger



Jack Kelly

Jordan Watt

Evan Agarwal

Dominick Bologna

# Orbit Case Studies: ISO A

- ISO COEs
  - Eccentricity: 1.65
  - Radius of Perihelion: 1.50 AU
  - Inclination: 93.94 deg
  - RAAN: 71.11 deg
  - Argument of Perihelion: 45.03 deg
- Delta-V
  - Total DV: 4.494 km/s
  - Burn 1: 0.017 km/s
  - Burn 2: 0.018 km/s
  - Burn 3: 4.459 km/s
- Encounter
  - Relative Velocity to ISO: 8.541 km/s
- Flyby
  - Earth Flyby Altitude: 14848 km

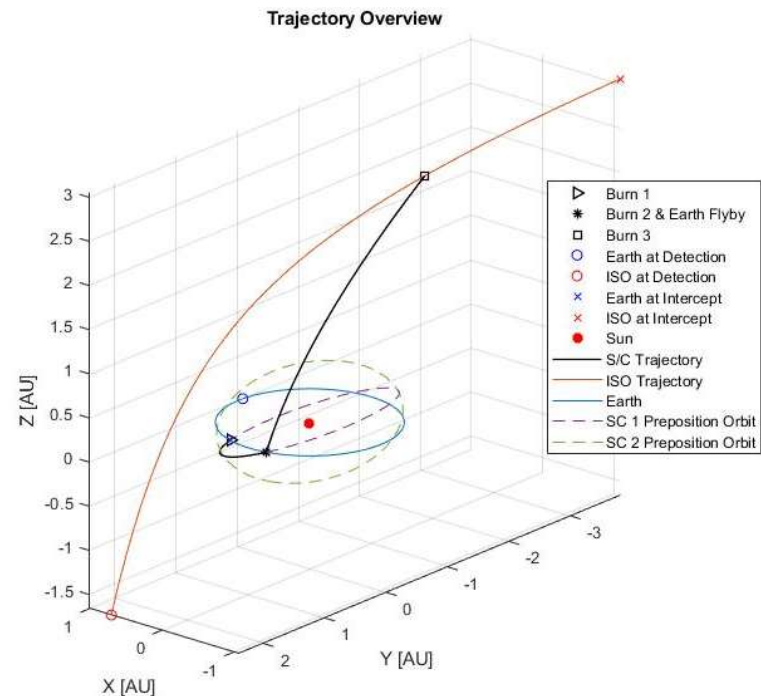

# Orbit Case Studies: ISO A

## Transfer Characteristics

- Day of ISO Detection: Sept 19, 2044
- Transfer Duration: 186 days

## 10 Days Before Intercept

- Apparent Magnitude: 21.77
- Phase Angle: 114.48 deg

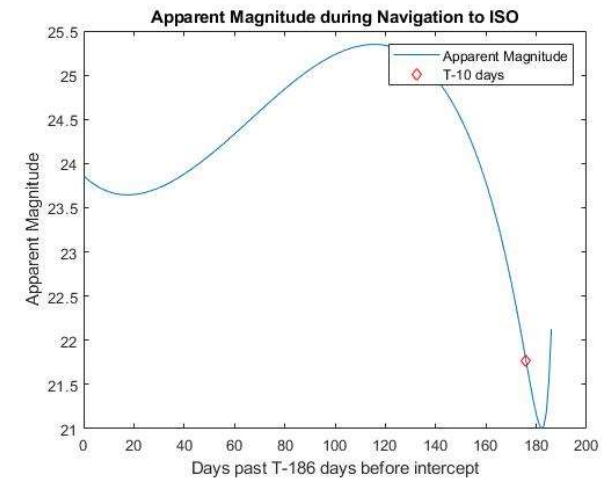
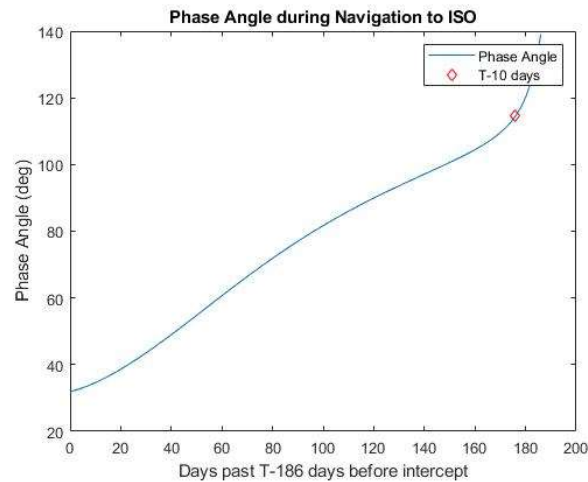
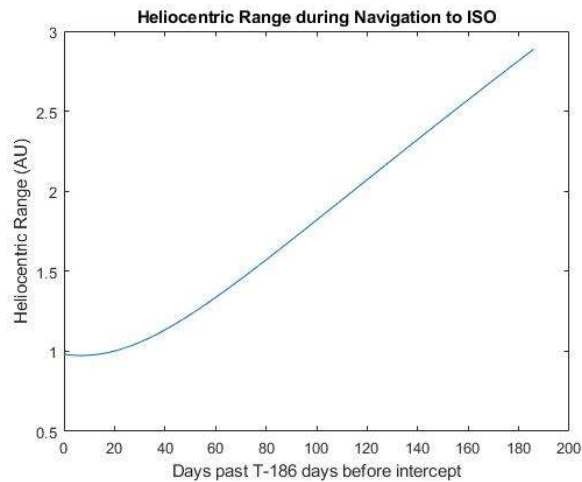

# Orbit Case Studies: ISO B

- ISO COEs
  - Eccentricity: 3.07
  - Radius of Perihelion: 1.38 AU
  - Inclination: 71.26 deg
  - RAAN: 117.47 deg
  - Argument of Perihelion: 220.86 deg
- Delta-V
  - Total DV: 4.387 km/s
  - Burn 1: 0.073 km/s
  - Burn 2: 0.073 km/s
  - Burn 3: 4.241 km/s
- Encounter
  - Relative Velocity to ISO: 10.239 km/s
- Flyby
  - Earth Flyby Altitude: 7353 km

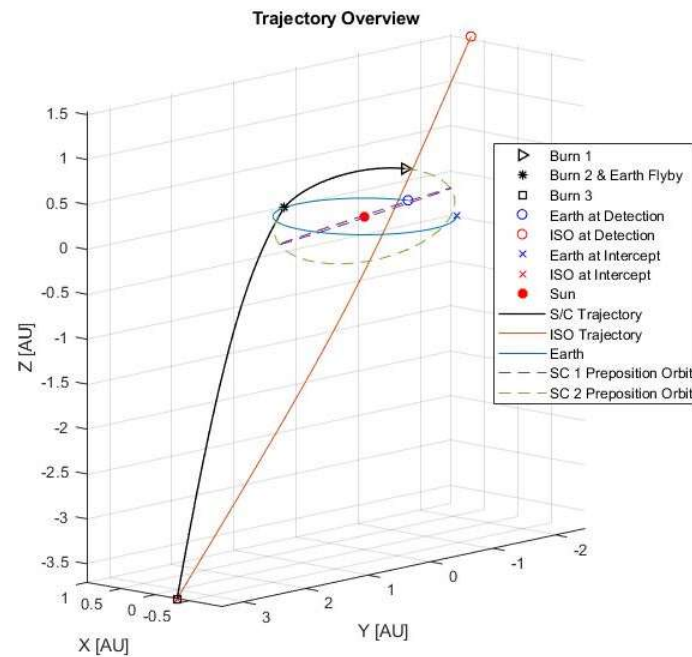

# Orbit Case Studies: ISO B

## Transfer Characteristics

- Day of ISO Detection: Dec 29, 2032
- Transfer Duration: 213 days

## 10 Days Before Intercept

- Apparent Magnitude: 27.12
- Phase Angle: 125.71 deg

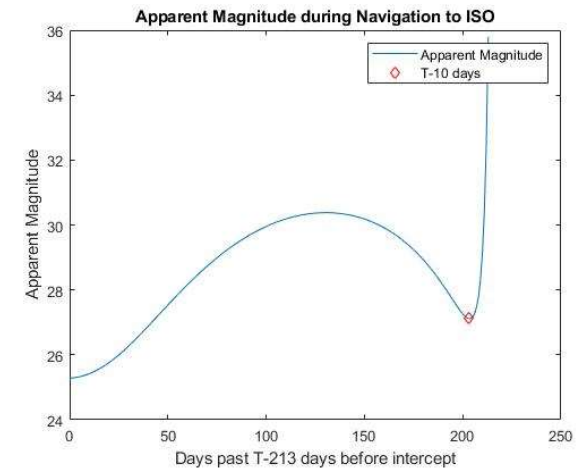
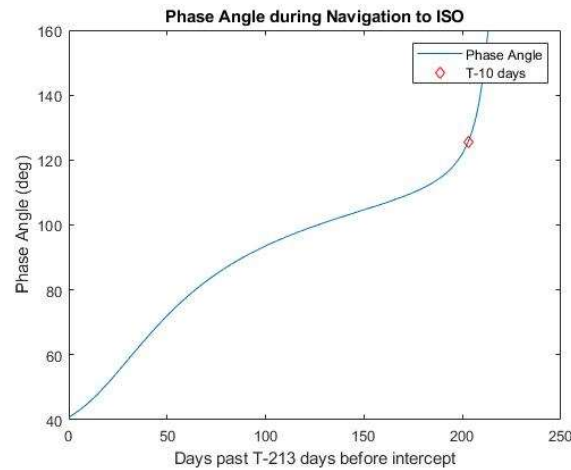
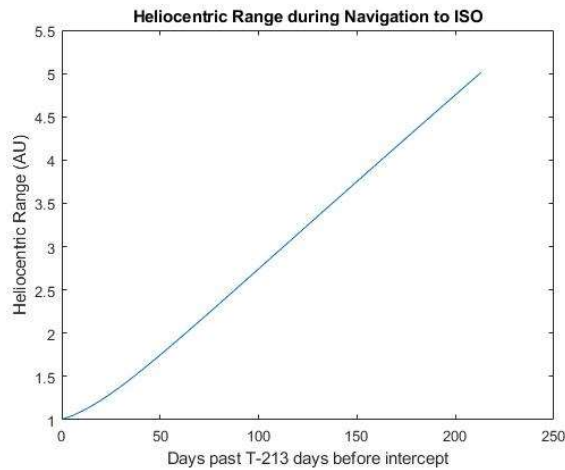



# Orbit Case Studies: ISO C

- ISO COEs
  - Eccentricity: 2.18
  - Radius of Perihelion: 1.81 AU
  - Inclination: 144.04 deg
  - RAAN: 131.07 deg
  - Argument of Perihelion: 30.20 deg
- Delta-V
  - Total DV: 4.108 km/s
  - Burn 1: 0.310 km/s
  - Burn 2: 0.312 km/s
  - Burn 3: 3.486 km/s
- Encounter
  - Relative Velocity to ISO: 12.710 km/s
- Flyby
  - Earth Flyby Altitude: 6172 km

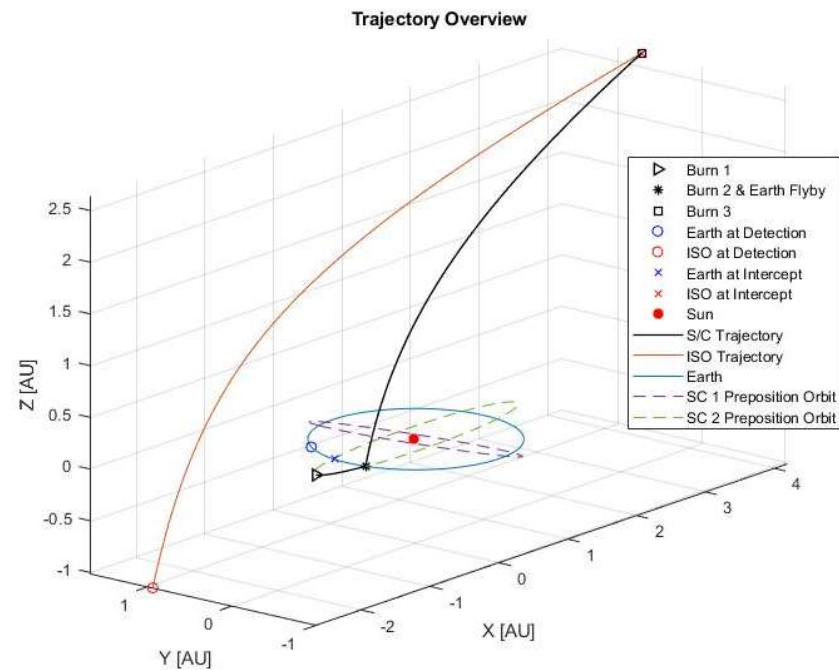

# Orbit Case Studies: ISO C

## Transfer Characteristics

- Day of ISO Detection: Feb 15, 2030
- Transfer Duration: 344 days

## 10 Days Before Intercept

- Apparent Magnitude: 26.62
- Phase Angle: 121.65 deg

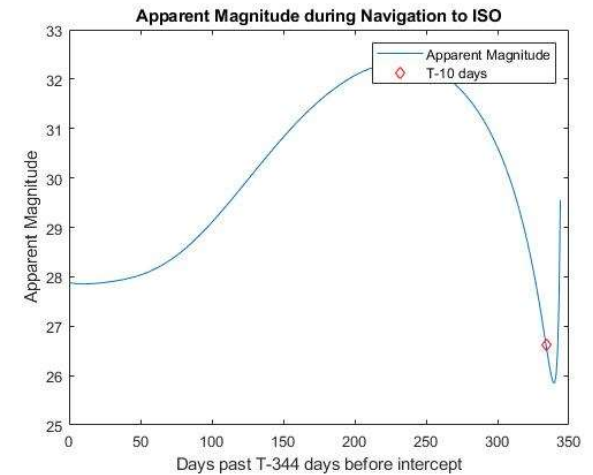
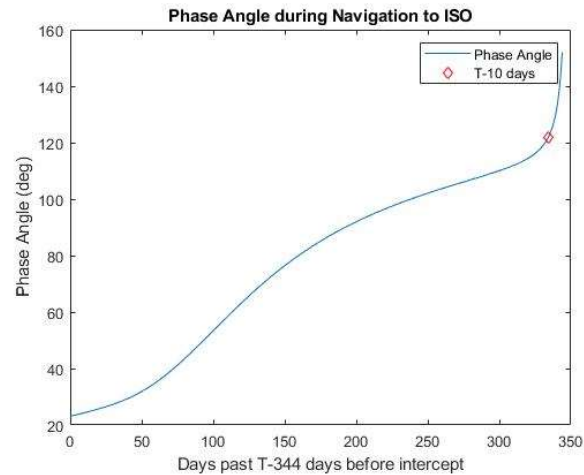
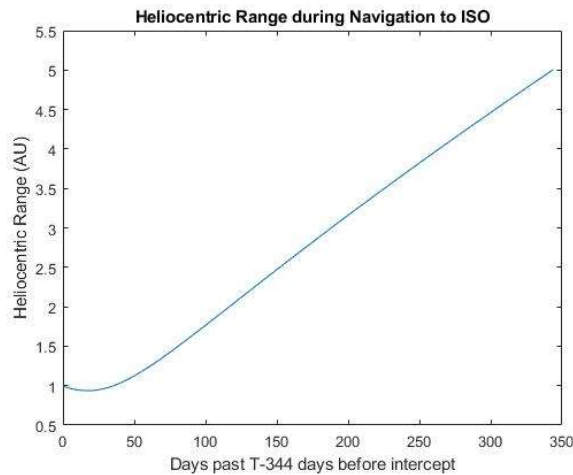

# Orbital Simulation Assumptions

Assumption	Reasoning
Only 1 chance at ISO detection per day	Daily checks is sufficiently fine resolution given mission length (up to 20 years). Evaluating more frequently would strain computational resources for diminishing returns.
Probability of ISO detection averages to 1/year	Solicitation states 1/year ISO detection rate
ISO detected at 3 AU heliocentric inbound	Solicitation states customer will identify ISO at 3 AU
Spacecraft are in constant inclination orbits	The final orbital details are to be determined and may involve small changes (<2°) to inclination due to high-altitude Earth flybys. The variation is expected to be minor, but this remains an open action moving forward.
Perturbations are neglected	Perturbations from Solar Radiation Pressure and N-Body effects are expected to be minor. As such they are neglected in the simulation for the sake of processing speed
Impulsive burns	Given the time scales and chemical propulsion system, impulsive burns are suitable for modeling at his level.
Earth modeled as a point mass	The distances involved sufficiently dwarf Earth's Sphere of Influence and the gravity assist functions operate independently of this assumption. The difference is expected to be minor, but this remains an open action moving forward

# Orbital Simulation Inputs

Input Categories	Values	Reasoning
Mission Start Date	01/01/2031	Solicitation directs mission readiness by 12/31/2030
Mission Length	7305 days	Solicitation directs mission completion by 12/31/2050
Propagation Time Step	1 day	For time scales involved, 1 day is sufficiently fine resolution
Transfer Evaluation Time Step	1 day	Generates more data for evaluation
Min Spacecraft Distance from Sun	0.5 AU	Preliminary value set by structures
Max Heliocentric Encounter Distance	5 AU	Set by GNC, driven by restrictions in Optical Navigation
Max Relative Speed at Encounter	13 km/s	Set by Encounter lead, driven by Payload and ADCS needs
Min Time From ISO Detection to 1 <sup>st</sup> Burn	3 days	Arbitrary, to be revisited with input from Ground Systems
Max Time From 1 <sup>st</sup> Burn to Gravity Assist	91 days	Arbitrary, to be revisited in light of station-keeping needs
Min Gravity Assist Altitude	1000 km	Chosen to avoid atmospheric effects, especially drag, as well as concentrations of Low Earth Orbit satellites

# Orbital Simulation Process

1. Step through each mission day and determine if an ISO is detected
  1. Once an ISO is detected, generate its orbital elements randomly in accordance with the solicitation
  2. Determine the ISO's initial state and propagate it until it reaches the outer bound set for Encounter
  3. Determine the next gravity assist opportunity from day of detection
    1. For each transfer timestep calculate the trajectory from Earth to the ISO
      1. Use the difference in velocities at the ISO to determine the final burn needed to achieve the relative encounter speed
      2. Use the required trajectory velocity at Earth as the outbound velocity of the gravity assist and determine the necessary inbound velocity required to achieve it
      3. Determine the spacecraft trajectory from its pre-positioned orbit leaving location to the gravity assist
      4. Determine burns required to enter trajectory to gravity assist and to begin gravity assist once at Earth SOI
      5. Sum DV magnitudes of all three burns as total cost of achieving the given encounter
    2. Repeat 1.3.1 until ISO is passed the outer bound set for encounter
    3. Store lowest total DV cost for the given gravity assist
  4. Repeat 1.3 for each gravity assist opportunity while the ISO is within the outer bound set for encounter
  5. Store lowest total DV cost for the given ISO
2. Repeat 1 until mission length is reached
3. Store lowest DV cost for the mission

Note: All generation, propagation, and evaluation data generated by the simulator is saved and available for post-processing and analysis.

# Transfer Time

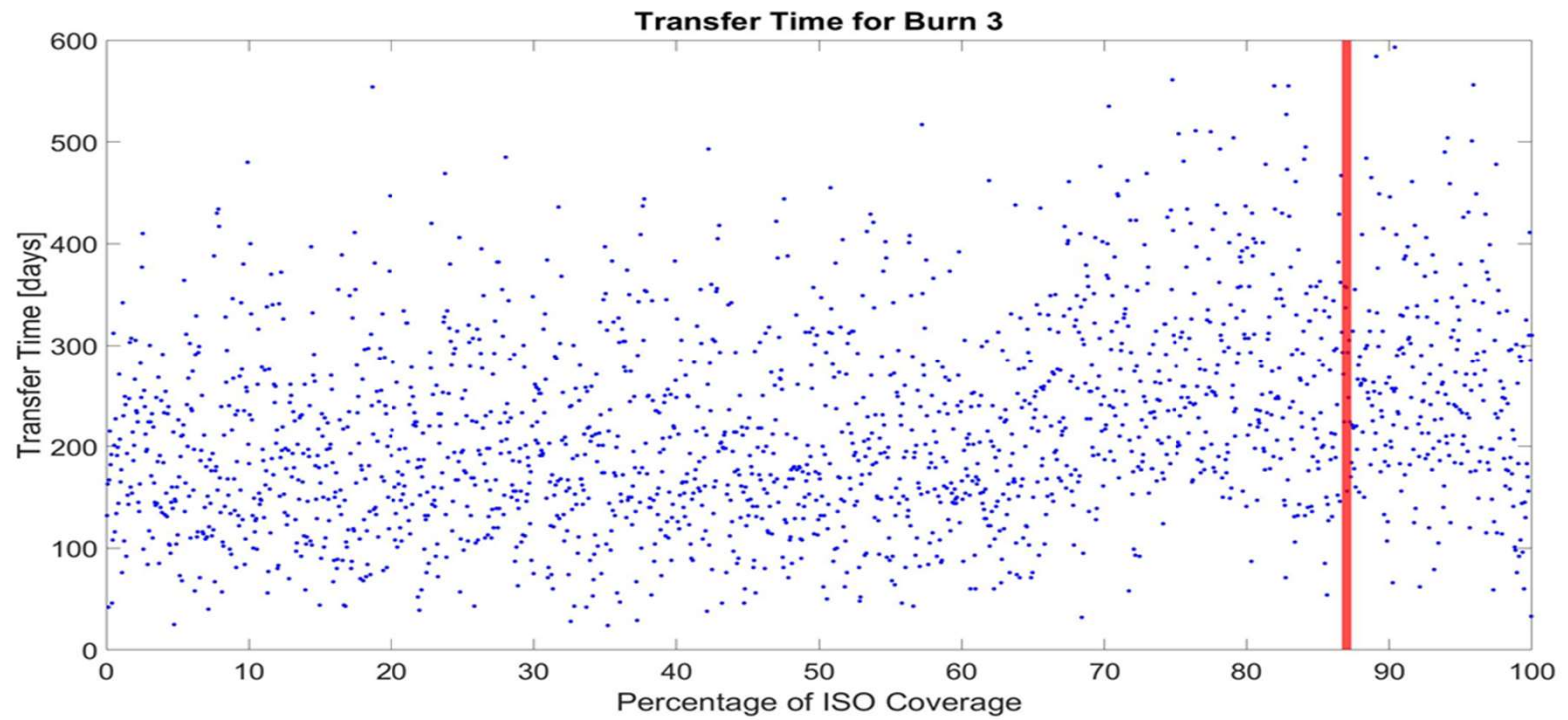

---

# Propulsion

---

Speaker: C. Larkin

# Tank Sizing

- Tanks were sized based on R. Meisberger's mass model
- 1.5x burst factor used per AFSPCMAN 91-710
- Propellant tanks:
  - 21.3 bar MEOP
    - Driven by primary prop max inlet pressure
  - 21.3 bar x 1.5 = 34.5 bar MAWP
  - 300 K Hydrazine/290 K MON-3
- Pressurant tanks:
  - 200 bar MEOP
    - Driven by need to keep tanks at 21.3 bar at burnout
  - 200 bar x 1.5 = 300 bar MAWP
  - 300 K Helium

Fluid	Total Volume [m3]	MEOP [bar]	Temp [K]	Fluid Mass [kg]	Tank Mass [kg]
He	1.2	200	300	18	189
Hydrazine	5.8	21.3	300	5926	216
MON-3	3.7	21.3	290	5408	130

12.3.3. Flight Hardware Metallic Pressure Vessels with Brittle Fracture or Hazardous LBB Failure Mode.

12.3.3.1. Flight Hardware Metallic Pressure Vessels with Brittle Fracture or Hazardous LBB Failure Mode Factor of Safety Requirements.

12.3.3.1.1. Safe-life design methodology based on fracture mechanics techniques shall be used to establish the appropriate design factor of safety and the associated proof factor for metallic pressure vessels that exhibit brittle fracture or hazardous LBB failure mode.

12.3.3.1.2. The loading spectra, material strengths, fracture toughness, and flaw growth rates of the parent material and weldments, test program requirements, stress levels, and the compatibility of the structural materials with the thermal and chemical environments expected in service shall be taken into consideration.

12.3.3.1.3. Nominal values of fracture toughness and flaw growth rate data corresponding to each alloy system, temper, and product form shall be used along with a life factor of 4 on specified service life in establishing the design factor of safety and the associated proof factor.

12.3.3.1.4. Unless otherwise specified, the minimum burst factor shall be 1.5.



# Zero-G Propellant Management

- Propellant management is achieved using a surface-tension style propellant management device (PMD)
  - Using a surface-tension style PMD over a positive-expulsion device such as a diaphragm allows multiple pressure cycles to be performed on the propellant tank without having to worry about damage the diaphragm. Piston-style devices allow multiple pressure cycles but are heavier.
  - A combination of vanes and a sponge is used to ensure that we always have propellant ready to go
  - Mass flow rates are low for the secondary propulsion system, so it is unlikely to deplete the sponge's propellant capabilities during ADCS "desaturation" burns. If larger burns are required, a settling burn may be performed to allow the sponge to resaturate with propellant.

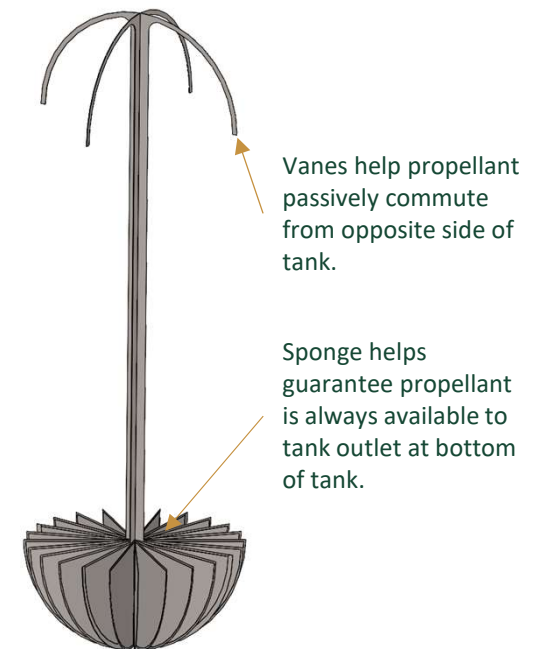

# Ullage Calculations

- Because the high-pressure helium system is sealed off using a pyrotechnic valve prior to Phase 4, the Helium tank isn't able to be used to pressurize the propellant tanks.
- In order to allow propellant tanks to function during orbital adjustments/stationkeeping, extra ullage space (~10%) was added to both tanks to allow the propulsion system to perform as a blowdown system prior to Phase 4.
- Ullage calculations were based upon secondary propulsion, but similar sizing was added to the oxidizer tank as well to allow high-thrust contingencies.

# Leak Rates

- Helium leakage rates were calculated to verify pressurant mass margin over the 20+ year mission.
- Welded joints were analyzed as leaking  $1e-6$  scc/s GHe, threaded joints (AN) were analyzed as leaking  $1e-4$  scc/s GHe
- Initial findings found leakages of upwards of 7 kg over 21 years, which exceeded out mass margin of 6 kg. Pyrotechnic valves were added to isolate the high-pressure Helium system prior to Phase 4, bringing leakage down to  $\sim 0.5$  kg in the same time span.
- Joints will be tested per NASA-STD-7012 to verify that they are within the leak rates above.
- The system level leakage will also be calculated by taking the sum of all joint leakages after manufacturing, and will be confirmed to provide positive margin at the end of mission.

# Pressure/Temperature Data

[Back to main!](#)

- Pressure and temperature data will be taken using triplicated pressure transducers and resistance temperature detectors (RTD).
  - RTDs chosen over thermocouples for superior precision, at the cost of reduced responsiveness.
- Pressure and temperature data will be taken on the tanks, critical junctions of plumbing, and the thrusters.
  - Instead of taking temperature data on each of the secondary thrusters, temperature data will be taken on the mounting location of the thruster packs to allow better knowledge of the heat going into the system. This could alternatively be achieved by using thermopiles, at the cost of direct temperature measurement.

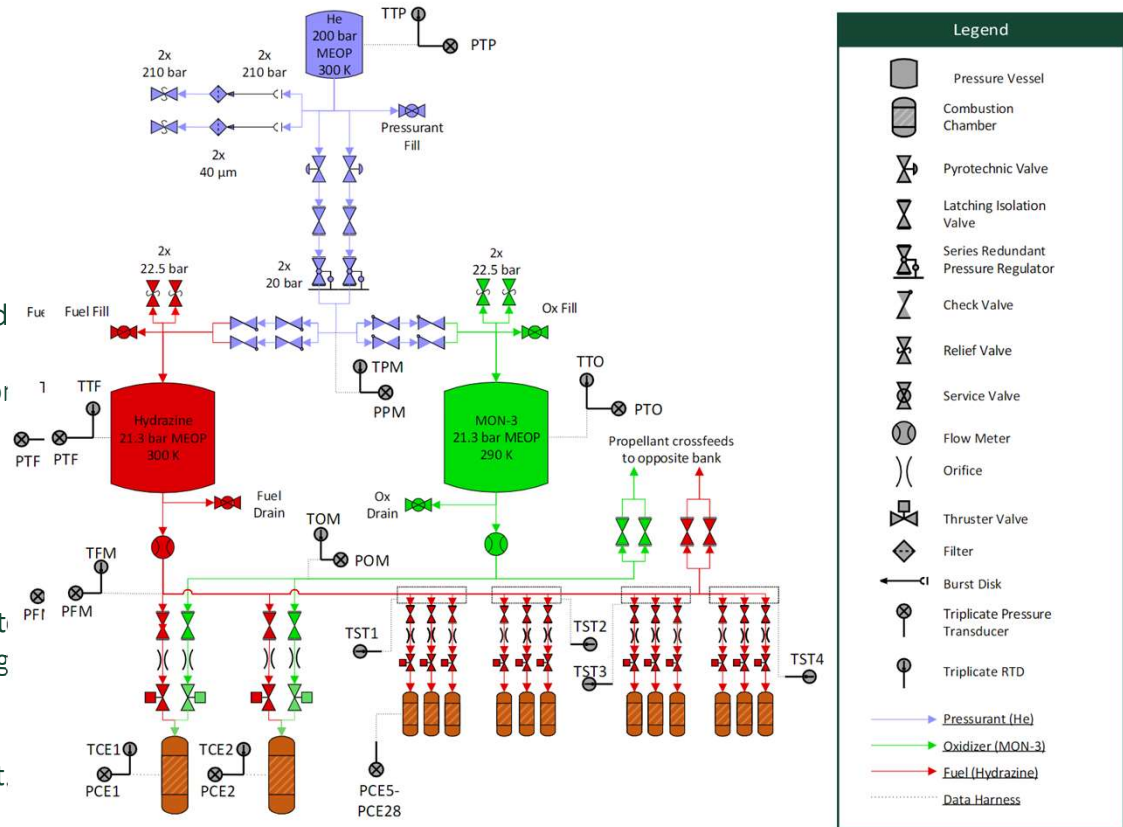

# Pressure/Temperature Data

- Data Channels will be named as
  - First letter: P/T for pressure/temperature
  - Next letters: Component designator
    - TO: Tank, Oxidizer
    - TF: Tank, Fuel
    - TP: Tank, Pressurant
    - OM: Oxidizer Manifold
    - FM: Fuel Manifold
    - PM: Pressurant manifold
    - CE: Chamber, Engine
    - ST: Secondary Thruster mounting plate
  - Numbers at the end designate multiples of components to help differentiate
  - Not shown at right, will be A/B/C following reference designators for triplicate-redundant sensors.
  - EX: PCE4B : Pressure, Chamber, Engine 4, Channel B

Reference Designator	Description	Data Rate [Hz]	MEOP/T [bar, K]	Driven by
PTO	Ox tank pressure	1000	22.5	PMO
PTF	Fuel Tank Pressure	1000	22.5	PMF
PTP	Pressurant Tank Pressure	1000	205	PTO/PTF after blowdown
POM	Ox manifold pressure	1000	21.5	PCPE
PFM	Fuel manifold pressure	1000	21.5	PCPE
PPM	Pressurant Manifold Pressure	1000	21.5	PTO/PTF
PCE1	Primary Engine 1 Pc	1000	9.4	Aerojet
PCE2	Primary Engine 2 Pc	1000	9.4	Aerojet
PCE3	Primary Engine 3 Pc	1000	9.4	Aerojet
PCE4	Primary Engine 4 Pc	1000	9.4	Aerojet
PCE5	Secondary Engine 1 Pc	1000	6.9	Aerojet
PCE6	Secondary Engine 2 Pc	1000	6.9	Aerojet
PCE7	Secondary Engine 3 Pc	1000	6.9	Aerojet
PCE8	Secondary Engine 4 Pc	1000	6.9	Aerojet
PCE9	Secondary Engine 5 Pc	1000	6.9	Aerojet
PCE10	Secondary Engine 6 Pc	1000	6.9	Aerojet
PCE11	Secondary Engine 7 Pc	1000	6.9	Aerojet
PCE12	Secondary Engine 8 Pc	1000	6.9	Aerojet
PCE13	Secondary Engine 9 Pc	1000	6.9	Aerojet
PCE14	Secondary Engine 10 Pc	1000	6.9	Aerojet
TTO	Ox tank temperature	10	290	Ox Boiling
TTF	Fuel tank temperature	10	300	~Ox boiling
TTP	Pressurant tank temperature	10	300	~Ox boiling
TOM	Ox manifold temperature	10	290	~Ox boiling
TFM	Fuel manifold temperature	10	300	~Ox boiling
TPM				
TCE1	Primary engine 1 Tc	10	3000	PE Tc
TCE2	Primary engine 2 Tc	10	3000	PE Tc
TCE3	Primary engine 3 Tc	10	3000	PE Tc
TCE4	Primary engine 4 Tc	10	3000	PE Tc
TST1	Thruster Plate 1 Temp	10	400	SE Flange temp
TST2	Thruster Plate 2 Temp	10	400	SE Flange temp
TST3	Thruster Plate 3 Temp	10	400	SE Flange temp
TST4	Thruster Plate 4 Temp	10	400	SE Flange temp

# Propellant Utilization (PU) Algorithm

[Back to main!](#)

A propellant utilization (PU) algorithm will be used to maximize the dV while the primary propulsion system is active. This will allow the vehicle to burn at lower or higher mixture ratios in order to guarantee that the spacecraft has a minimal dry mass. Thruster flow control valves on the primary propulsion engines can skew the MR from 0.70 - 1.33 and will be used to achieve bulk MR corrections. The PU algorithm has not been explicitly written, but a general control scheme can be seen below.

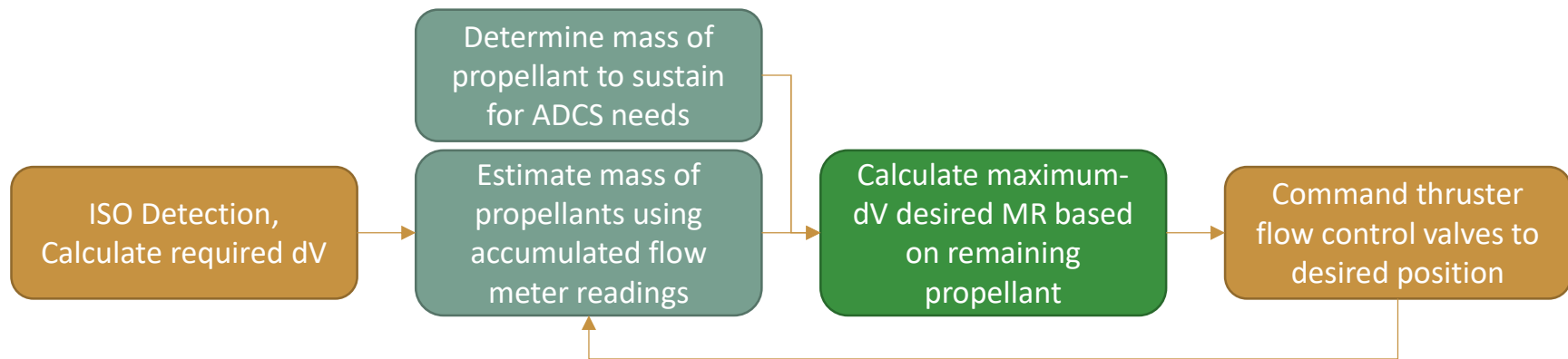

# Propulsion Team Risks

- Given that the propellant lines freeze there is a possibility of the necessity of using resistive heaters to keep the propellant lines with acceptable temperatures adversely impacting the propulsion plumbing system, which can result in the spacecraft leaking propellant.

Likelihood: 1  
Severity: 5

- Given that the gimbal mounting fails or there is degradation of the mounting component over time due to the environment there is a possibility of the components that utilize these mounts not deploying, adversely impacting the secondary thruster system and structural gimbal mounts, which can result in a reduction in attitude control effectiveness, and

increased difficulty or destruction, and a reduction of the translational speed control.

Likelihood: 1  
Severity: 3 or 4

- Given that the secondary thrusters go out there is a possibility of the propulsion of the spacecraft not being sufficient to complete the mission adversely impacting the secondary thruster systems and propulsion plumbing system, which can result in a reduction of attitude control effectiveness and a reduction in translational motion control.

Likelihood: 2  
Severity: 3 or 4

# Secondary Propulsion Thrusters

## MR-111G 4N (1.0 lbf) Rocket Engine Assembly



[Link](#)

Thrust: 4 N each

Isp: 219-229 s

Qty: 12 pairs, total quantity 24

Total propellant consumed: (760 kg Hydrazine)

Monopropellant chosen to provide simple secondary system. Thrust level semi-arbitrary based on ADCS unknowns, upsizing to higher thrust levels is still an option.

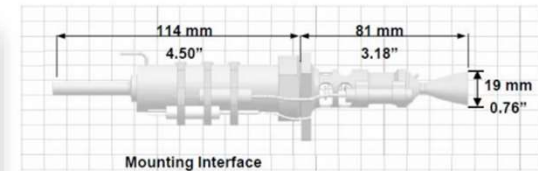

### Design Characteristics

- Propellant..... Hydrazine
- Catalyst..... S-405
- Thrust/Steady State..... 4.9 - 1.8 N (1.1 - 0.4 lbf)
- Feed Pressure..... 24.1 - 6.7 bar (350 - 100 psia)
- Chamber Pressure..... 10.0 - 3.7 bar (145 - 54 psia)
- Expansion Ratio..... 74:1
- Flow Rate..... 2.0 - 0.77 g/sec (0.0044 - 0.0017 lbm/sec)
- Valve..... Dual Seat
- Valve Power..... 8.25 Watts Max @ 28 Vdc & 21°C
- Valve Heater Power... 1.54 Watts Max @ 28 Vdc & 21°C
- Cat. Bed Heater Power...6.32 Watts Max @ 28 Vdc & 21°C
- Mass..... 0.37 kg (0.82 lbm)
  - Engine..... 0.11 kg (0.24 lbm)
  - Valve..... 0.20 kg (0.44 lbm)
  - Heaters.....0.065 kg (0.14 lbm)

### Performance

- Specific Impulse..... 229 - 219 sec (lbf-sec/lbm)
- Total Impulse..... 262,000 N-sec (59,000 lbf-sec)
- Total Pulses..... 420,000
- Min Impulse Bit..... 0.076 N-sec @ 15.5 bar & 20 ms ON
- .....(0.017 lbf-sec @ 225 psia & 20 ms ON)
- Steady State Firing..... 10,000 sec demonstrated - Single Firing

### Status

- Flight Proven
- Currently in Production

### Reference

- AIAA-2012-3817

11411 139th Place NE • Redmond, WA 98052  
(425) 885-5000 FAX (425) 882-5747



# High Pressure Regulator

[Link](#)

Capable of .003 lbm/sec GHe =1.35e-3 kg/s GHe  
 System requirement: 8.47e-4 kgs GHe

Helium Flow Rate during Primary Firing (assuming constant nominal thrust, ideal Isp)

Force	890	N		
Isp	329	s		
mdot prop	0.275756083	kg/s		
mdot (Ox/Fu)	0.137878041	0.137878041	kg/s	
Volumetric Flow Rate (Ox/Fu)	9.50883E-05	0.000135042	m3/s	
Mass Flow Rate (He)	3.43E-04	5.04E-04	kg/s	
	7.55E-04	2.29E-04	lbm/s	
Total Mass Flow Rate (He)		8.47E-04	kg/s	



HELIUM REGULATOR / SYSTEM FILTER  
 V1E10776-01

DESCRIPTION

VACCO Industries offers a compact, pre-integrated system filter and Helium regulator to precisely control the pressure to propellant feed systems. The series-redundant regulator is qualified for use in spacecraft and missile dynamic environments. Dynamic stability and contamination protection has been demonstrated under all operating conditions, including rapid application of inlet pressure from a pyrotechnic valve.

The series-redundant pressure regulators are completely protected from external contamination by filters in the inlet, outlet, and sensing ports. For added protection, there is a separate inlet filter for the redundant regulator.



FEATURES

- ◆ Combination System Filter and Regulator
- ◆ Series Redundant CRES Regulators
- ◆ Regulation Accuracy within ± 2.5%
- ◆ Inlet Pressure Range from 4500 to 400 psig
- ◆ Internal Leakage is less than 20 sccm
- ◆ Rapid Transient Recovery
- ◆ 25 Micron (absolute) Filtration
- ◆ Etched Disc Titanium Filters
- ◆ Clog-Proof Titanium Sensing Restrictor

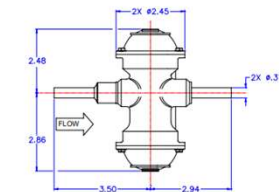

OPERATING PARAMETERS

Operating Pressure Range	4500 to 400 psig	External Leakage	1 x 10 <sup>-6</sup> sccm GH
Proof Pressure	6750 psig	Mass	< 2.30 lbm
Burst Pressure	11,250 psig	Operating Temperature	0° to 100° F
Flow	.003 lbm/sec GHe	Back Pressure Relief	.350 psid
Internal Leakage	< 20 sccm GHe	Filter Rating	25 micron

Performance characteristics are based upon customer requirements, as such, are not representative of component capabilities or limitations

# Low Pressure Relief Valve

[Link](#)



## LOW PRESSURE RELIEF VALVE V1D10879-01

### DESCRIPTION

VACCO Aerospace Products produces a relief valve for designed exclusively to satisfy the needs of the space industry.

A unique advantage of VACCO's relief valve is that the seat/seal configuration is flight qualified and has demonstrated successful flight heritage for over 10 years. The relief valve incorporates a teflon seat design used for low leakage over a wide range of temperatures.



### FEATURES

- ✦ Seat/Seal Configuration Flight Qualified
- ✦ All Welded External Construction
- ✦ Relief Pressure: 335 psid max.
- ✦ Reset Pressure: 280 psid min.
- ✦ Weight: .75 lbm (340 grams)
- ✦ Machined Body to Assure Structural Rigidity
- ✦ Optimized for High Flow Stable Operation

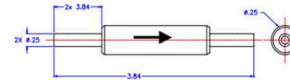

### OPERATING PARAMETERS

Operating Pressure Range .....	355 psid*	External Leakage .....	1 X 10 <sup>6</sup> sccs GHe***
Proof Pressure .....	650 psig	Internal Leakage .....	1 X 10 <sup>3</sup> sccs GHe****
Burst Pressure .....	1,300 psig	Operating Temperature .....	-170° to +45° C
Flow .....	100 scfm GHe**	Non-operating Temperature .....	-40° to +45° C
Pressure .....	335 psid max.	Weight .....	340 grams
Reset Pressure .....	280 psid min.	Shock .....	2000 G's
		Life .....	200 cycles

\*Note: Based on Actual Test Data

\*\*Note: Based on Actual Test Data, 100 scfm @ 355 psid

\*\*\*Note: External Leakage measured at 270 ± 5 psia for 5 minutes

\*\*\*\*Note: Internal Leakage measured from 0-280 psia

Performance characteristics are based upon customer requirements, as such, are not representative of component capabilities or limitations.

# High Pressure Latching Iso Valve

[Link](#)



**1/4" HIGH PRESSURE LATCH VALVE**  
V1E10763-01

**DESCRIPTION**

VACCO Industries maintains a product line of titanium latching valves designed to meet industry's demand for high reliability, tight leakage, and quick response capabilities.

The VACCO 5000 psi 1/4" latch valve utilizes proven torque tube technology. The all titanium construction helps reduce weight while bolstering reliability, qualified to a minimum 13,000 life cycles while maintaining performance. The valve is fully qualified and is scheduled for flight in 2002.



**FEATURES**

- ◆ 5,000 psig Operating Pressure
- ◆ 13,000 Operating Cycles
- ◆ Ti Body with CRES Interface
- ◆ Low Weight – 0.75 LB (340 Grams)
- ◆ Integral Microswitch
- ◆ 40 Micron Absolute Etched Disc Inlet Filter

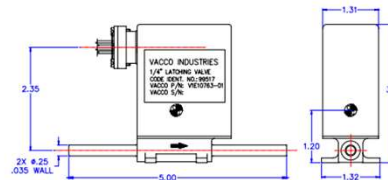

**OPERATING PARAMETERS**

Operating Pressure.....	5000 psig	Cycle Life.....	> 13,000 Cycle
Proof Pressure.....	7500 psig	Operating Temp.....	14 - 140°F
Burst Pressure.....	12,500 psig	Response Time.....	Opening:..... 20 msec @ 29 VDC @ 5000 psid
Flow/Pressure Drop.....	<10 psid @ 1.06		Closing:..... 20 msec @ 29 VDC, 5000 psid
Leakage:		Opening Voltage.....	24 - 32 VDC
Internal.....	< 5.0 scch GHe @ 5000 psid	Power Consumption ..	20 W max @ 29 VDC and 76°F
External.....	1x10 <sup>6</sup> scch GHe @ 5000 psid	Dielectric Strength .....	500 VAC RMS @ 60 Hz-1 min
Back Pressure Relief.....	1500 ± 500 psid		

# Low Pressure Latching Iso Valve

[Link](#)



LOW PRESSURE 1/4" LATCH VALVE  
V1E10405-04

**DESCRIPTION**

VACCO Industries maintains a product line of titanium latching valves designed to meet industry's demand for high reliability, tight leakage, and quick response capabilities.

The 1/4" low-pressure latch valve utilizes VACCO's proven torque tube technology. The all titanium construction helps reduce weight while bolstering reliability; qualified to a minimum 20,000 life cycles without deteriorating performance. The valve is fully flight-qualified and holds extensive heritage.

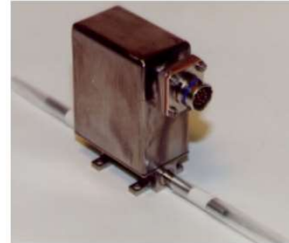

**FEATURES**

- ✦ 400 psi Operating Pressure
- ✦ Flight Qualified
- ✦ All Titanium Construction
- ✦ Low Weight – 340g/0.75 lbm
- ✦ Integral Microswitch
- ✦ Bi-Directional Flow
- ✦ 40μ Absolute Inlet Filter

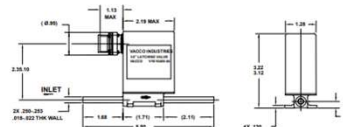

**OPERATING PARAMETERS**

Operating Pressure Range .....	400 psig	Operating Temperature .....	+30° to 150° F
Proof Pressure .....	900 psig	Response Time	
Burst Pressure .....	2400 psig	Opening .....	50 msec @ 20 VDC
Flow .....	0.025 lbm/sec H <sub>2</sub> O	Closing .....	50 msec @ 20 VDC
Pressure Drop .....	<15 psid	Back Pressure Relief .....	350 psid
Internal Leakage .....	<5.0 scch GHe	Inlet Filter Rating .....	40 microns absolute
External Leakage .....	<1 X 10 <sup>-5</sup> scch GHe	Operating Voltage .....	20 – 50 VDC
Weight .....	0.75 lbm (340 grams)	Dielectric Strength .....	500 VAC RMS @ 60 Hz – 1 min

# Low Pressure Check Valve

[Link](#)

Would need to get check valves manufactured to 1/4" (6.35 mm) tube instead of 3/8" tubes.



**3/8" LOW PRESSURE CHECK VALVE  
V1D10856-02**

**DESCRIPTION**

VACCO Industries maintains a product line of stainless and titanium check valves to meet industry's demand for high reliability and tight leakage.

The 3/8" check valve developed for the Mars Ascent program is a titanium welded unit capable of very low external leakage and wide range of temperature extremes (-170° to 45° C). The valve contains an angled-machined seating surface, different from the poppet sealing surface allowing an increase in seat stress. The increase in seat stress improves sealing capability of the valve. This type of design has been in used in other VACCO valves for many years.



**FEATURES**

- ✦ Temperature Range: -170° to 45° C
- ✦ Seat/Seal Configuration Flight Qualified
- ✦ All Welded External Construction
- ✦ Operating Pressure: 550 psia
- ✦ Weight: 20 grams
- ✦ 10 Years of Successful Flight Heritage
- ✦ 5,000 Poppet Cycles

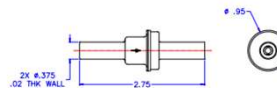

**OPERATING PARAMETERS**

Operating Pressure Range.....	550 psia	Reseat Pressure.....	1.0 psid
Proof Pressure.....	825 psia	External Leakage.....	<1 X 10 <sup>6</sup> sccs GHee
Burst Pressure.....	1,100 psia	Internal Leakage.....	100 sccs GHe @ 5 psid 0
Flow.....	.7 grams/second GHe	Operating Temperature.....	-170° to +45° C
Pressure Drop.....	.10 psid	Non-operating Temperature.....	-40° to +45° C
Cracking Pressure.....	.7.5 psid	Weight.....	.20 grams

[Back to main!](#)

# Pyrotechnic Valve

[Link](#)

Pyrovalve Key Technical Characteristics	
Initiators	Redundant ESA Standard Initiators
Design	All-welded Titanium design
Fluid Compability	Helium, Argon, Xenon, Nitrogen, MON, MMH, Hydrazine, Deionized Water, IPA
Response Time (Mechanical)	< 7ms
Mass	< 0.160 kg (depending on type)
Qualified Operating Temperature	-90°C ≤ T ≤ 100°C
Qualified Operating Pressure (MEOP)	310 bar
Proof Pressure	1.5 x MEOP (465 bar)
Burst Pressure (NO and NC)	
Pre firing	> 4x MEOP (rupture pressure: > 1240 bar)
Post firing	> 2.5x MEOP (rupture pressure: > 775 bar)
Leakage	
Normally Open	Internal leak after firing: < 1x10 <sup>-6</sup> scc/s (GHe) External leak before/after firing: < 1x10 <sup>-6</sup> scc/s (GHe)
Normally Closed	Internal leak before firing: < 1x10 <sup>-6</sup> scc/s (GHe) External leak before/after firing: < 1x10 <sup>-6</sup> scc/s (GHe)



# Primary Propulsion Engine

## R-4D-15 HiPAT™ 445 N (100 lbf) Dual Mode High Performance Rocket Engine



[Link](#)

Thrust: 445 N each

Isp: 329 s @  $\epsilon = 375$

Qty: 4 total

Total propellant consumed: 10816 kg  
(5408 kg MON-3, 5408 kg Hydrazine)

Chosen due to highest Isp, reasonable thrust, and capability to use Hydrazine for monopropellant secondary.

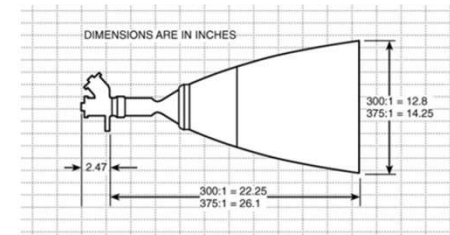

### Design Characteristics

- Propellant . . . . .Hydrazine/NTO (MON-3)
- Nominal Thrust (steady state) . . . . . 445 N (100 lbf)
- Thrust Range (steady state) . . . . . 329 – 556 N (70-125 lbf)
- Chamber Pressure\* . . . . .9.4 bar (137 psia)
- Inlet Pressure\* . . . . . >16.2 bar (235 psia)
- Inlet Pressure Range . . . . . 21.4 – 15.2 bar (310 – 220 psia)
- Valve . . . . .Aerojet Rocketdyne, Dual Coil, Single Seat
- Expansion Ratio . . . . . 300:1 or 375:1
- Nominal Mixture Ratio (O/F) . . . . . 1.0
- Mixture Ratio Range (O/F) . . . . . 0.70 – 1.33
- Mass . . . . . 300:1= 5.2 kg (11.5 lbf), 375:1 = 5.44 kg (12.0 lbf)

### Performance

- Specific Impulse @ 70°F and MR = 1.0 . . . . . 300:1 = 326 sec, 375:1 = 329 sec
- Total Impulse Qualified . . . . . > 9.55 X 10<sup>6</sup> N-sec (2.15 X 10<sup>6</sup> lbf-sec)
- Minimum Impulse Bit . . . . . 35.6 N-s (8 lbf-s)
- Demonstrated Steady State Firing Duration . . . . . 1,800 sec
- Total Number of Pulses Qualified . . . . . 672 starts
- . . . . . 345 thermal cycles

### Status

- Qualified
- Currently in Production

### References

- AIAA-2003-4775

\* At nominal Thrust

11411 139th Place NE • Redmond, WA 98052  
(425) 885-5000 FAX (425) 882-5747

---

# Payload

---

Speaker:



Move to Backup

# Operational Timeline - Payload

## Payload Operation Timelines

- At 4000 km inbound approach pick off mirror will be directing light to IR sensor
- At 2000 km inbound approach pick off mirror will switch to direct light to visual sensor
- At 800 km inbound approach SAR system will begin to collect data
- At 800 km outbound approach SAR will end data collection
- At 2000 km outbound approach pick off mirror will switch back to IR sensor
- Primary science collection will be finished at 4000 km outbound approach

# SAR Model Verification

Inputs:

SAR Parameter	Look Angle	SC Height	Bandwidth	Central Frequency	Antenna Size
ERS-1	23 deg	785 km	15.55 MHz	5.3 GHz	10m x 1m

Comparing Outputs vs Actual Performance:

SAR Performance	Model	ERS-1
Cross-track Footprint	96.5 km	100 km
Cross-track Resolution	24.7 m	26.3 m
Slant Range Resolution	9.64 m	10 m

[Back to Design Specifications-SAR](#)

---

# Payload Risks

- Given that the imager isn't aligned properly there is a possibility of a need to abandon primary and secondary sciences on one of the spacecraft adversely impacting the payload and primary and secondary science subsystems, which can result in an ability to only complete half of the required primary and secondary science data, limiting us to only using one spacecraft to rendezvous with the ISO

---

GNC

---

Speaker:

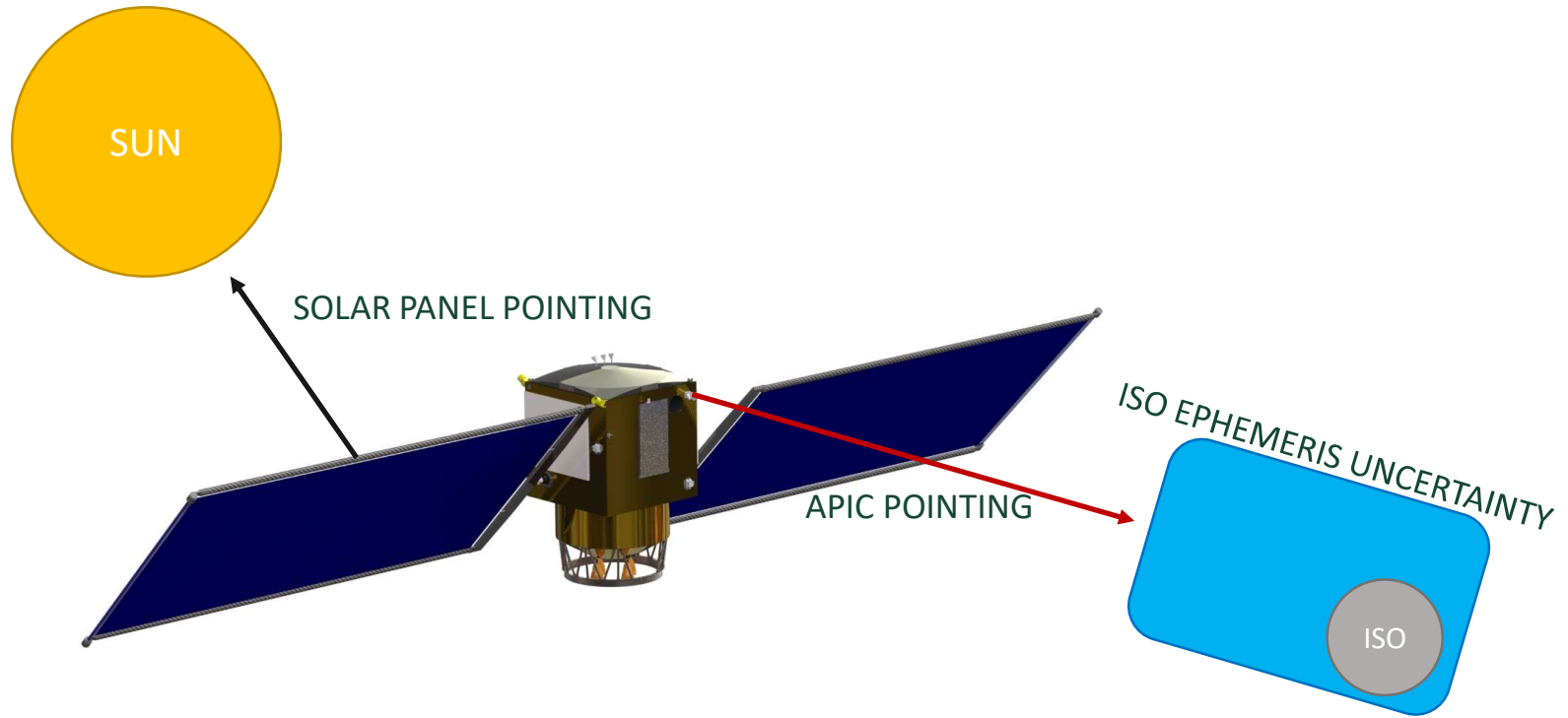

# Phase 5: ISO Flyby

## *Applicable Level 3 GNC Requirements*

ID	Requirement	Parent Requirement
GNC7	The GNC system shall be capable of optically navigating to the ISO autonomously.	
GNC8	The GNC system shall calculate the relative position between the flight system and the ISO +/- TBD km within a distance of TBD km from the ISO.	
GNC9	The GNC system calculate the relative velocity between the flight system and the ISO +/- TBD km/s within a distance of TBD km from the ISO.	
GNC12	The GNC system shall propagate the position of ISO with an accuracy of +/- TBD km throughout autonomous operations.	
GNC13	The GNC system shall propagate the velocity of the ISO with an accuracy of +/- TBD km/s throughout autonomous operations.	

# Navigation Model

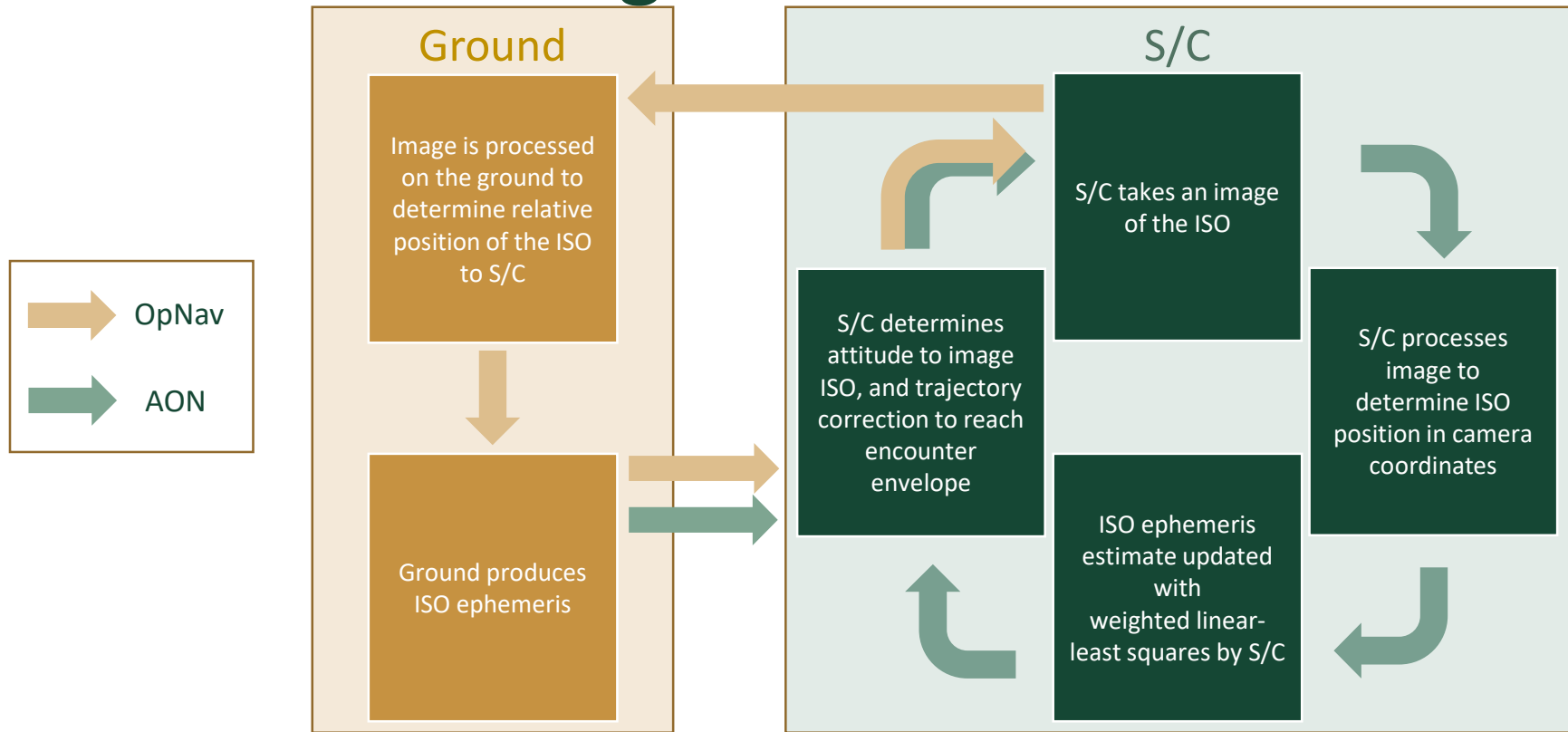

# Image Processing Methods

Iso  $\leq$  10 Pixels

- Analytics Function Fitting

Iso  $>$  10 Pixels

- Threshold Segmentation
- Edge Detection
- Ellipse Approximation via least squares

**Input**

Image of the ISO taken by the Spacecraft

**Output**

ISO center in Pixel Coordinates



# Image Processing Model



Base Image

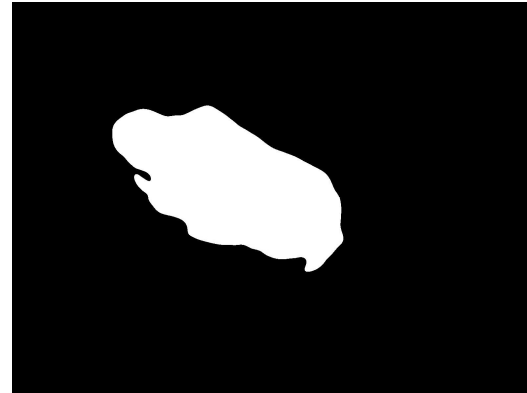

Threshold Segmentation

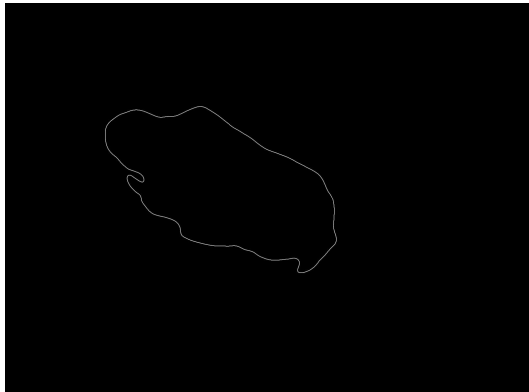

Edge Detection

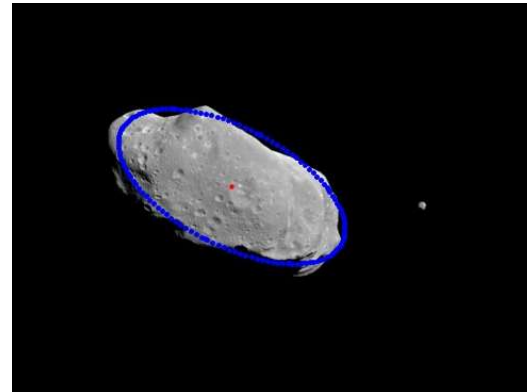

Ellipse Approximation with Center

---

# GNC Risks

- Given that the ISO shape and shadow can affect ephemeris updating of the autoNav system leading to false knowledge of the ISO position there is a possibility of an inability to properly image the ISO since we will be at a different range than expected adversely impacting the payload components, which can result in an inability to acquire images and science information from the ISO.

Severity: 1 or 2

Likelihood: 3

---

# Thermal

---

Speaker:

Speaker:

Speaker:

Speaker:

Speaker:

# Thermal Models – SolidWorks

## Overview

- Simplified geometry
- Steady-state thermal studies within SolidWorks
- Multiple scenarios studied varying different parameters

## Outcomes

- Verify behavior of combined system
- Provide recommendations for component placement, mounting, and surface finishes

## Inputs

- Geometry
- Material and surface properties
- Component contact resistance
- Mission scenarios
  - Component heat loads
  - Environmental heating
  - Louver and heater settings

## Outputs

- Temperature distribution
- Heat flux through different surfaces

# Thermal Models – SolidWorks

Scenario Name	Tank Fill	Component Activity	Pointing Orientation	Distance from Sun	Engine Activity
1AU Standard	Full	On	Earth	1 AU	Off
5AU Standard	Full	On	Earth	5 AU	Off
1AU Everything Off	Full	Off	Earth	1 AU	Off
5AU Everything Off	Full	Off	Earth	5 AU	Off
1AU Everything On	Full	On	Earth	1 AU	On
5AU Everything On	Full	On	Earth	5 AU	On
5AU No Prop	Empty	Off	Earth	5 AU	Off
Phase 4 -OpNav	Full	Phase 4.7	Earth	5 AU	On
Phase 7 - EOL	Full	Phase 7.1	Earth	5 AU+	On
Emergency 1	Half	Off	Sun	1 AU	On
Emergency 2	Empty	Off	Sun	5 AU	On

# Thermal Models – SolidWorks

Scenario Name	Temperatures (Deg C)			Louver Value (Effective $\epsilon$ )	Heater Value (W)	Notes and Issues
	Max	Min	Baseplate			
1AU Standard	78	-67	-3	0.3	150	Too cold, excess heat leak
5AU Standard	65	-80	-20	0.3	150	Too cold, excess heat leak
1AU Everything Off	65	-124	-83	0.1	N/A	Too cold, expected
5AU Everything Off	-120	-205	-187	0.1	N/A	Too cold, expected
1AU Everything On	N/A	-68	-6	0.3	50	Engines highly insulated
5AU Everything On	N/A	-71	-9	0.3	100	Engines highly insulated
5AU No Prop	-120	-205	-187	0.1	N/A	See 5 AU Everything Off
Phase 4 -OpNav	N/A	-71	-9	0.3	100	See 5 AU Everything On
Phase 7 - EOL	N/A	-71	-9	0.3	100	See 5 AU Everything On
Emergency 1	76	-64	2	0.3	250	Too cold, excess heat leak
Emergency 2	76	-64	2	0.3	250	Too cold, excess heat leak

# Thermal Models - SolidWorks

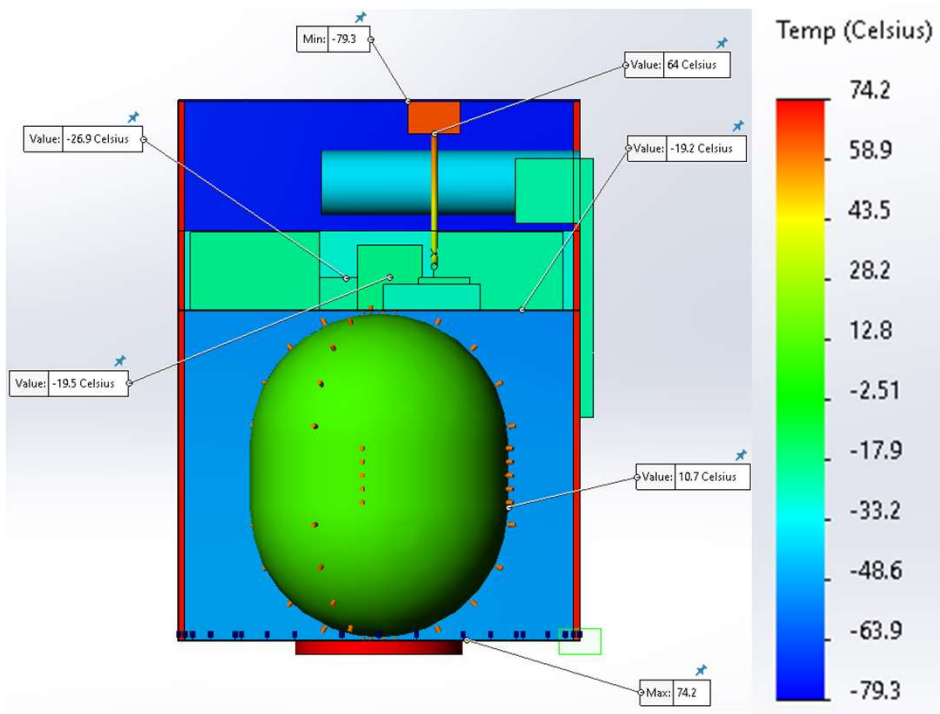

1 AU – Components on, Engines off

- Baseplate ties all components together, keeps them within 5 degrees of same temperature
- Future work: give each component specialized conduction to radiator using heat pipes
- Outer MLI exposed to sun has highest temperatures, not exposed has lowest. Neither significantly affect nearby components
- Internal radiation causes heating to telescope as well as heat leak not via radiator

# Thermal Models – SolidWorks

## Assumptions

- Geometry is close enough to provide +/- 20 deg accuracy
- Radiation between internal components
- External panels approximate MLI via material and surface properties
- All components operate with constant power use and waste heat generation
- Solar heating modeled by applying internal heat load to inside of MLI sheets

## Takeaways

- Heater balance – Power positive until later phases. Can run heaters as needed for most of mission, but need enough insulation for final phases
- Heat Leak – more heat than anticipated currently leaking from spacecraft, need proper insulation for thermal system to behave as intended
- Conductance – high conductance heat paths reduce component temperatures excessively, more design needed to correctly control temperature differentials



# Thermal Radiator Sizing

- Total Area = 4 m<sup>2</sup>
- Target Heat Rejection = 356 W
- Target Temperature = -20 °C
- Louver Control  
Effective emissivity range: 0.2- 0.7
- 180 – 650 W range at -20 °C

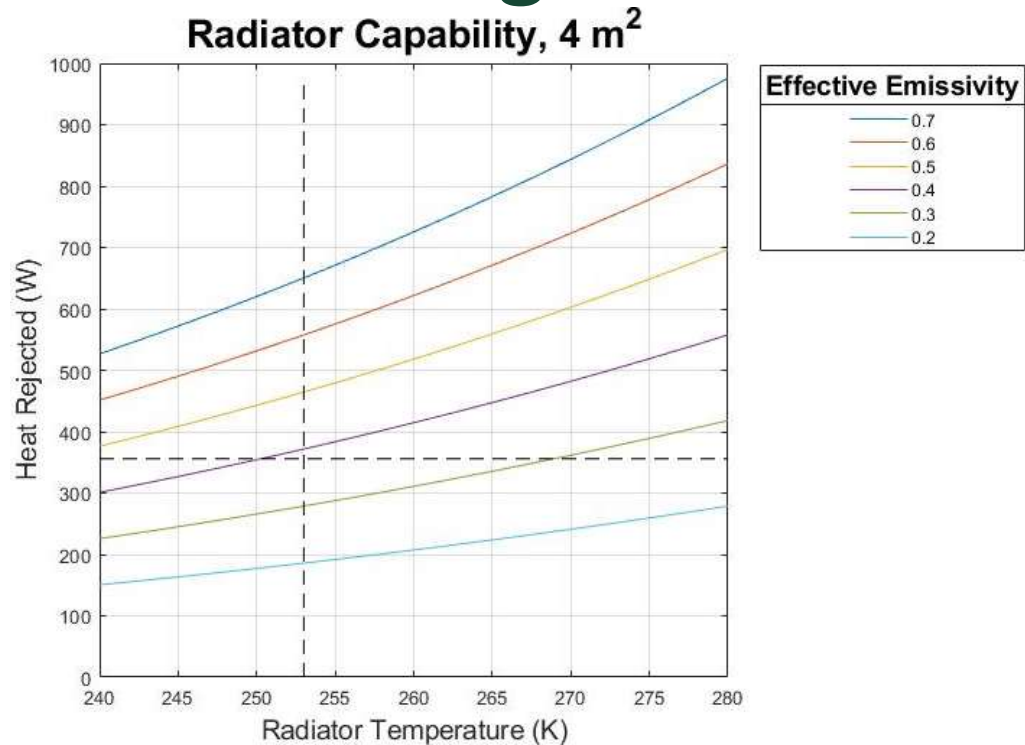

Possible heat rejection of 4m<sup>2</sup> Radiators  
Dashed lines are target values

# Thermal Heat Pipe Design and Sizing

- Aluminum was chosen for the main heat pipe material as it has a high heat transfer coefficient and a low density compared to other heat pipe material options considered (Copper and Stainless 316).
- Ammonia was chosen as the operating fluid, as the temperature ranges of ammonia best fit the operating temperature ranges and thermal conductivity that our system components required.
- A grooved aluminum pipe was chosen for the wick design, as it would accomplish the desired capillary action based on our orbital parameters and thermal requirements for ammonia as a working fluid.

Pipe Materials	Pipe Wall Thickness	Pipe Diameter	Pipe Length Estimate	Ammonia and Mercury Mass Estimates	Heat Pipe Total Mass Estimate
Aluminum	0.00089m	0.008m	11.5m < L < 34.5m	2-4kg of Ammonia	90kg – 270kg

# MLI Spoth heating Risk

Given that	There is a possibility of	Adversely impacting	Which can result in	Likelihood (out of 5)	Severity (out of 5)	Sub team
There is spot heating on the MLI blankets	An unintended reduction in MLI performance leading to excess heat loads or cooling of the spacecraft	The thermal system	The degradation of MLI which will reduce the ability of the thermal system to operate correctly for the entire mission	3	4	Thermal

# Loss of Control Risk

Given that	There is a possibility of	Adversely impacting	Which can result in	Likelihood (out of 5)	Severity (out of 5)	Sub team
There are vibrations of launch and the 20-year operation length	The components tied to the thermal system losing necessary control	The thermal system	A hinderance in overall performance of the thermal system, potentially up of loss of the spacecraft	3	2	Thermal

# Thermal Team Risks Continued

Given that	There is a possibility of	Adversely impacting	Which can result in	Likelihood (out of 5)	Severity (out of 5)	Sub team
The temperature sensors fail and that the team does not currently know a way to calibrate a temperature sensor in space	Component damage due to improper thermal management	The proper management and reliability of any component on the spacecraft where temperature knowledge is lost	The reduction of longevity, especially of the electronics	2	2	Thermal

# Thermal Team Risks Continued

Given that	There is a possibility of	Adversely impacting	Which can result in	Likelihood (out of 5)	Severity (out of 5)	Sub team
Thermal models cannot 100% match real world conditions or represent every interaction within the spacecraft	The expected behavior not being fully achieved leading to incorrect control	The thermal system	Out of bounds temperatures of some components	2	3	Thermal

# Thermal Team Risks Continued

Given that	There is a possibility of	Adversely impacting	Which can result in	Likelihood (out of 5)	Severity (out of 5)	Sub team
Steady state conditions are much easier to analyze, plan for, and model	Unforeseeable dynamic situations not being modeled or analyzed beforehand	The startup of electronic components as thermal control may lag	Issues quickly adapting to changes in the environment or spacecraft state meaning some timelines may not be executed as desired			Thermal

---

# Thermal Team Risks Continued

Given that	There is a possibility of	Adversely impacting	Which can result in	Likelihood (out of 5)	Severity (out of 5)	Sub team
There is inadequate heat power	The heaters failing to keep components warm, particularly the propulsion tanks	The propulsion fuel	The propulsion failing during navigation to the ISO	2	3	Thermal



# Thermal Team Risks Continued

Given that	There is a possibility of	Adversely impacting	Which can result in	Likelihood (out of 5)	Severity (out of 5)	Sub team
There is unanticipated degradation of the radiators	The radiators emitting less waste heat than necessary to maintain nominal onboard temperatures	The power system and any power consuming systems	The reduced performance of the thermal system	2	3	Thermal

# Thermal Team Risks Continued

Given that	There is a possibility of	Adversely impacting	Which can result in	Likelihood (out of 5)	Severity (out of 5)	Sub team
There is external heat load coming into the spacecraft due to solar irradiation, albedo from Earth, and albedo from the ISO	The radiators not being sized to emit enough waste heat from the spacecraft	The entire thermal management procedures	The spacecraft heating up more than anticipated and thermal control no longer being able to maintain temperature ranges	2	2	Thermal

# Phase 6 – Support Bus Downlink

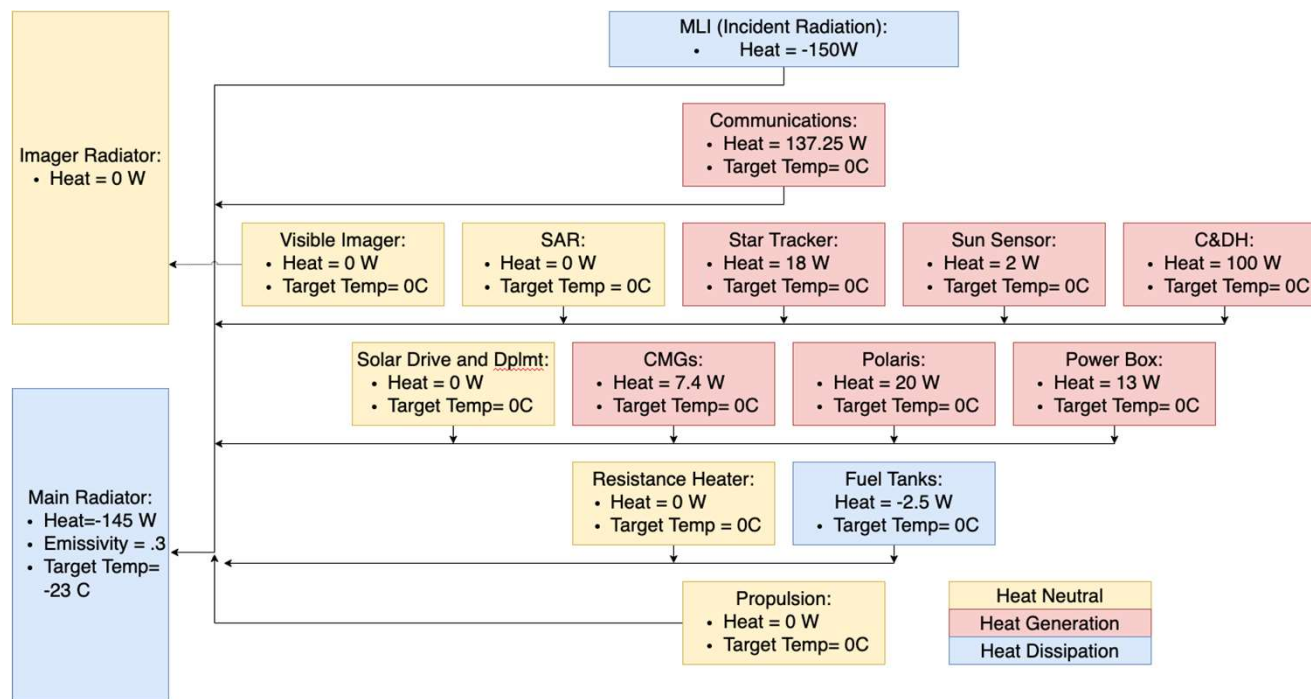

---

# Ground System

---

Speaker:

# Ground System/Spacecraft Geometry

- ISO entry case

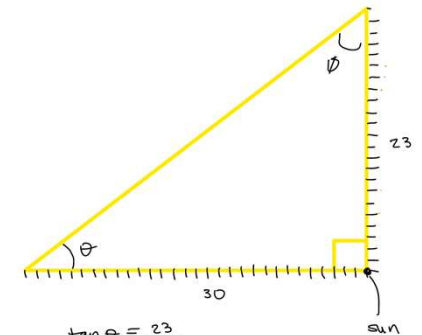
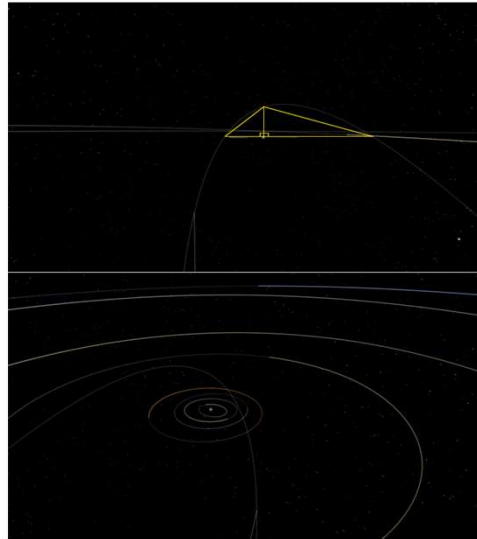
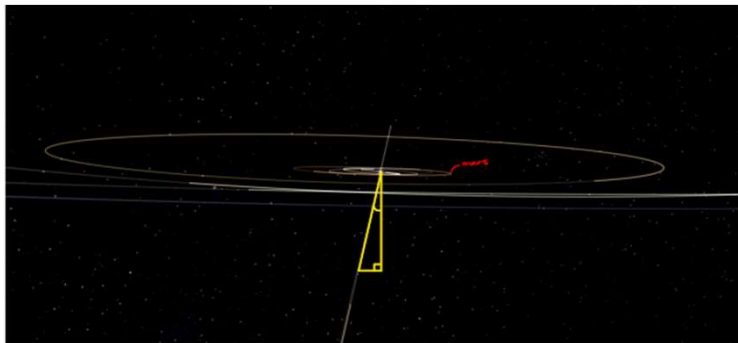

$$\tan \theta = \frac{23}{30}$$

$$\theta = 37.476^\circ$$

$$\phi = 90 - \theta$$

$$\phi = 52.524$$

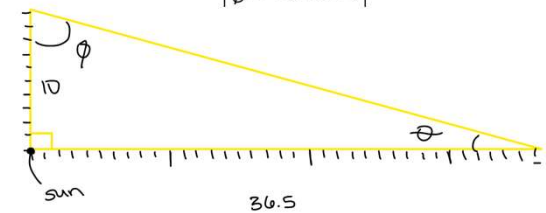

$$\tan \theta = \frac{10}{36.5}$$

$$\theta = 15.3215^\circ$$

$$\phi = 90 - \theta$$

$$\phi = 74.678^\circ$$

---

# Ground System Risks

- Given that there are unknowns about the ISO's trajectory there is a possibility of only being able to contact the spacecraft irregularly during mission critical times adversely impacting the mission control's ability to communicate with the spacecraft, which can result in uncertain orbits and GNC knowledge.

Likelihood: 4

Severity: decreases over time

# Mission Operations and Facilities

Speaker: Alexi or Berenice

# COSMIC Operation Centers – move to backup

ID	GS Facility	Rationale	GS Operation
MP3:8 MS1:4	Science Operation Center	Processes and meets all primary and secondary science-based objectives	
MP1,2 MP9	Mission Control Center	Processes and meets all command, navigation, and monitoring based requirements	
MP10	Network and Data Storage	Supports all operations of the Science and Mission Centers	
MP10	NASA DSN	Contracted Element for spacecraft contact	



# Operation Centers Interfaces

ID	Requirement	Rationale	GS Facility	Number of Personnel Assignment Per Spacecraft (x2)
G2, MP2, G26 G27, G28	Orbit design and control	Orbit/trajectory related station keeping, ISO departure determination and command design, and ISO encounter trajectory management	Mission Control Center	3 (ex: ephemeris management)
MP3, MP4, MP5 MP6, MP7, MP8 G25	Science processing	Received science packages must be unloaded to determine progress towards goals	Science Operations Center	2 (ex: dielectric, rotation, dimension)
MS2, MS3, MS4	Science command design	Science teams will want to point at celestial objects which competes with solar and station keeping pointing	Science Operations Center	4 (ex: exoplanet, sky coverage)
G3	Station keeping, subsystem health monitoring, response and command design	ADCS, propulsion, power keeping demands for pointing, thermal management, C&DH updates or patches	Mission Control Center	+4 (fuel management, trajectory upkeep, subsystem liaisons)
G20, G21, G22 G24,	Mission command packaging	The last step before COSMIC commands are sent to the DSN for flight system uplink	Mission Control Center	2



---

# ADCS

---

# Pointing Capability Model

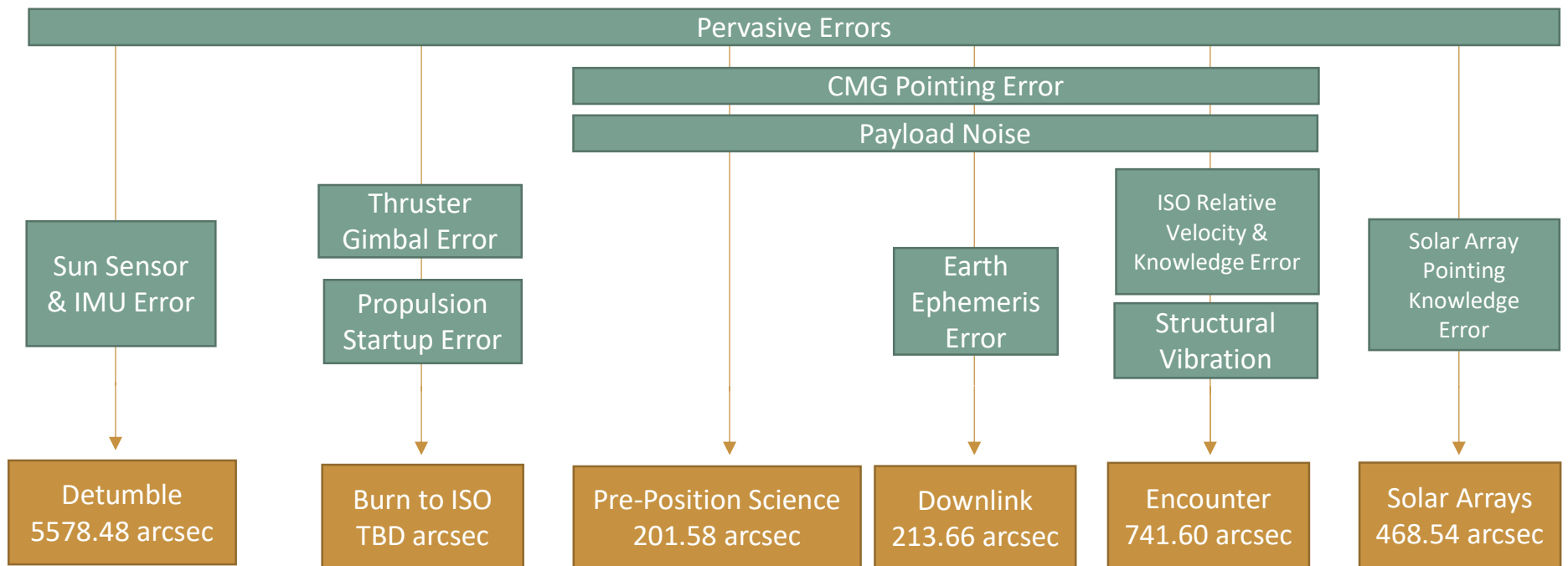

# Preposition Science Pointing Budget

Accuracy Error Description	3 $\sigma$ Error [arcsec]
CMG Pointing Error During Quasi-Static	20.626
Sensor Misalignment	0.017
Payload Misalignment	0.017
Star Tracker Misalignment	0.017
Star Tracker Noise	21.000
Thermal Deviations	135.520
Star Tracker Error	11.100
<b>Per Axis Total</b>	<b>188.296</b>

Stability Error Description	3 $\sigma$ Error [arcsec / s]
MED Vibration	0.5
Propellant Sloshing	10.31324031
<b>Total</b>	<b>10.81324031</b>

# Downlink Pointing Budget

Accuracy Error Description	3 $\sigma$ Error [arcsec]
CMG Pointing Error During Quasi-Static	20.626
Sensor Misalignment	0.017
Payload Misalignment	0.017
Star Tracker Misalignment	0.017
Star Tracker Noise	21.000
Thermal Deviations	135.520
Star Tracker Error	11.100
<b>Per Axis Total</b>	<b>188.296</b>

# Encounter Pointing Budget

Accuracy Error Description	3 $\sigma$ Error [arcsec]	Stability Error Description	3 $\sigma$ Error [arcsec / s]
CMG Pointing Error During Large Maneuver	412.530	MED Vibration	0.500
Sensor Misalignment	0.017	Propellant Sloshing	10.313
Payload Misalignment	0.017	Structural Vibration During Large Maneuver	0.003
Star Tracker Misalignment	0.017	APIC Measurement Error	1.974
Star Tracker Noise	21.000	<b>Total</b>	<b>12.790</b>
Thermal Deviations	135.520		
Star Tracker Error	11.100		
<b>Per Axis Total</b>	<b>580.199</b>		

# Solar Array Pointing Budget

Accuracy Error Description	3 $\sigma$ Error [arcsec]
CMG Pointing Error During Quasi-Static	20.626
Antenna Misalignment	0.017
Payload Misalignment	0.017
Star Tracker Misalignment	0.017
Star Tracker Noise	21.000
Thermal Deviations	135.520
Star Tracker Error	11.100
Solar Array Drive Pointing Knowledge error	72
Per Axis Total	260.296

# CMG Wheel Torques/ Gimbal Angles (return)

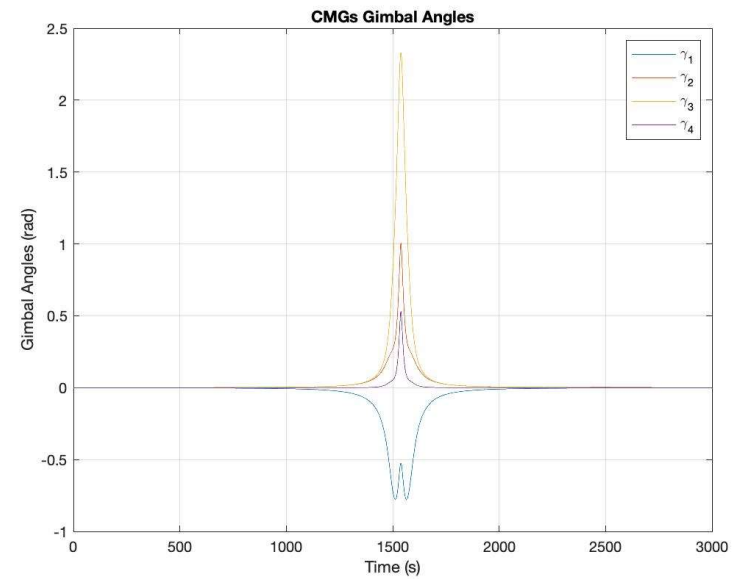
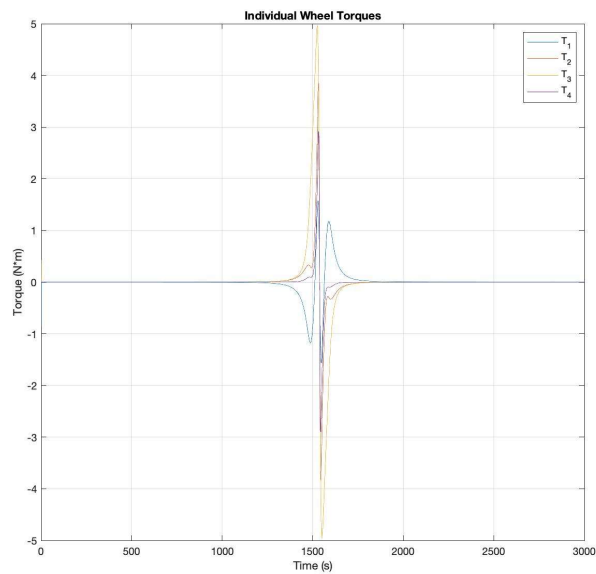



# CMG Preposition Desaturation due to Disturbance Torques

- Solar Radiation Pressure is the highest magnitude disturbance torque acting on the spacecraft during the prepositioned phase
- Attitude of spacecraft will point high gain antenna at Earth during most of phase, Solar Panels will have ~ 80-degree inclination to sun vector.
  - Near constant torque and accumulation of momentum
- **Torque values over time:** 0.1336 - 0.1430 Nm
- **Desaturation Timeline with 48 Nms of Momentum Storage:** 93.24 - 99.5 hours
- Desaturation will be performed by calculating the angular impulse vector required and using the secondary thrusters to achieve necessary impulse.
- Required mass of 76 kg for 20-year mission period

---

# ADCS Risks

- Given that the MEDs fail over the long mission life there is a possibility of an inability to perform the slew for encounter adversely impacting the resolution and our ability to find the ISO, which can result in an inability to achieve objectives.

---

# Comms

---

# Communication – Downlink Budget Supporting Values

Antenna	Supplier	Boresight Gain [dBi]	3dB Beamwidth [deg]	Centering Frequency [GHz]	Max Pointing Error [deg]	Required BER (u/d)	Modulation Scheme	Coding	Required Eb/N0 [dB]	Nominal Link Margin [dB]
HGA [Ka / X]	In House	57.88 / 44.81	0.217 / 0.979	32.2 / 7.153	0.1	1e-6	Direct BPSK	Turbo (R=½, l=5)	1.25	3
MGA	JPL	18.8	20	7.153	0.1	1e-6	Direct BPSK	Turbo (R=½, l=5)	1.25	3
LGA	JPL	7.7	80	7.153	0.1	1e-6	Direct BPSK	Turbo (R=½, l=5)	1.25	3

[RETURN TO 138](#)

[Backup](#)

# Telecom – Block Diagram

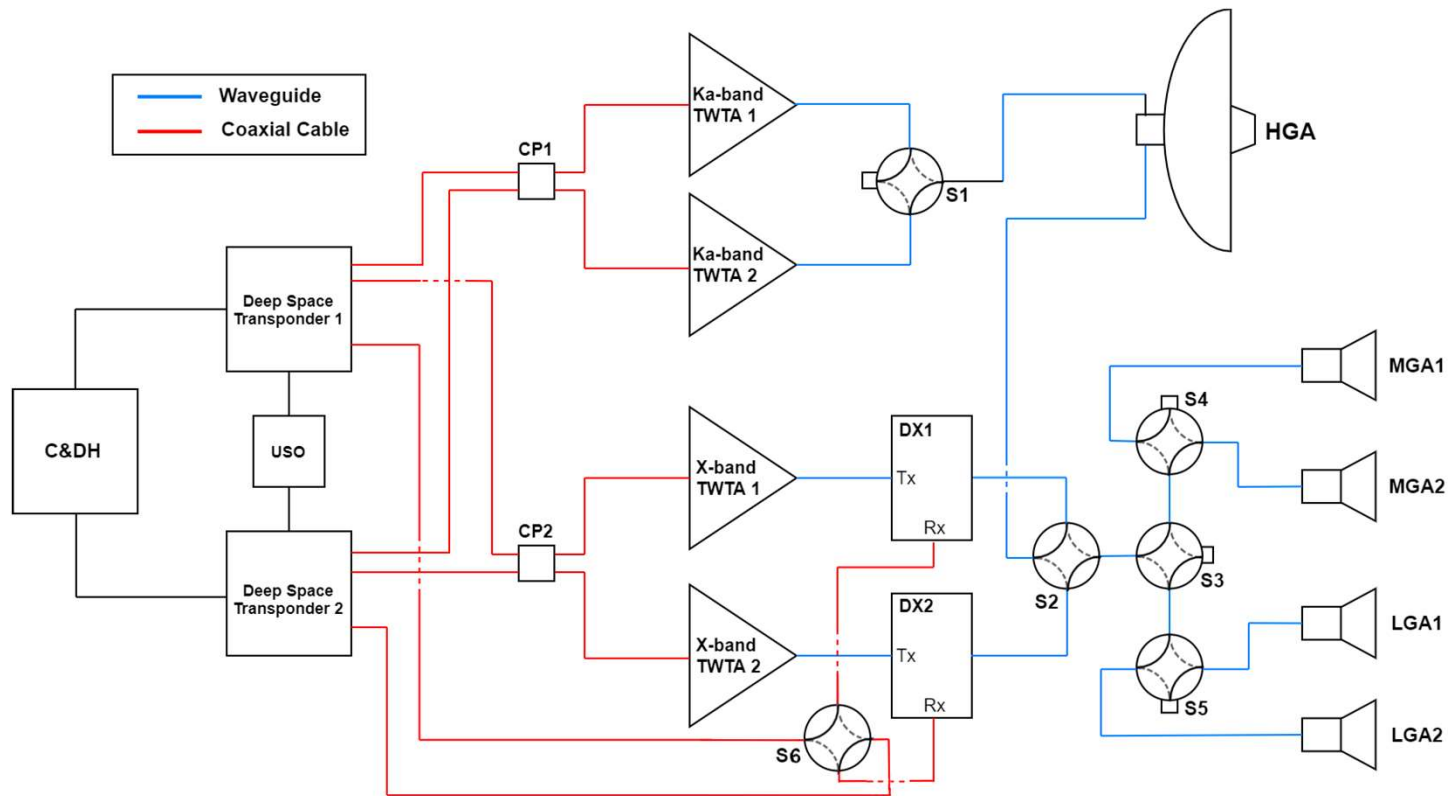

# Safe Mode Diagrams

Near Side Functional Ranges (Earth-S/c distance  $\leq$  Sun-S/c distance)

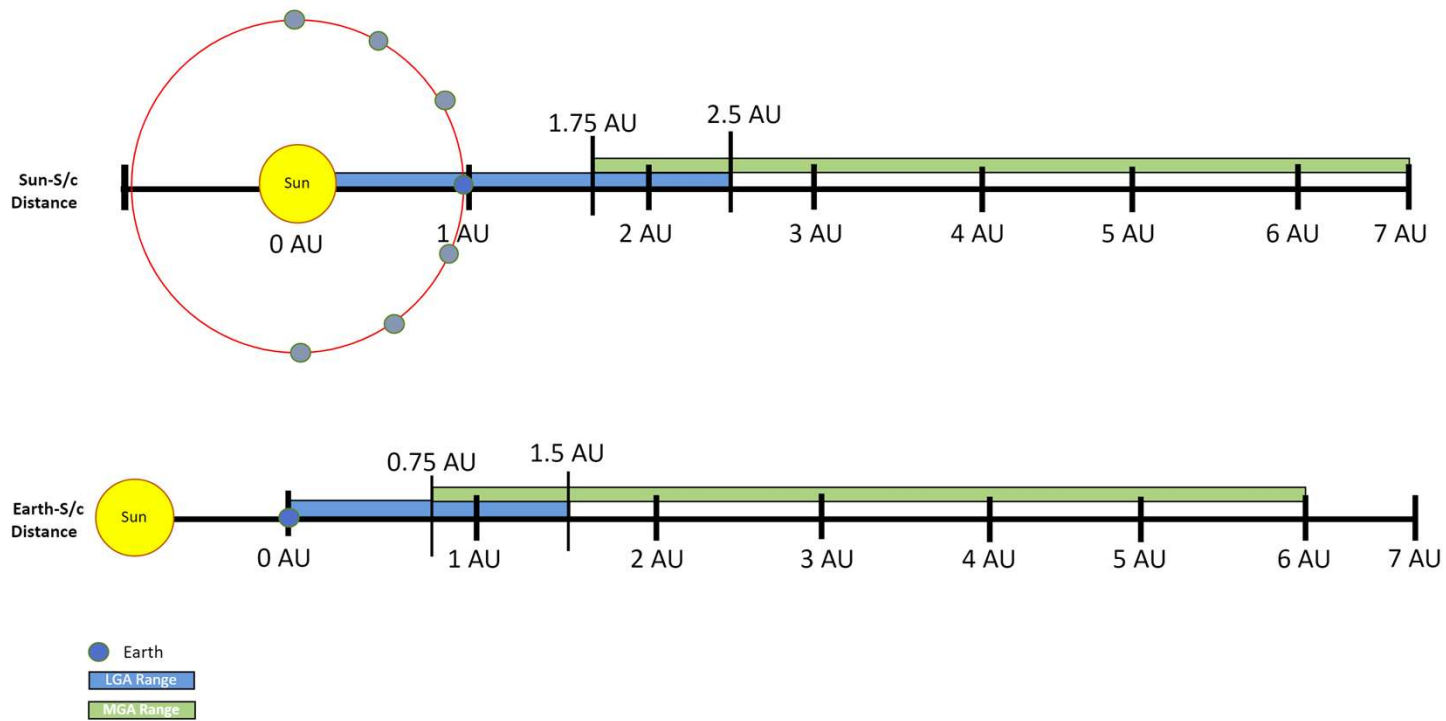

Detumble

# Safe Mode Diagrams

Far Side Functional Ranges (Earth-S/c distance  $\geq$  Sun- S/c distance)

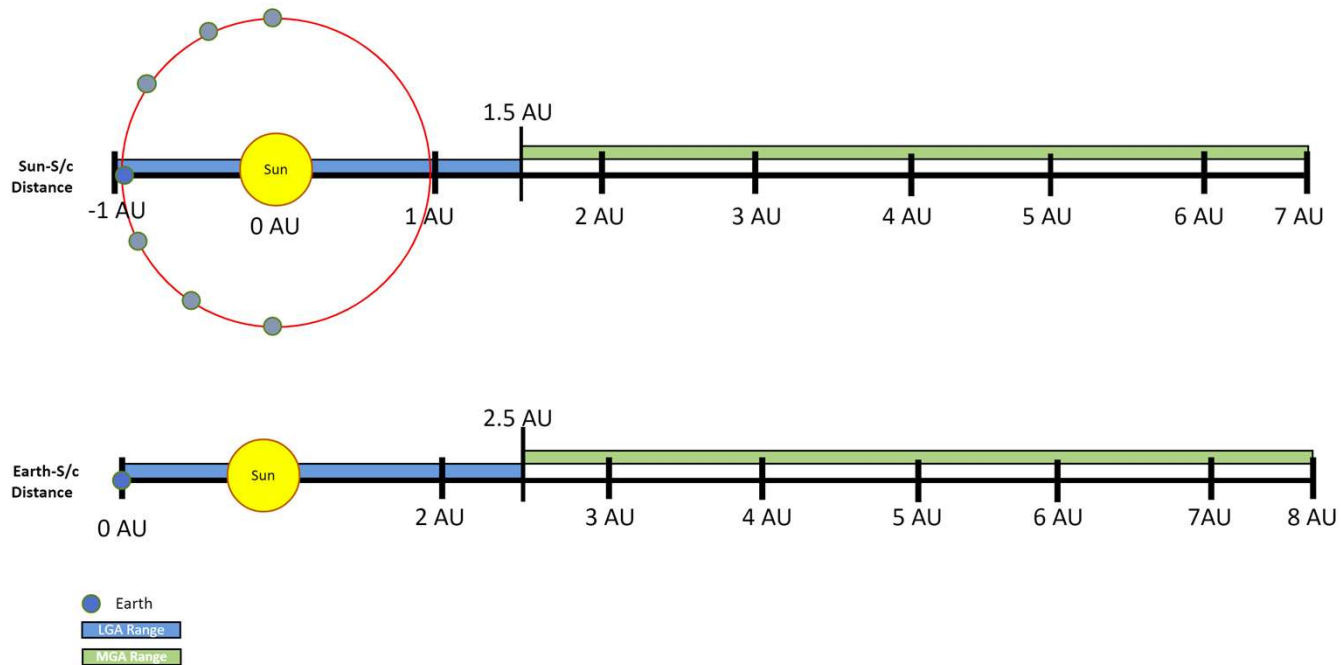

# Safe Mode Diagrams

Far Side Functional Ranges (Earth-S/c distance  $\geq$  Sun- S/c distance)

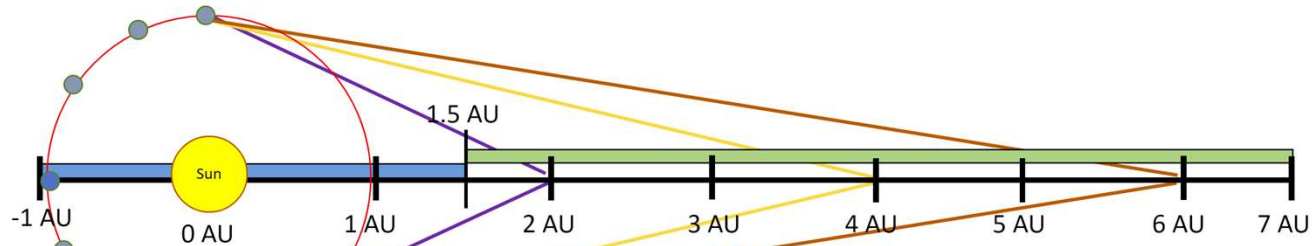

FOV Required				
Sun-S/c Distance	Near Side FOV (deg)		Far Side FOV (deg)	
2 AU	60		53	
4 AU	28.96		28.07	
6 AU	19.19		18.92	

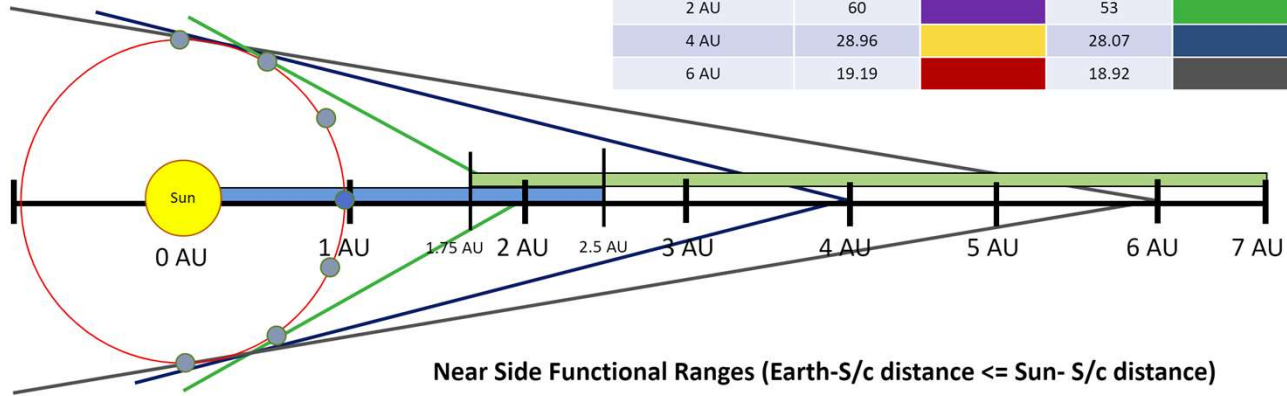

Near Side Functional Ranges (Earth-S/c distance  $\leq$  Sun- S/c distance)



# Safe Mode Diagrams

With s/c rotating at 3 deg/min  
minimum communication  
period with Earth every 2 hours

## Using LGAs

- PP: 26 min
- 1AU: 13 min

## Using MGAs

- 2AU: 10 min
- 4AU: 20 min
- 7AU: 44 min

\*Earth relative distance

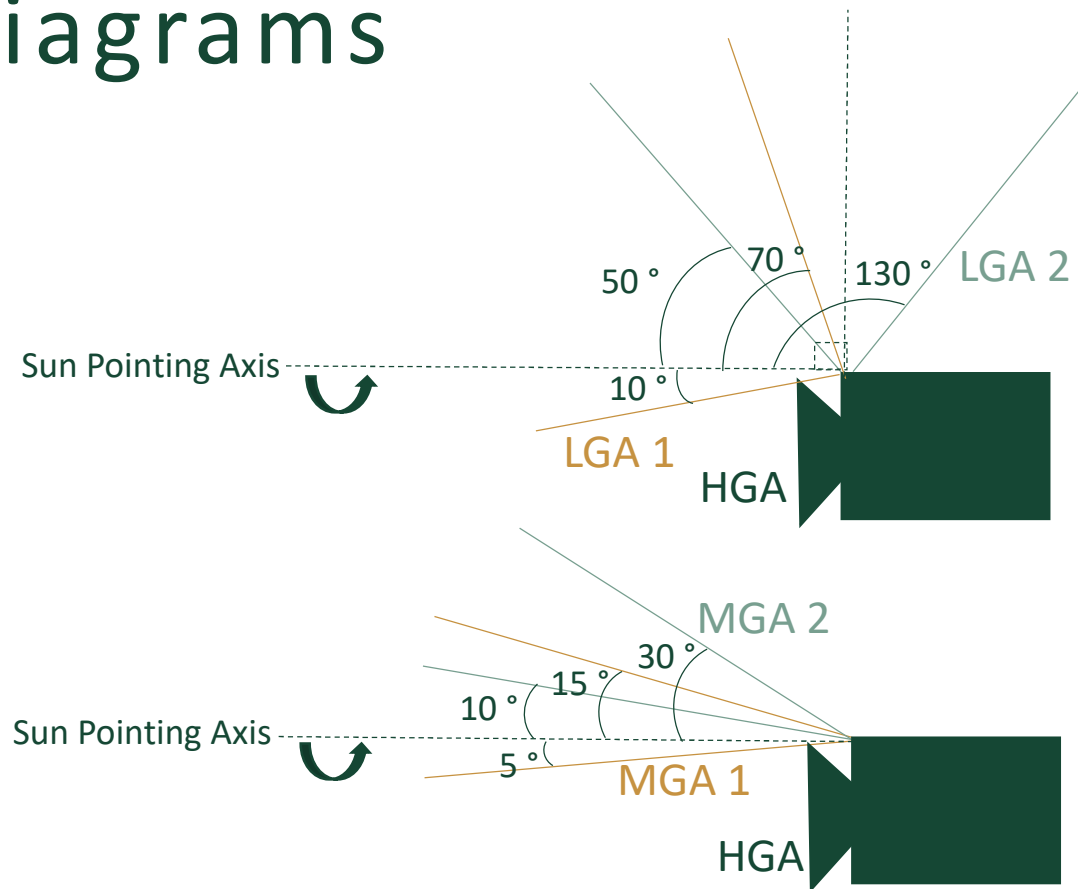

# Telecom Level 3 Requirements

ID	Requirement	Verification Method
COM1	The communication system shall transmit science data over a high gain downlink.	
COM2	The communication system shall transmit telemetry over a high gain downlink.	
COM3	The communication system shall be capable of transmitting telemetry over a medium gain downlink.	
COM4	The communication system shall be capable of transmitting telemetry over a low gain downlink.	
COM5	The communication system shall support ranging over a high gain link.	
COM6	The communication system shall support Doppler tracking over a high gain link.	
COM7	The communication system shall receive commands over a high gain uplink.	
COM8	The communication system shall be capable of receiving commands over a medium gain uplink.	
COM9	The communication system shall be capable of receiving commands over a low gain uplink.	
COM9	The communication system shall be capable of receiving commands over a low gain uplink.	
COM10	The communication system shall transmit science data at Ka-band.	
COM10	The communication system shall transmit science data at Ka-band.	
COM11	The communication system shall transmit telemetry at X-band.	
COM11	The communication system shall transmit telemetry at X-band.	
COM12	The communication system shall support ranging at X-band.	
COM12	The communication system shall support ranging at X-band.	

ST: ST: 0:00-0:00

# Telecom Level 3 Requirements

ID	Requirement
COM15	The communication system shall transmit science data with a minimum data rate of 32.4 kbps.
COM16	The communication system shall receive commands at a data rate of up to 2 kbps [TBC] during normal operations.
COM17	The communication system shall transmit telemetry with a data rate of TBD bps during normal operations.
COM18	The communication system shall transmit telemetry at a minimum data rate of 20 bps [TBC] while in system fault mode.
COM19	The communication system shall receive commands with a data rate of TBD bps during system fault mode.
COM20	The communication system shall be capable of continuous transmission.
COM21	The communication system shall be capable of continuous reception.
COM22	The communication system shall have a high gain transmission EIRP of 80.89 dBW [ TBC].
COM23	The communication system shall have a medium gain transmission EIRP of TBD dBW.
COM24	The communication system shall have a low gain transmission EIRP of TBD dBW.
COM25	The communication system shall comply with CCSDS format to communicate with the DSN.
COM26	The communication system shall have a minimum reliability of 98%.
COM27	The communication system shall have a mass of 117 kg +/- TBD kg.
COM28	The communication system shall have a volume of 0.072 m <sup>2</sup> +/- TBD m <sup>3</sup> .
COM29	The communication system shall operate in the space environment for 22 years.
COM20	The communication system shall operate at a heliocentric range of 0.5-7 AU.

---

# C&DH

---



**Jonathan Hood**

**Samuel Westrick**

**Solomon Dovich**

**Juan Carlos Flagg**

# Processing, Memory Calculations

Yellow: Assumptions  
Blue: Raw analog output  
Orange: Based on default values

Team	Data Source	Data Format Protocol (type)	Data rate (MB/s)	Data storage (MB)	Frequency (Hz)	Operation Time & Phase
FS-Payload	SAR	8-bit analog, no protocol, SpaceWire (can handle data rate, does point to point, no limit on packet size)	4.8	320.784	15600	*(ASSUMPTION) On for full encounter at max data rate (4/28 Matt Jones run of SAR model, bounded by resolution morphology constraints)
	Visual Imager					
	<i>Remote Obs.</i>	14-bit analog, SpaceWire	10.00	8078.4	5.347593583	*Remote Obs. (ASSUMPTION, see Editable Variables) Latest readout rate from Payload, 6 months campaign, 1hr cadence, all data stored onboard for full campaign, Visual only
	<i>Exoplanet</i>	***	***			*Exoplanet (ASSUMPTION, see Editable Variables) Latest readout rate from Payload, 4-week campaign, 30 min cadence, all data onboard for full campaign, Visual only
					1344	
	<i>OpNav/AutoNav</i>	***	***			*ASSUMPTION: no opnav/autonav images stored onboard; transmitted or processed directly.
	<i>Encounter</i>	***	***			* (ASSUMPTION) taking 60 images during encounter at 1.87 MB/image
	IR Imager	14-bit analog, SpaceWire	2.00	24		* (ASSUMPTION) taking 60 images during encounter at 0.4 MB/image
Health Sensors	Analog voltage for temp sensing (1553B)		1.87E-04	0.8064	4.67	* (ASSUMPTION: stored health data is downlinked weekly) Every phase, worst case 1/3 Hz frequency check

Return

# Processing, Memory Calculations

FS- Propulsion	Chem Prop Sensors	Floats (4 bytes)		3.91872	
	Thermocouples	1553B A	0.00252		630
	<i>Check Frequency (Hz)</i>	10			
	<i>Channels</i>	63			
	Pressure Transducers	1553B A	0.24		60000
	<i>Check Frequency (Hz)</i>	1000			
	<i>Channels</i>	60			
	Current/voltage Sensors:	1553B A	0.002	0.8064	4200
	Electric Prop sensors	Floats (4 bytes)	0.000204	8.22528	
	Thermocouples				51
	<i>Check Frequency (Hz)</i>	1			
	<i>Channels</i>	51			
	Pressure Transducers				510
	<i>Check Frequency (Hz)</i>	10			
	<i>Channels</i>	51			
PPU		0.004	0.08064	1000	
<i>Check Frequency (Hz)</i>	1000				
<i>Channels</i>	1				
Thrust Control	Digital PWM control	0			

Yellow: Assumptions

Blue: Raw analog output

Orange: Based on default values

Return

# Processing, Memory Calculations

FS-Power	Power Distribution Unit(s)	MIL-STD-1553	1.25	0	As needed	*(ASSUMPTION) using entire available data rate
	Health Sensors	1553B, A	0.002	0.8064	150	*two thermocouples and the PDU for current/voltage sensing
FS-Comms	Transponder	Spacewire	0	0		
	Redundant Transponder	Spacewire	0	0		
	Health Sensors	1553B, A	0.002	0.8064	1000	
FS-Thermal	Thermostat	readings, output analog volt (assuming 1553B due to required health data)	0.002	0.8064	50	Constantly operating; C&DH controls, rate unknown.
	Health Sensors	1553B, A	0.002	0.8064	200	
FS-GNC	APIC	RS-422	X kbps	How Much is Stored?	Readout rate, exp time?	Encounter Time, Phase 5
	Health Sensors	1553B, output A	0.002	0.8064	2000	
ADCS	Star Tracker (2x)	1553B	X kbps	How Much is Stored?	20	Constant, 10Hz, 4Hz
	IMU(s) (2x)	RS-422 converted to 485	X kbps	How Much is Stored?	400	Constant, 200 Hz
	CMGs x4	1553B	X kbps	How Much is Stored?	As needed	Constant
	Sun Sensor (x4)	RS-422 converted to 485	X kbps	How Much is Stored?	N/A	Constant

Yellow: Assumptions

Blue: Raw analog output

Orange: Based on default values

Return

# Processing, Memory Calculations

FS-Structures	Solar Array Drive Assemblies x2	RS-485	0	0		Command 0-48000 to turn to specific angle
	Electric Thruster Gimbal	RS-485	0	0		Command 0-64000 to turn to specific angle
	Thruster actuators x8	RS-485	0	0		
	x2 release mechanisms	RS-485	0	0		
	Health Sensors	1553B	0.002	0.8064	800	
	x2 array hinges	RS-485	0	0		
FS-C&DH	Comm cards--> Transponders	Spacewire (no limit packet size, high data rate)	400	0		Every Phase, downlink/uplink duration
	A2D Unit	Matches input and output	0	0		Every Phase, continuous
		<i>Types</i> Sigma-Delta	0	0	1.00E+05	24-bit resolution
		Successive Approx.	0	0	1.00E+06	16-bit resolution
		Flash	0	0	1.00E+08	12-bit resolution
	Interface Cards	Inputs Spacewire, RS422, 1553B, RS485	0	0		Every Phase, continuous
	Health Sensors	1553B	0.002	0.8064	200	
	Storage Unit	Backplane trace	X kbps	File storage protocol size		Every Phase, continuous. File structure may impact available storage
	Processing Units	Backplane trace	0	X flight software size		Every Phase, continuous. OS may impact available storage. (-55, 125 C operating temp, 10 <sup>1</sup> kg mass for 1 OBC+mass memory)

Yellow: Assumptions

Blue: Raw analog output

Orange: Based on default values

Return



# Processing, Memory Calculations

<b>Total</b>	Phase 1					*No Payload use, negligible storage
	Phase 2: C&DH		13.51	20342.04365	69610.01	*STORAGE: Includes 1 full year of data following the conceptual PP outline (full year of health data too)
	<i>Phase 2 Comms: 1 Week</i>			643.884		*TELECOM: Maximum new data onboard over the course of 1 week in Phase 2 assuming Exoplanet campaign
	Phase 3					*Looking for ISO, negligible storage
	Phase 4					*OpNav, negligible storage
	Phase 5: C&DH		18.31	563.478312	85210.01	*STORAGE: full encounter data + FOS
	<i>Phase 5: Comms</i>			469.56576		*TELECOM: full encounter data
	Phase 6: System-wide health, 1 week:				16.36992	*N/A
	System-wide health:				0.00081200	
					**includes C&DH factor of safety, used to size onboard storage	
				*does not include C&DH factor of safety, used to size Comms		

**Yellow:** Assumptions

**Blue:** Raw analog output

**Orange:** Based on default values

Return

# Processing Speed Assumptions

- Highest required during encounter: 85.24 kHz
- Includes health sensors from each subsystem (usually 2 per component)
  - C&DH : 50Hz
    - 2x voltage/current
    - 2x thermocouples
  - Structures : 50Hz
    - 8x voltage/current
    - 8x thermocouples
  - ADCS : 50Hz
    - 20x voltage/current
    - 20x thermocouples
  - GNC : 50Hz
    - 2x voltage/current
    - 2x thermocouples
- Comms : 50Hz
  - 10x voltage/current
  - 10x thermocouple
- Power : 50Hz
  - 2x thermocouple
  - 1x PDU output (volt/current all subcomponents)
- Propulsion : Variable Hz
  - 84x voltage/current (valve checking, 50 Hz)
  - 63x thermocouples (10 Hz)
  - 60x pressure transducers (1000 Hz)
- Payload : 0.3Hz
  - 7x voltage/current
  - 7x thermocouples

[Return](#)

---

# Processing Speed Assumptions

- Additional bandwidth comes from other subsystems during operation
- Payload:
  - SAR: 15.6 kHz
  - Visual/IR Imager: 35.34 Hz
- ADCS:
  - Star Tracker x2: 10 Hz
  - IMU x2: 200 Hz

[Return](#)

# Wire Protocol Characteristics

Potential Protocols	Multidrop?	Data Rate (MB/s)	Standard cable	Mass per unit length (kg/m)	Cable diameter (in)	Operating Temperature Range (°C)	Waste heat/ other thermal properties
RS-422	No	1.25	EIA Industrial RS-422 PLTC/CM	0.036	0.23	-40 to 75	Negligible
SpaceWire	No	400	Full-duplex	0.085	0.281	-100 to 180	Negligible
1553B	Yes	1	Twinax	0.061	0.244	-20 to 60	Negligible
RS-485	Yes	1.25	EIA Industrial RS-485 PLTC/CM	0.143	0.03	-20 to 60	Negligible

[Return](#)

# Wire Protocol Rationale

- ADCS
  - CMGs: 1553B, required
  - Star Tracker: 1553B, required
  - Sun Sensors & IMUs: RS-485, modified.
    - 6 discrete RS-422 connections required; included an RS-485 Arbitrator to convert RS-422 connections to one multidrop-capable RS-485 connection to simplify physical integration
- Structures
  - Thruster Actuators (x8), SADAs (x2), Array Hinges (x2), Release Mechanisms (x2): RS-485, selected.
    - Capable of most protocols except 1553B; selected the other multidrop protocol, RS-485, to reduce incoming wire connections from 14 discrete to one combined
- Power
  - PDU (x2): 1553B, required

[Return](#)

# Wire Protocol Rationale

- Propulsion
- Pressure Transducers (x60): 1553B, selected.
  - Each transducer is equipped with a miniature ADC to produce a digital signal. To avoid 60 discrete connections, the signals are routed into a 1553B connection, reading each transducer at 1000 Hz intervals (requested by Propulsion)
- Fuel Valves (x?): no protocol, digital, required.
  - Valves operate via PWM; C&DH sets a digital duty cycle and, when “HIGH”, the valves open, allowing fuel flow and thrust, and when “LOW”, close the valves.
- Health Sensors, 1553B, selected.
  - All sensors are analog signals individually connected to ADCs
  - All sensors except thermal sensors on Payload, ADCS, GNC are routed to C&DH via 1553B to take advantage of low data rate and multidrop capabilities
  - Thermal sensors on Payload, ADCS, and GNC are looped internally and controlled via subsystem-specific preexisting processors already in use. Thermal data is included in science/regular data downstream. Mechanical thermostat keeps them in survival temperature range when not in use

[Return](#)

# Wire Protocol Rationale

- Payload
  - Optical: SpaceWire, modified.
  - IR: SpaceWire, modified.
  - SAR: SpaceWire, modified.
    - All payload instruments output analog signals of varying packet size and data rates. Each is equipped with an ADC and then passed into a SpaceWire formatted wire, capable of very high (400 MB/s) data rates and of variable packet sizes. SpaceWire is a discrete connection.
- Telecom
  - Transponder (x2): SpaceWire, selected.
    - To avoid wire data rates becoming a limiting factor to uplink/downlinking, SpaceWire was selected (400 MB/s). SpaceWire is also capable of varying its packet size, and can follow any desired Telecom turbocode encoding scheme.

[Return](#)

# Duration Budget: PP Orbit

PP Orbit (1 Year Plan)							
Within Duration Budget							
Arrival Date:	12/31/2030						
DSN contact frequency (/week):	1						
DSN contact duration (hours)*:	0.5						
Num. of remote obs. campaigns:	1						
Remote obs. Image cadence (/hr):	1						
Duration of Remote Obs. Campaign (months):	6	*GS, 4/19, Alexi D.					
Num. of exoplanet obs. campaigns:	6	*GS, 4/19, Alexi D.					
Duration of Exoplanet Obs. Campaign (weeks):	4	*SS, Jon H. 4/19					
Exoplanet Image cadence (/hr):	2	*SS, Jon H. 4/19					
Default Health Sensor Frequency (Hz):	50	*SS, Jon H. 4/19					
Default # of Channels (x2 redundancy, health sensor):	10	*Adjusted to fill remaining time					
Default Health Data Size (bytes):	4	*SS, Jon H. 4/19					
Default Data Rate (MB/s):	0.002	*SS, Jon H. 4/19					
Default Storage Rate (Hz):	0.033333333	*Jon H 4/26, for sizing					
Stored Health Data (#):	20160	*Jon H 4/26, for sizing					
		*Float, bytes assumption 4/26					
Total Duration (days):	349.0833333	*Calculated from above					
Available time (days):	15.91666667	*Assumed stored health data every 30 seconds, Jon H 4/26					
*NOTE: duration is purely communication downlink, does NOT		*assumed # of health data points to downlink for each system if health data is stored every 30 seconds					

Return



# Duration Budget: Encounter

Encounter Timeline				
Within Duration Budget				
Total Allowed Encounter Duration (min):	9.2674	*5/17, Liam		
Visual Imager Time (min):	0.19	* calc from below		
IR Imager Time (min):	0.20	* calc from below		
SAR Operation Duration (min):	1.7324	*5/17, Liam		
Required Duration (min):	0.39			
Imager Operation Duration (min):	0.39	*calculated from below assuming image taken does not overlap with image readout		
Time in IR Imager Operational Range (min):	4.67	*5/17, Liam		
Time in Visual Imager Operational Range (min):	2.87	*5/17, Liam		
Remaining Visual Imager Available Duration (min, total):	2.68			
Remaining IR Imager Available Duration (min, total):	4.47			
Remaining Available Duration (min, total):	8.8804			

[Return](#)

# Duration Budget: Assumptions

SAR # of Pulses:	41	*Matt Jones, 5/21			
Pulse Duration (sec):	1.63	*Matt Jones, 5/21			
Visual Image Num During Encounter:	60.00	*Lauren F, worst case from Encounter Meeting 4/26			
IR Image Num During Encounter:	60.00	*Lauren F, worst case from Encounter Meeting 4/26			
Visual Smallest Exp. Time (sec):	0.013	*PDR slides 5/24, formerly 0.023			
IR Smallest Exp. Time (sec):	0.00	*Matt Jones, 5/5			
Visual Readout Rate (sec):	0.1870	*PDR slides 5/24; 200 ms total, so -exposure time for readout rate. Formerly 0.0283			
IR Readout Rate (sec):	0.2000	*PDR slides 5/24			
IR Image size:	0.40	*MB, 4/19 Colleen			
Visual Image Size:	1.87	*MB, 4/19 Colleen			
C&DH Data Factor of Safety:	1.20	*4/19 Solomon D., value over expected maximum storage required			

[Return](#)

# C&DH Requirements: Level 3

Level	ID	Parent	Requirement	Rationale
3	CDH1	F1, F30	The C&DH system shall be capable of responding to commands received from ground.	The C&DH subsystem will be responsible for interpreting commands from Earth and controlling the necessary functions of each subsystem as a result. The system must be capable of receiving and immediately implementing commands for situations where immediate action is necessary.
3	CDH2	F9, F11, F12, F13, F14, F15, F16	The C&DH system shall be capable of storing commands for delayed execution.	The C&DH subsystem will be responsible for interpreting commands from Earth and controlling the necessary functions of each subsystem as a result. The system must be capable of storing these received commands and executing a sequence at a designated later time (like imaging campaign).
3	CDH3	F17, F20	The C&DH system shall store data until receipt is confirmed by the ground system.	The flight system will need to verify that data has been received by ground before deleting from storage.
3	CDH4	F3, F5, F15, F16, F20, F31, F33	The C&DH system shall decode data received from the ground system.	C&DH Comms cards will be responsible for decoding data received from ground and turning it into command form that can be sent to C&DH.
3	CDH5	F3, F5, F17, F18, F19, F21, F28	The C&DH system shall encode data prior to transmission to the ground system.	C&DH Comms cards will be responsible for encoding data sent to ground.

# C&DH Requirements: Level 3

Level	ID	Parent	Requirement	Rationale
3	CDH6	F17	The C&DH system shall track elapsed time with an accuracy of +/- 1 millisecond.	Commands will need to be executed at a designated time. Additionally, the spacecraft will need to propagate position data onboard. In order to this, the C&DH system will need to accurately track elapsed time. The accuracy of +/- 1 millisecond was estimated with information from the deep space communications lecture.
3	CDH7	F11, F12, F13, F14	The C&DH system shall have a storage capacity of 21 GB [TBC].	The C&DH system needs to store science and telemetry data collected until there is a communication opportunity. The data storage was sized to accommodate several varieties of pre-positioned orbit observational campaigns
3	CDH8	F9, F11-F21, F28, F30, F31, F33	The C&DH system shall support the ADCS subsystem flight algorithms.	The C&DH subsystem will be responsible for supporting the ADCS components. The specific components are outlined in the Data Definition Presentation.
3	CDH9	F3, F5, F9, F11-F21, F28, F30, F31, F33	The C&DH system shall support of the ADCS subsystem file format protocols.	
3	CDH10	F10, F17-F22, F28, F30, F31, F33	The C&DH system shall support the Communications subsystem flight algorithms.	The C&DH subsystem will be responsible for supporting the Telecom components. The specific components are outlined in the Data Definition Presentation.

# C&DH Requirements: Level 3

Level	ID	Parent	Requirement	Rationale
3	CDH11	F10, F17-F22, F28, F30, F31, F33	The C&DH system shall support the Communications subsystem file format protocols.	
3	CDH12	F9, F15, F16	The C&DH system shall support the GNC subsystem flight algorithms.	The C&DH subsystem will be responsible for supporting the GNC components. The specific components are outlined in the Data Definition Presentation.
3	CDH13	F9, F15, F16	The C&DH system shall support the GNC subsystem file format protocols.	
3	CDH14	F9, F11-F14, F24, F25, F27, F29	The C&DH system shall support the Payload subsystem flight algorithms.	The C&DH subsystem will be responsible for supporting the Payload components. The specific components are outlined in the Data Definition Presentation.
3	CDH15	F9, F11-F14, F24, F25, F27, F29	The C&DH system shall support the Payload subsystem file format protocols.	

# C&DH Requirements: Level 3

Level	ID	Parent	Requirement	Rationale
3	CDH16	F5	The C&DH system shall support the Power subsystem flight algorithms.	The C&DH subsystem will be responsible for supporting the Power components. Power is required for the spacecraft to operate in space for 22 years. The specific components are outlined in the Data Definition Presentation.
3	CDH17	F5	The C&DH system shall support the Power subsystem file format protocols.	
3	CDH18	F15, F16	The C&DH system shall support the Propulsion subsystem flight algorithms.	The C&DH subsystem will be responsible for supporting the Propulsion components. The specific components are outlined in the Data Definition Presentation.
3	CDH19	F15, F16	The C&DH system shall support the Propulsion subsystem file format protocols.	
3	CDH20	F5	The C&DH system shall support the Structures subsystem flight algorithms.	The C&DH subsystem will be responsible for supporting the Structures components. The specific components are outlined in the Data Definition Presentation.

# C&DH Requirements: Level 3

Level	ID	Parent	Requirement	Rationale
3	CDH21	F5	The C&DH system shall support the Structures subsystem file format protocols.	The C&DH subsystem will be responsible for supporting the Structures components. The specific components are outlined in the Data Definition Presentation.
3	CDH22	F3	The C&DH system shall have a minimum reliability of 99.8%.	In order to achieve an 80% likelihood of reaching and identifying at least one ISO in 20 years, the flight system must have an overall reliability of at least 90%. The breakdown of this reliability into the individual reliabilities of subsystems is described here.
3	CDH23	F5	The C&DH system shall operate in the space environment for 22 years.	The flight system will be operating in the space environment for at least 22 years, therefore the C&DH subsystem must operate in this environment for the listed time period.
3	CDH24	F10	The C&DH system shall operate at a heliocentric range of 0.5-7 AU.	The flight system will be at a range of 0.5 to 7AU from the Sun, therefore the C&DH subsystem must be able to operate in this environment.

# C&DH Requirements: Level 4

Level	ID	Parent	Requirement	Rationale
4	CDH-C1	CDH3	The data storage shall store science data collected from the ISO.	Long-term hard storage holds flight system science data for downlink to ground
4	CDH-C2	CDH3	The data storage shall store flight system telemetry data.	Long-term hard storage holds flight system telemetry for downlink to ground
4	CDH-C3	CDH2	The data storage shall store commands from the ground system.	To hold commands for long-term delayed execution, they are stored in the MMC instead of in flash memory
4	CDH-C4	CDH1, CHD2	The processors shall employ flight software capable of handling ground system commands.	Created FS for OBC interprets received GS commands
4	CDH-C5	CDH20	The 1553B interface card shall provide wire protocol to SpaceWire backplane protocol.	Provide wire protocol to backplane protocol interface for each required protocol



# C&DH Requirements: Level 4

Level	ID	Parent	Requirement	Rationale
4	CDH-C6	CDH9, CDH13	The RS-485 interface card shall provide wire protocol to SpaceWire backplane protocol.	Provide wire protocol to backplane protocol interface for each required protocol
4	CDH-C7	CDH15	The SpaceWire interface card shall provide wire protocol to SpaceWire backplane protocol.	Provide wire protocol to backplane protocol interface for each required protocol
4	CDH-C8	CDH4	The X-band communication card shall decode uplinked commands.	DSN uplinks in X-band to the HGA and requires turbo-decoding
4	CDH-C9	CDH5	The X-band and Ka-band communications cards shall encode downlinked commands/telemetry.	DSN downlinks in X and Ka-bands and requires turbo encoding
4	CDH-C10	CHD27	The power card shall regulate power into the C&DH subsystem.	Power regulation is necessary for efficient OBC operation.

# C&DH Requirements: Level 4

Level	ID	Parent	Requirement	Rationale
4	CDH-C11	CDH12	The processor card shall have at least 5 MB of RAM.	GNC's APIC optical autoNav processing card requires 5 MB of RAM to run.
4	CDH-C12	CDH8-21	The processor card shall handle at least 85.21 kHz bandwidth.	Full system requirement
4	CDH-C13	CDH22	The C&DH subsystem shall have a redundant copy of itself.	To meet reliability requirements, there will be two separate C&DH subsystems capable of taking over for the other in the event of a fault.
4	CDH-C14	CDH22	Each C&DH subsystem shall have a redundant mass memory card.	To meet reliability requirements, there will be two separate mass memory cards in each C&DH system. When storing data, data will be written to each card and checked for errors when downlinking.

---

# C&DH Risks

- Given that there is an unknown distribution and direction of energetic particles from a solar particle event or CME there is a possibility of the flight system being impacted by energetic particles adversely impacting the memory storage device and processor card, which can result in a loss or change in data stored in the memory device and the processor card being unable to properly process data.

---

# Structures

---



**Matthew Slymen**



**Ismael Castorena**



**Ricardo Contreras**

**Anthony Garcia**



**Saul Portillo**

**Edgar Yanez**

# System Design?

## *Driving Configuration Requirements*

ID	Requirement	Driving Phase	Compliance (Y/N/M)
MP2	The flight system shall fit within a volume of 175.15 m <sup>3</sup> [TBC] with the dimensions specified in Figure 1.	Phase 1	Y
STR2	The structure shall have a center of mass with a height above the SIS interface as specified in Figure 3-2 in the Falcon Heavy User Guide.	Phase 1	M
STR13	The structure shall interface with the launch vehicle.	Phase 1	Y
STR 14	The structure shall provide interfaces to mount all components on the flight system.	N/A	N



---

# Structures Risks

- Given that the mechanism to deploy the instrumentation does not deploy or gets jammed there is a possibility of the mechanisms not deploying adversely impacting any component that is gimbaled or deployed, which could result in the spacecraft not collecting data, power, or not directing its thrust.
- Given that we can come across unanticipated launch loads or launch environments there is a possibility of the

spacecraft shaking more than anticipated adversely impacting the entire spacecraft, which can result in a structural integrity compromise or component failure.

Likelihood: 1

Severity: 2

# Mechanisms - Structures

Mechanism	Source	Mass	Continuous Draw	Actuation Draw	Actuation Type	Range	Resolution	Operating Temperatures
SADA (x2)	<a href="#">MOOG High Power Type 5</a>	40kg	<20W	20W	Motor	+/-179 deg.	+/-0.02 deg.	-50 C to +70 C
Thruster Ring Actuator (x8)	<a href="#">MOOG 310</a>	16kg	<28VDC	28VDC	Motion translation (rotational to linear)	2cm stroke	Future Work	-50 C to 80 C
Roll Out Solar Arrays (ROSAs, x2)	<a href="#">DSS ROSA</a>	600 kg	N/A	N/A	Roll out	N/A	N/A	-65 C to +90 C
Non-Explosive Actuator for ROSA (x2)	<a href="#">EBAD NEA HDRM</a>	4.3kg	250 mA	4 A (release current)	Hold Down and Release	N/A	N/A	-240 C to +135 C
Deployment Hinge for ROSA (x2)	<a href="#">Deployment System for Large Appendages</a>	3kg	N/A	N/A	Spring driven	90-180 deg.	+/- .006 deg	-30C to +50 C (Survivable temperatures +/-150 C)
Non-Explosive Actuator for SAR	<a href="#">NEA Model 9100</a>	0.7kg	250 mA	4A	Hold Down and Release	N/A	N/A	-135C to +135C
Deployment Hinge for SAR	<a href="#">Deployment System for Large Appendages</a>	1.5kg	N/A	N/A	Spring driven	90-180 deg.	+/- .006 deg	-30C to +50 C (Survivable temperatures +/-150 C)
APIC Gimbal	<a href="#">JPL</a>	<5kg	<12W	<12W	Elevation Actuator	+/-90	19 microrad	Actively controlled
Primary Imager Lens Cap	Future Work							

**Total Mechanisms:** approx. 20

# SADAs

**Model Number: MOOG High Power Type 5**

**Source:** [MOOG High Power Type 5](#)

**Notes:**

- Suited for 9kW through the system, scaled SMaP values x2 to accommodate for further mechanism development
- [Mechanisms – Structures](#)





# ROSAs

Model Number: Deployable Space Systems ROSA

Source: [Deployable Space Systems ROSA](#)

**Notes:**

- Roll out mechanism is the carbon fiber slit tubes on both sides (uses the tubes stored strain energy)

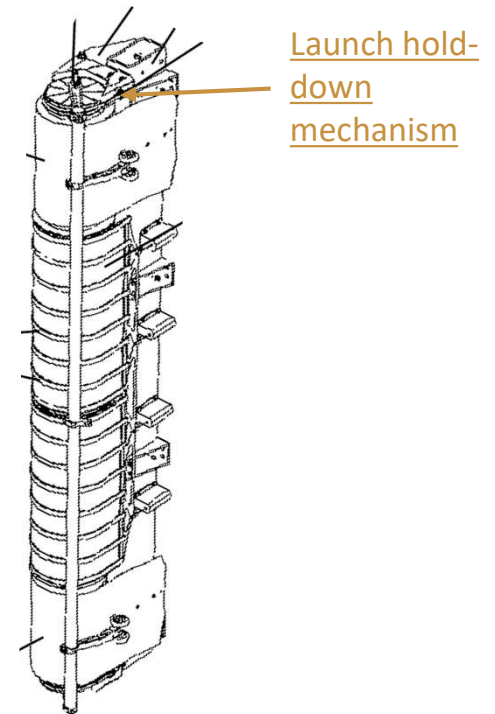
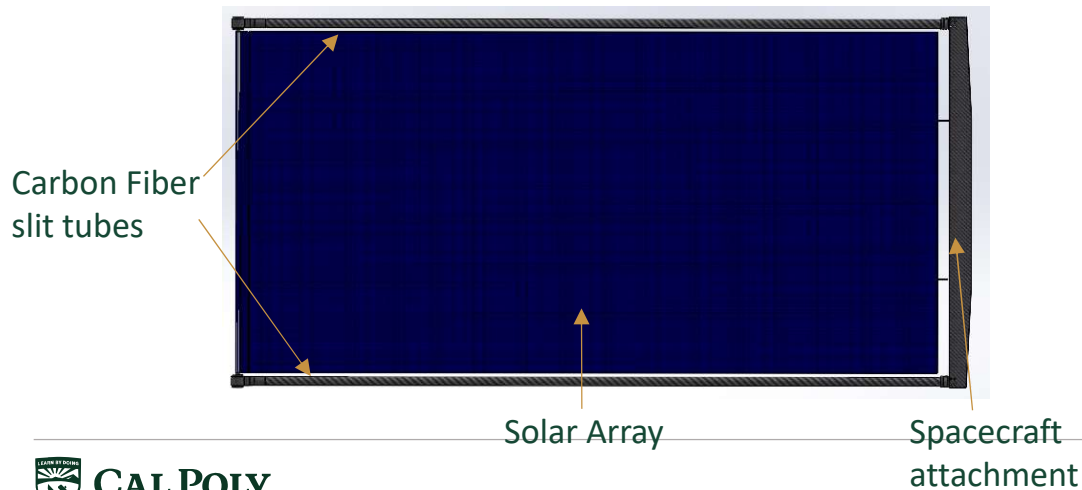

[Mechanisms - Structures](#)

## Thruster Ring Linear Actuators

**Model Number:** MOOG 310 Linear Actuator

**Source:** MOOG 310

### Notes:

- Two actuators needed for control of each of four thrusters for total of eight actuators
- Mechanisms - Structures



# Non-Explosive Actuator for ROSA: Hold Down and Release Mechanism

**Model Number: EBAD NEA HDRM**

**Source:** [EBADNEAHDRM](#)

**Notes:**

- Allows for 6 degree cone of misalignment
- <50 ms release time
- 195 kN release load rating
- [Mechanisms - Structures](#)

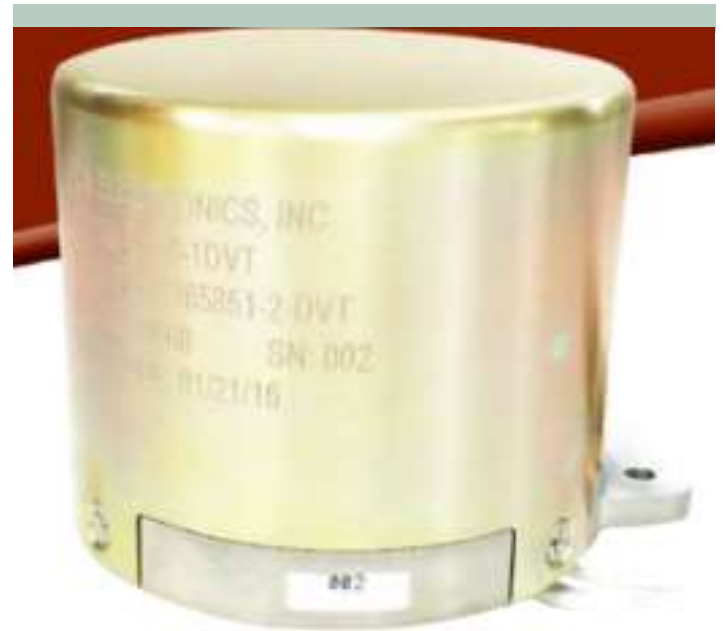

## Deployment Hinge for ROSA

**Model Number: DESY**

**Source:** [DESY\(Deployment System for Large Appendages\)](#)

**Notes:**

- Spring Driven, High Position accuracy and stiffness in deployed configuration
- Used for deployment of large appendages such as solar arrays & antennas
  - [Mechanisms - Structures](#)



# Non-Explosive Actuator for ISAR

**Model Number:** EBAD NEA 9100 HDRM

**Source:** [EBAD NEA HDRM](#)

**Notes:**

- Allows for 6 degree cone of misalignment
- <50 ms release time
- 7.6 kN release load rating
- [Mechanisms - Structures](#)



# APIC Mechanism

**Model Number:** Advanced Pointing Imaging Camera Concept

**Source:** [APIC](#)

## Notes:

- Comes pre-installed in APIC assembly, not a mechanism we need to design
- See GNC for more information
- [Mechanisms - Structures](#)

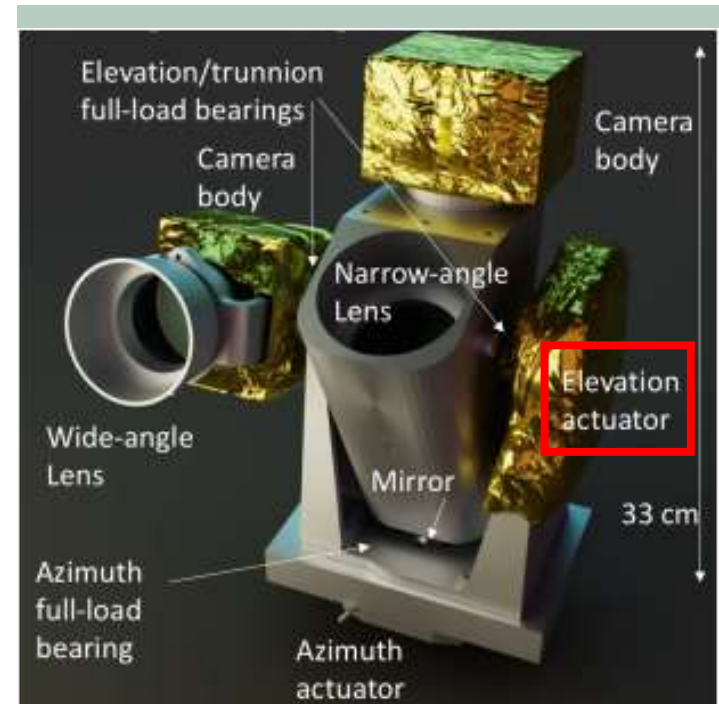

---

# Driving Configuration Considerations

1. Adaptability
  1. Spacecraft must be able to point in a variety of directions for different ISO cases
2. Minimum Structural Mass
  1. Configuration must allow for small structural mass for maximum fuel
3. Large Tanks and High Gain Antenna
4. High Power Requirement

# Phase Timeline 0 thru 1

## Phase 0: PreLaunch

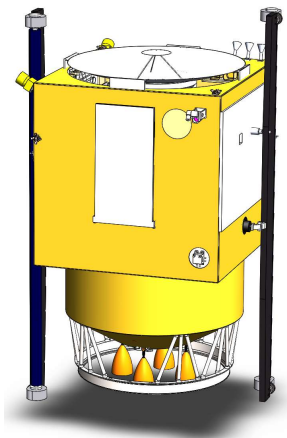

### Primary Points

- N/A

### Mechanisms in use

- N/A

## Phase 1: Launch to Separation

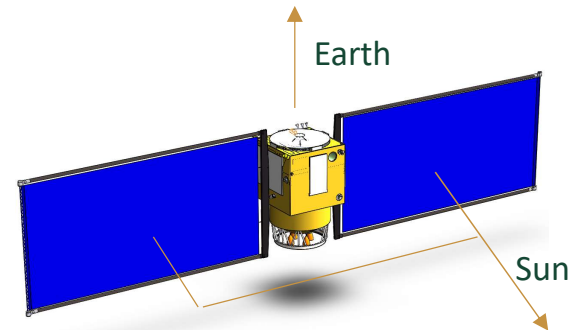

### Primary Points

- HGA – Pointed to Earth
- Solar Array – Pointed to Sun

### Mechanisms in use

- Solar Drive Mechanism



# Phase Timeline 6 thru 7

Phase 6: Downlink Data

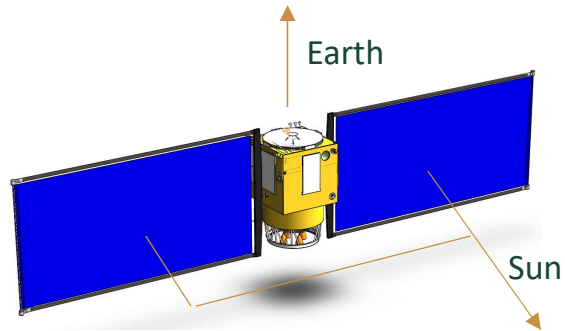

### Primary Points

- HGA – Pointed to Earth
- MROSAs – Pointed to Sun

### Mechanisms in use

- Solar Drive Mechanism

Phase 7: EOL

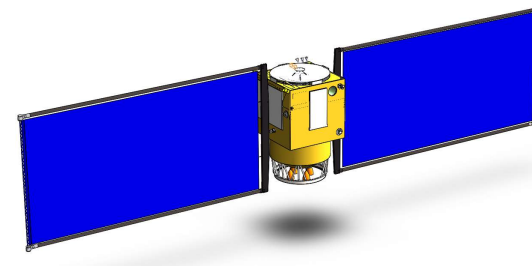

### Primary Points

- N/A

### Mechanisms in use

- N/A

# MMOD Shielding Study

[Link to Main](#)

MMOD shielding consist of aluminum honeycomb sandwich panel and MLI shielding.

- The shield dimensions are 1 mm wall thickness on each side with a 5 cm honeycomb core. This shield can protect against particles with a critical diameter up to 1.5 cm.
- Grunmodel and MEM3 was used to determine MMOD flux environment. That then determines the probability of particles impacting that could cause failure.
- At the 1 AU prepositioned orbit we have a 98.38% probability of avoiding impacts of particles with a diameter of +0.2 cm
- During an Earth fly by we have a 99.34% probability of avoiding impacts of particles or orbital debris with diameters of +0.032 cm
- To determine if shielding can protect against the coma or tail of an ISO, model information on 2I/Borisov was used. For most studies, the particles diameters ranged from 1E-3 cm to .4 cm with the smaller particles reaching velocities up to 50 m/s

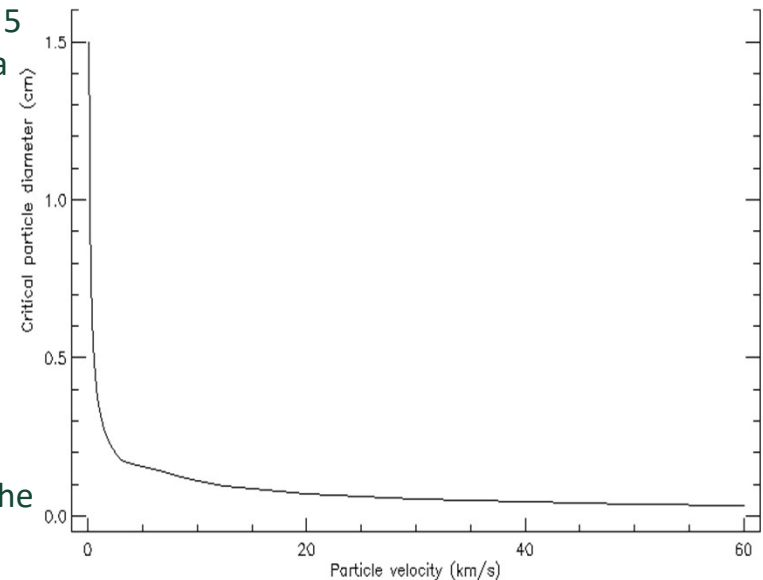

# MLI Shielding Study

- The MLI shielding is a 15 mm thick, 30 layer blanket consisting of aluminized Mylar and tulle
  - The packing density chosen is 30 layers/15 mm due to the decrease in conductive shorting with less dense packing
  - The tulle is used as a spacer to prevent shorting as well
  - The decision to use this configuration is based on experimental studies in which number of layers and packing density were varied and a NASA study which saw diminishing returns past 20 layers
  - The heat flux through the 30-layer blanket was about  $.07 \text{ W/m}^2$  less than the 20-layer blanket
- Due to the spacecraft's varied orientation, the entire spacecraft bus will be covered in MLI including the HGA which will be covered in a Germanium coated polyimide, which is RF transparent

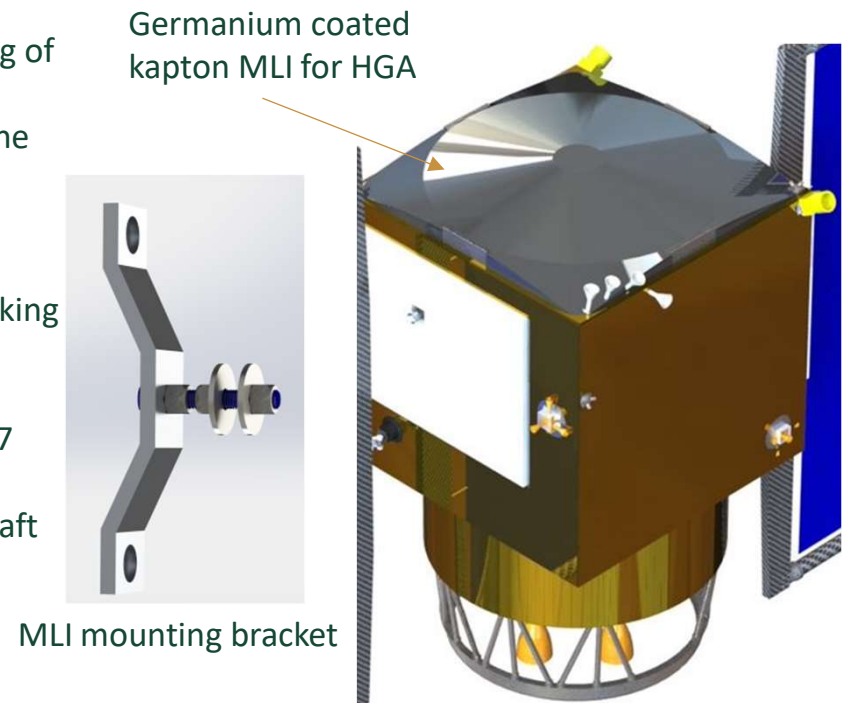

# Structural Factor of Safety Table

Table S1

Factor of Safety per Material						
Material Type	Verification Approach	Additional Considerations	Ultimate Design Factor	Yield Design Factor	Qualification Test Factor	Proof Test Factor
Metallic	Prototype	N/A	1.4	1.0 <sup>1</sup>	1.4	N/A or 1.05 <sup>2</sup>
	Protoflight	N/A	1.4	1.25	1.2	N/A or 1.05 <sup>2</sup>
Composite/Bonded	Prototype	Discontinuity Area Geometry	2.0 <sup>3</sup>	N/A	1.4	1.05
		Uniform Geometry	1.4	N/A	1.4	1.05
	Protoflight	Discontinuity Area Geometry	2.0 <sup>3</sup>	N/A	1.2	1.2
		Uniform Geometry	1.5	N/A	1.2	1.2
Glass/Ceramics	Proof Test	Nonpressurized Loading Condition	3	N/A	N/A	1.2
		Pressurized Loading Condition	3	N/A	N/A	2
	Analysis Only <sup>4</sup>	Nonpressurized Loading Condition	5	N/A	N/A	N/A
Bonds in Glass/Ceramics	Proof Test	Nonpressurized Loading Condition	1.5	N/A	N/A	1.2
		Pressurized Loading Condition	3	N/A	N/A	2
Softgoods	Prototype and Proof Tests	Loss of Life or Vehicle Criticality	4	N/A	4	1.2
		Any Other Criticality	2	N/A	2	1.2
Beryllium	Proof Test	None	1.6	1.4	N/A	1.2

[Return to Main](#)

<sup>1</sup>Structure has to be assessed to prevent detrimental yielding during its design service life, acceptance, or proof testing.

<sup>2</sup>Propellant tanks and SRM cases only.

<sup>3</sup>Factor applies to concentrated stresses. For nonsafety-critical applications, this factor may be reduced to 1.4 for prototype structures and 1.5 for protoflight structures.

<sup>4</sup>Not applicable to ceramic structures.

# Structures Flow

[Link to Main Analysis Slides](#)

CAD (Solid Features)

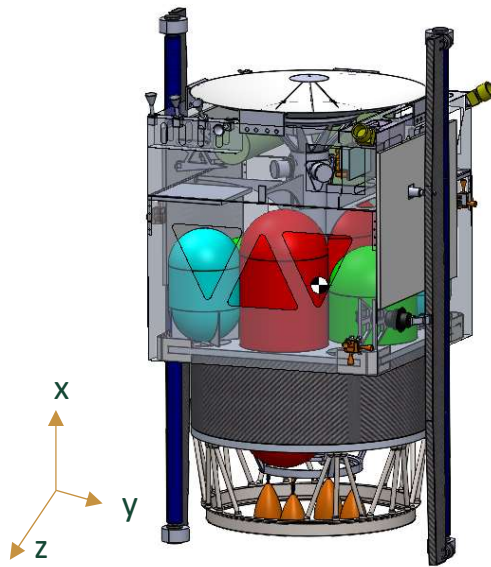

Geometry Pre-Processing

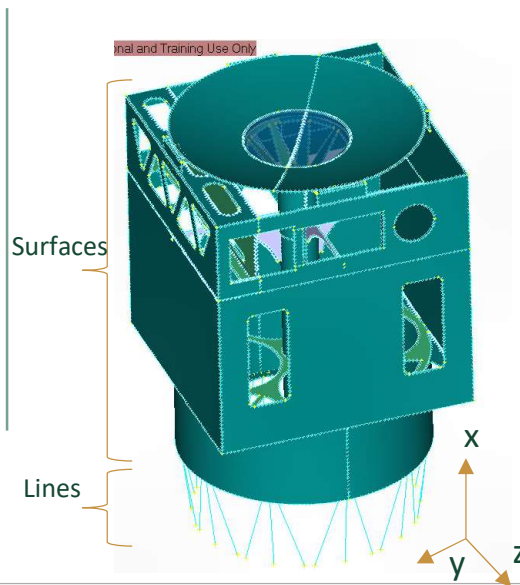

Meshing and BC

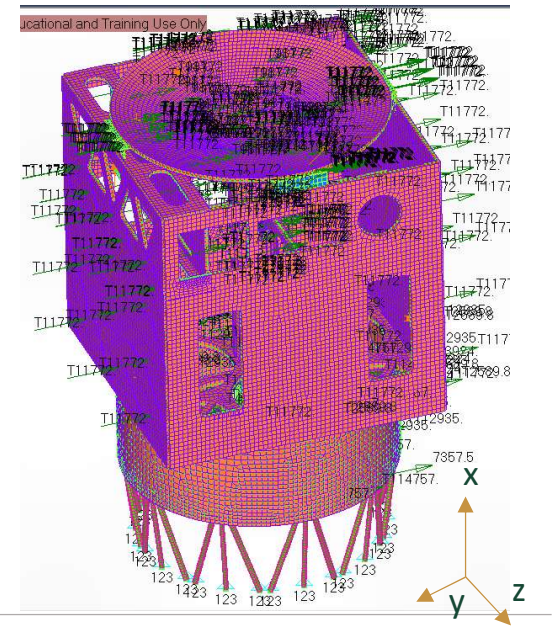

# FEM

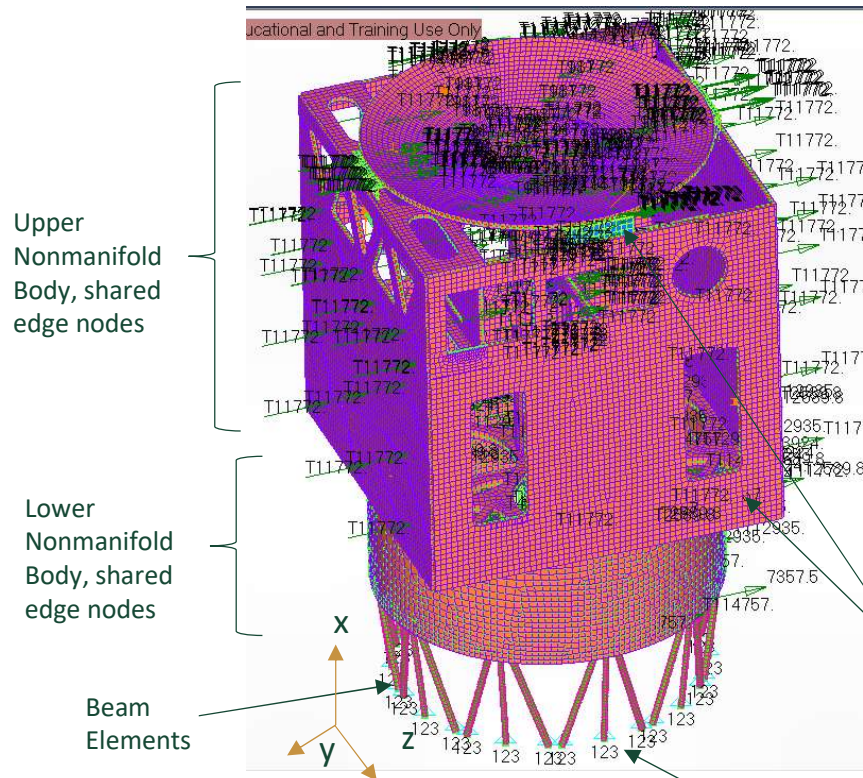

## Materials:

- Various thicknesses of 7075Al Facesheets/Hexcel Al Honeycomb Core
- Various thickness of 7075Al Plates
- Various Thicknesses of Ti-6Al-4V (Bracketry and Beams)

## Loads:

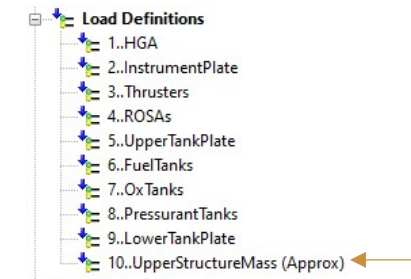

Remaining "Unaccounted for" mass  
(Primarily Structural mass)

Bracketry to connect regions with contact (glue) segments

Pinned Base



# Modal Results (2) <35Hz (Open Issue)

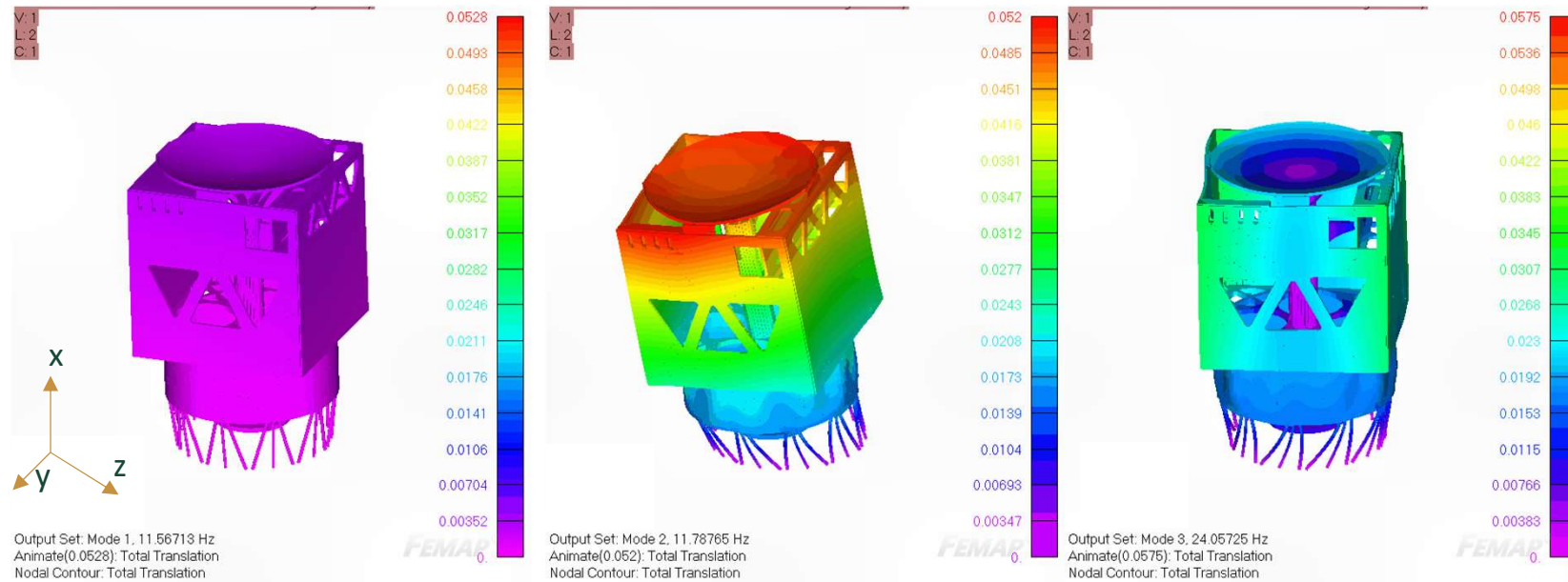

**Mode 1: 11.5Hz**  
Max Translation: 5.3cm  
LV Limit: <7cm

**Mode 2: 11.8Hz**  
Max Translation: 5.2cm  
LV Limit: <7cm

**Mode 3: 24.1Hz**  
Max Translation: 5.8cm  
LV Limit: <7cm

# Modal Results (3) <35Hz (Open Issue)

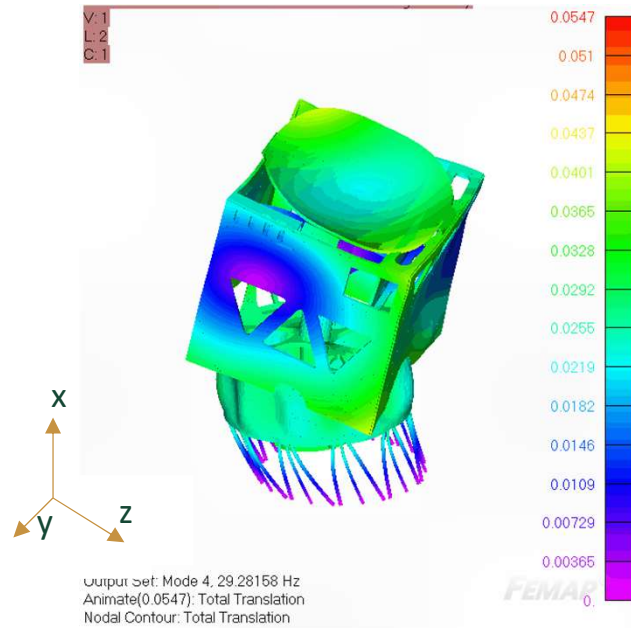

**Mode 4: 29.3Hz**  
Max Translation: 5.5cm  
Required: 7cm?

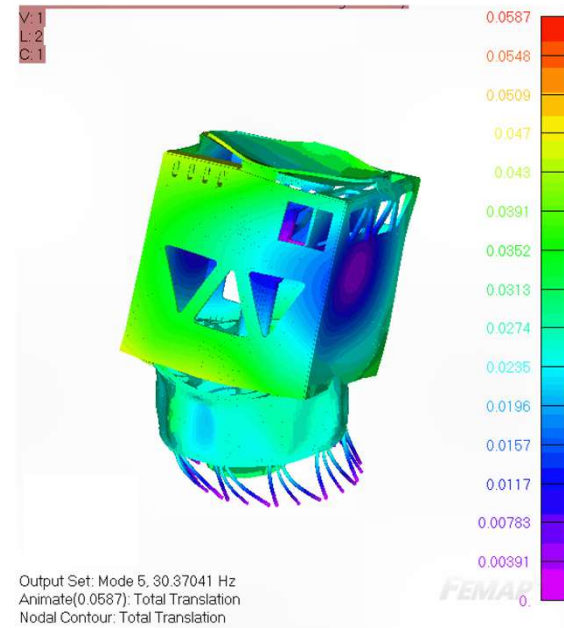

**Mode 5: 30.4Hz**  
Max Translation: 5.9cm  
Required: 7cm?



# Analysis Next Steps

## Post-PDR

- Finalize Modal Analysis
- Random Vibration
- Structural Optimization
- Further Bracketry for instrumentation
- Vibration dampening systems for subsystems
- Operational Loading Conditions
  1. Thrusters On
  2. Deployment Loads
  3. Control Torques

# Analysis Summary

## Static Loading

Load Case	Min/Max	Location
6G Axial Stress	FOS = 1	Upper Payload Box
6G Axial Translation	Deflection = 2.9cm	Center Column, upward
2G Lateral Stress	FOS = 1.25	LV Attachment Tubes
2G Lateral Translation	Deflection = 3.9cm	Top Corner, sideways

Ready for Refinement

## Modal Analysis

Mode	Resonant Frequency	Max Translation
1	11.5Hz	5.3cm
2	11.8Hz	5.2cm
3	24.1Hz	5.8cm
4	29.3Hz	5.5cm
5	30.4Hz	5.9cm

Further Design Required

---

# Power

---



**Karen Llaca**



**Joseph Poncini**



**Ethan Tran**

---

# Power Risks

- Given that electronic arcing occurs there is a possibility of electric failure adversely impacting the number of solar cells we have in series, which can result in reduced power availability.

Likelihood: 2

Severity: 2

# Solar Array and Batteries



## Solar Array Design:

- Sizing for ROSA panel dependent on most power sensitive portions of the power budget. Model is slightly over conservative on degradation rate (~1.25% yr) for expected 23.75 yr lifetime and average 10 deg cosine loss.
- Shifted panel design to a different heavier variant of the ROSA solar panels. More accurate density and improved cell efficiency compared to previous ROSA panel.
  - For full chem prop system investigated panel solutions between 2-6 panels.
- Temperature degradation assumed most impactful for 1 AU prepositioned phase.
  - Investigating panel orientation during preposition to reduced sun facing area to aid station keeping and thermal loads

## Battery Design:

- Time from initial launch separation to array deployment is taken to be about 2 hours ( This includes detumble and ROSA roll out)
  - At ~28 V bus voltage thus expecting a min battery capacity of 64.035 Ah
- Previous optimized battery had about 255 Ah capability and 5p10s configuration. Need for larger sized battery constrained by science collection phase and downlink at Au ranges past 4.
  - ~8324 Wh new battery capacity after applying 8% degradation factor and assumption that 1 open parallel cell leaves 10 cells inactive.

Rosa Array Output Including Degradation Effects and Cosine Losses

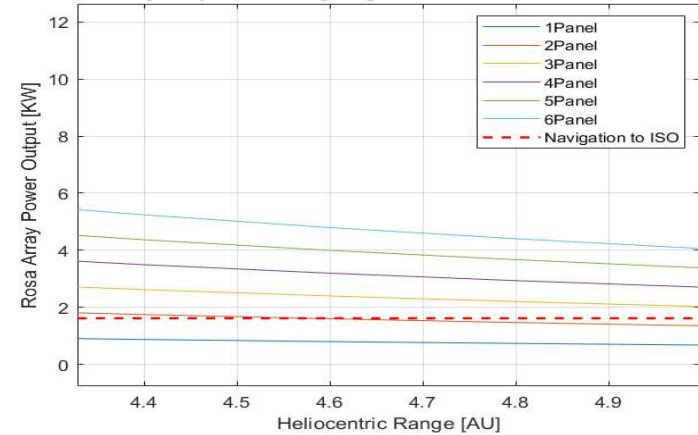

Table 1. New ROSA Variant Array Specifications

Size Deployed (m <sup>2</sup> )	Size Stowed (m <sup>3</sup> )	Mass (kg)	Specific Power (W/kg)	BOL Power @ 1 AU (kW)
156.25	~1.14	167.59	273.14	45.776

Table 2. Initial Battery Specifications

Battery (Li-Ion)	Size (m <sup>3</sup> )	Mass (kg)	Capacity (Wh)	Cell Configuration
SAFT VL51ES	0.06892	80.4	10,452	6p10s



# Max Power per Phase

Phase	Maximum Power Draw (W)	Distance from the Sun (AU)	Max Solar Panel Power (W)	Max Angle from sun, $\theta$ ( $^{\circ}$ )
2	753	1	34835	88
3	519	1	34835	88
4	602	5	1393	64
5	753	5	1393	65
6	887	7	710	0
7	514	7	710	36
SF	304	1-7	> 710	< 65

# Phase 2: Power Budget Summary

Subphases	Duration (min)	AU	Power Draw (W)	ROSAS Deployed	Solar Power (W)	Initial Battery Power (W-hr)	Final Battery Power (W-hr)
2.1	1	1	316	0	0	8324	8319
2.2	30	1	696	0	0	8319	7971
2.3	5	1	543	0	0	7971	7926
2.4	5	1	583	2	34836	7926	8324
2.5	120	1	503	2	34836	8324	8324
2.6	60	1	753	2	34836	8324	8324
2.7	1051200	1	503	2	34836	8324	8324
2.8	60	1	753	2	34836	8324	8324

# Phase 3: Power Budget Summary

Subphases	Duration (min)	AU	Power Draw (W)	ROSAS Deployed	Solar Power (W)	Initial Battery Power (W-hr)	Final Battery Power (W-hr)
<b>3.1</b>	10	1	503	2	34836	8324	8324
<b>3.2</b>	5256000	1	519	2	34836	8324	8324
<b>3.3</b>	30	1	519	2	34836	8324	8324



# Phase 4: Power Budget Summary

Subphases	Duration (min)	AU	Power Draw (W)	ROSAS Deployed	Solar Power (W)	Initial Battery Power (W-hr)	Final Battery Power (W-hr)
4.1	60	1	603	2	34836	8324	8324
4.2	60	3	603	2	3871	8324	8324
4.3	259200	3	503	2	3871	8324	8324
4.4	60	5	753	2	1394	8324	8324
4.5	60	5	519	2	1394	8324	8324
4.6	30	5	519	2	1394	8324	8324
4.7	60	5	531	2	1394	8324	8324

# Phase 5: Power Budget Summary

Subphases	Duration (min)	AU	Power Draw (W)	ROSAS Deployed	Solar Power (W)	Initial Battery Power (W-hr)	Final Battery Power (W-hr)
5.1	3	5	530	2	1393	8324	8324
5.2	5	5	503	2	1393	8324	8324
5.3	5	5	503	2	1393	8324	8324

# Phase 6: Power Budget Summary

Subphases	Duration (min)	AU	Power Draw (W)	ROSAS Deployed	Solar Power (W)	Initial Battery Power (W-hr)	Final Battery Power (W-hr)
6.1	10	7	503	2	710	8324	8324
6.2	480	7	887	2	710	8324	6917
6.3	960	7	503	2	710	6917	8324

# Phase 7: Power Budget Summary

Subphases	Duration (min)	AU	Power Draw (W)	ROSAS Deployed	Solar Power (W)	Initial Battery Power (W-hr)	Final Battery Power (W-hr)
7.1	7200	7	514	2	710	8324	8324

# Fault Mode: Power Budget Summary

Duration (min)	AU	Power Draw (W)	ROSAS Deployed	Solar Power (W)	Initial Battery Power (W-hr)	Final Battery Power (W-hr)
14400	7	304	2	710	8324	8324

Detumble

## Table 2.0 Power Table

Phase	2	3	4	5	6	7	FM
<b>Subsystem</b>	<b>Allocated Power (W)</b>						
<b>Thermal</b>	201	201	201	201	201	201	201
<b>ADCS</b>	186	186	186	186	186	186	38
<b>C&amp;DH</b>	100	100	100	100	100	100	0
<b>Comms</b>	16	16	16	16	400	16	16
<b>GNC</b>	0	0	12	12	12	12	0
<b>Structures</b>	164	84	84	84	84	0	0
<b>Propulsion</b>	200	0	200	0	0	0	0
<b>Payload</b>	0	25	25	25	0	0	0
<b>Total:</b>	867	612	824	624	983	515	255

---

# Sci Tech

---



**Matthew Jones**

**Lauren Fukaye**

**Michael Limotta**

# Sci Tech Risks

- Given that there are uncertainties about the backscatter power there is a possibility of the shape model not considering the measurement uncertainty or measurement precision in the backscatter power adversely impacting the post-processing necessary to generate the shape model, which can result in the shape model not being able to be known to the required resolution if the backscatter power is not able to be measured with a high enough precision and low enough certainty.
- Given that there are unknowns about the ISO's shape there is a possibility of the ISO not being spherical as predicted adversely impacting the post-processing of the data and the shape model, which can result in an ISO shape which could reduce the coverage that we could get on our model, leading to an unmet requirement.
- Given that the shape model resolution may decrease due to time delay measurement uncertainty there is a possibility of the model predicting higher resolutions than are possible adversely impacting the post-processing necessary to generate the shape model, which can result in the final shape model not meeting the resolution requirement.



# SAR Shape Model – Governing Equations

Doppler Equation:

$$\nu = -\frac{2}{\lambda} \left( \frac{dR}{dt} \right)$$

- R is the distance from the radar to a point on the ISO surface
- $dR/dt$  is the slant range velocity between the radar and a point on the ISO surface
- $\lambda$  is the radar signal wavelength
- $c$  is the speed of light

Delay Equation:

$$\tau = 2R/c$$

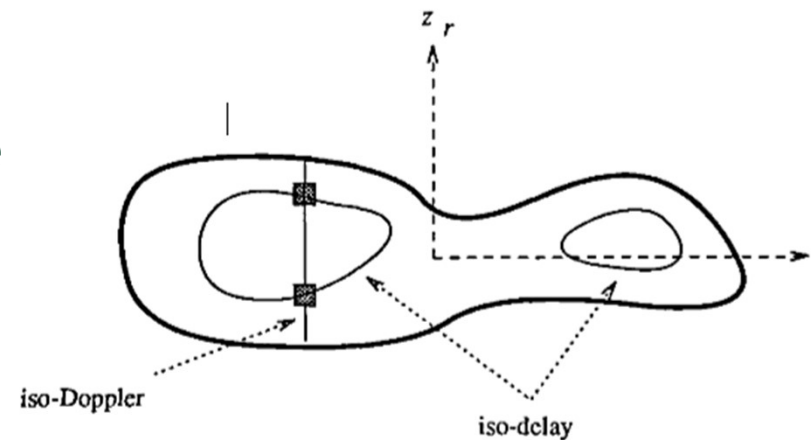

Equations and Image From: Scott Hudson (1994) Three-dimensional reconstruction of asteroids from radar observations, Remote Sensing Reviews, 8:1-3, 195-203, DOI: [10.1080/02757259309532195](https://doi.org/10.1080/02757259309532195)

Model  
Assumptions

# SAR Shape Model – General Process

- Choose a point on the ISO surface
- Calculate the expected delay and doppler values for a signal that came from that point
- Move to points 10 meters away in two specified directions (e.g., north and west)
- Calculate the expected delay and doppler values for a signal that came from those points
- Take the difference between the original delay and doppler values and those of the nearby points
- Calculate the total ISO surface area from which the data returns (assumed 50%)
- If the uncertainty in the doppler measurements is larger than the difference in doppler between either of the two points, then the point is unable to be discerned to the +/- 10 meter resolution. The associated ISO surface area is subtracted from the total area represented in the return signal.
- Given the measurement uncertainty, if the radar is unable to discern the difference in doppler required to maintain the +/- 10 meter resolution, the associated surface area is subtracted from the total area represented in the return signal.
- The remaining ISO surface area can be discerned to +/- 10 meters

Model  
Assumptions

---

# Launch Services

---

Ryan Antoff

Chris Wang

# Electrical Connections to GSE on Launch Pad

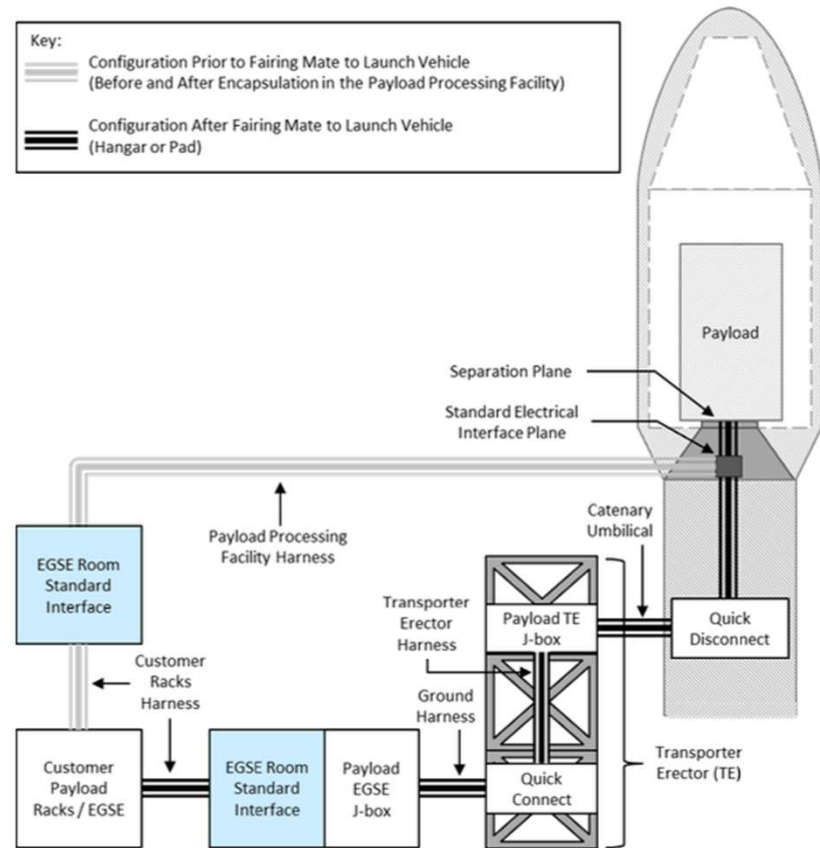
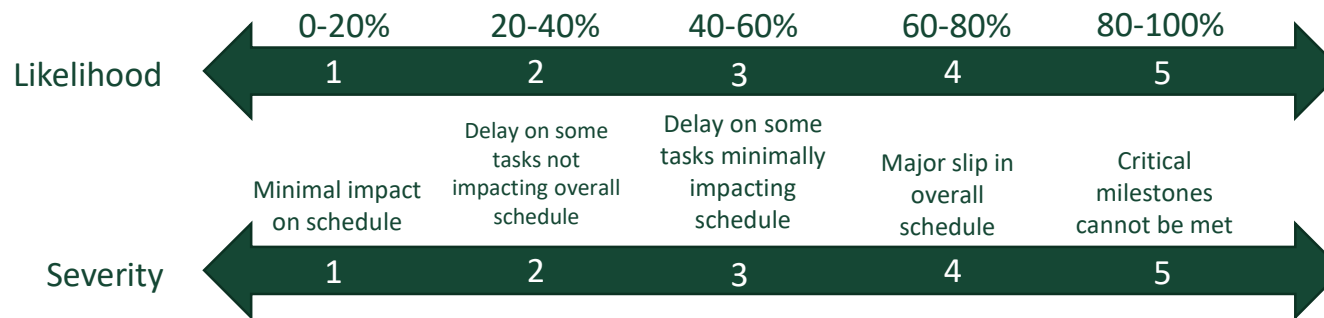

Figure 5-2: On-pad electrical interfaces

# Pre-Launch Risks – Fueling

Given that...	There is a possibility of...	Which can result in...	Likelihood (out of 5)	Severity (out of 5)	Sub team
The 3rd party fueling is unable to provide their services	No propellant being loaded into the spacecraft immediately before launch	A significant delay in the launch and lead to a delayed reaction readiness date	2	1 or 4	Launch Services



---

# Customer Clarifications

---

TEMPLATE (WRITE IN ALL CAPS)

# Customer Clarifications

## Assumptions Clarified with Customer:

- The number of follow up trajectory updates and timeliness needed to keep the ISO uncertainty low will be defined by our ephemeris uncertainty team, but **updates may be provided by the customer.**
- Our team is required to design the function and performance of ground system but may utilize existing ground assets that match the mission needs, e.g. DSN
- A space-base system will react to incoming ISOs determined by the customer:
  - ISO determination will be based on orbital analysis of detected ISOs which fall within a predefined on-board dV value and other factors deemed most important by our team upon further research.
  - Our team will define these values based on orbit models that assume a constant, average rate of **1 ISO detection per year for a 20-year period**, and with ISO orbital parameters given by the solicitation.

---

# Schedule Breakdown

---

TEMPLATE (WRITE IN ALL CAPS)



# System Realization Schedule

Main Slide

Phase C: Final Design & Fabrication	1199 days
Final Design	113 days
Technology Research & Development	113 days
Critical Design Review	5 days
Develop Plans & Procedures	857 days
Development of the Instrument Housing Module (IHM)	641 days
COSMIC A IHM Realization	618 days
COSMIC B IHC Realization	585 days
Development of the Spacecraft Bus	277 days
Development of the Ground System	110 days
Phase C Margin	166 days
Systems Integration Review	5 days
Phase D: System Assembly, Integration & Test, Launch & Checkout	1021 days



Development of the Instrument Housing Module (IHM)	641 days
COSMIC A IHM Realization	618 days
IHM Structure Subsystem Realization	80 days
Power Subsystem Realization	56 days
Guidance, Navigation, and Control (GNC) Subsystem Realization	53 days
Attitude Determination and Control (ADCS) Subsystem Realization	82 days
Payload Subsystem Realization	111 days
Communication Subsystem Realization	93 days
Command and Data Handling (C&DH) Subsystem Realization	60 days
Thermal Subsystem Realization	23 days
COSMIC A IHM Transition 1	14 days
COSMIC A IHM Functional Test	49 days
COSMIC A IHM Transition 2	14 days
COSMIC A IHM Environmental Testing	49 days
COSMIC A IHM Transition 3	14 days
COSMIC B IHC Realization	585 days