

UNCLASSIFIED

AD NUMBER: ADB216503

LIMITATION CHANGES

TO:

Approved for public release; distribution is unlimited.

FROM:

Distribution authorized to US Government Agencies only; Proprietary Information; 20 Nov 1996. Other requests shall be referred to Aeronautical Systems Division, ATTN: ASD/XR, Wright-Patterson AFB, OH 45433.

AUTHORITY

AFLCMC memo dtd 30 Oct 2017



**DEPARTMENT OF THE AIR FORCE**  
AIR FORCE LIFE CYCLE MANAGEMENT CENTER  
WRIGHT-PATTERSON AIR FORCE BASE OHIO

30 October 2017

MEMORANDUM FOR DTIC/INFOSEC  
ATTENTION: Mr. Robert Stokes

FROM: AFLCMC/XZ  
2240 B Street, Bldg 11, Rm B58  
Wright-Patterson AFB OH 45433-7104

SUBJECT: Change of Distribution Statement for ADB216503

1. The Aeronautical Systems Division (ASD/XR) is now the Program Development & Integration Directorate (AFLCMC/XZ).
2. As the Office of Primary Responsibility (OPR) for the "Final Report on Boeing Transatmospheric Vehicle (TAV) Concept Definition (Phase I)" (DTIC AD Number ADB216503), we request that the distribution code be changed from B to A.
3. The report has gone through government technical review, government legal review, contractor legal review, and public affairs review.
4. If you have any questions regarding this request, please contact Capt Nihar Shah ([nihar.shah.4@is.af.mil](mailto:nihar.shah.4@is.af.mil), 937-904-4505).

A handwritten signature in black ink, appearing to read "Richard B. Gibson".

RICHARD B. GIBSON, NH-04, USAF  
Deputy Director, Program Development &  
Integration Directorate

Attachments:

1. 88 ABW PA Approval - Case Number 88ABW-2017-5347, 30 Oct 2017
2. Boeing Legal Response, 6 Sep 2017
3. FOIA Request OPR Memo, 15 Sep 2017

BOEING PROPRIETARY

VOLUME V

DISTRIBUTION STATEMENT B: Distribution authorized to U.S. Government agencies only. **PROPRIETARY INFORMATION**. This document shall be referred to as **20 NOV 1996**

FINAL REPORT

ON

BOEING  
TRANSATMOSPHERIC VEHICLE (TAV)  
CONCEPTS DEFINITION  
(PHASE I)

to

Battelle Columbus Laboratories  
(Subcontract No. A-3089(6697)-288)

and

Aeronautical Systems Division (ASD/XR)  
Wright-Patterson AFB, Ohio 45433  
(USAF Contract No. F33615-83-C-0132, Task 6)

December 22, 1983  
Report Number D180-27669-4

RESTRICTED DISTRIBUTION

NOTICE

This document contains data and information that are considered company proprietary by our subcontractors and shall not be disclosed outside the U.S. government.

Prepared By

Boeing Military Airplane Company  
Seattle, Washington  
98124

DTIC QUALITY INSPECTED 1

19961119 062

# DISCLAIMER NOTICE



**THIS DOCUMENT IS BEST QUALITY AVAILABLE. THE COPY FURNISHED TO DTIC CONTAINED A SIGNIFICANT NUMBER OF PAGES WHICH DO NOT REPRODUCE LEGIBLY.**



BOEING PROPRIETARY

VOLUME V

BOEING  
TRANSATMOSPHERIC VEHICLE (TAV)  
CONCEPTS DEFINITION  
(PHASE I)

to

Battelle Columbus Laboratories  
Columbus, Ohio

(Subcontract No. A-3089(6697)-288)

and

Aeronautical Systems Division (ASD/XR)  
Wright-Patterson AFB, Ohio

(USAF Contract No. F33615-83-C-0132, Task 6)

December 22, 1983  
Report No. D180-27669-4

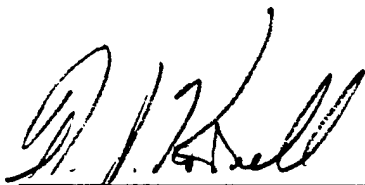

T. J. Kornell, TAV Study Leader  
Boeing Military Airplane Company  
Developmental Center  
Mail Stop 43-42  
P. O. Box 3707  
Seattle, Washington 98124

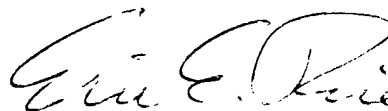

E. E. Rice, Manager  
TAV Concept Development and Evaluation  
Battelle Columbus Laboratories  
505 King Avenue  
Columbus, Ohio 43201

Prepared By

Boeing Military Airplane Company  
Seattle, Washington  
98124

## TABLE OF CONTENTS

	<u>Page</u>
1.0 INTRODUCTION	iv
2.0 EXECUTIVE SUMMARY	1
2.1 Two-Stage Fully Reusable Launch System, Concept B-1	1
2.1 Sortie Vehicle, Concept B-2	15
2.3 Reusable Aerodynamic Space Vehicle (RASV), Concept B-3	43
3.0 CONCEPT DEVELOPMENT AND ANALYSIS	64
3.1 Two-Stage Fully Reusable Launch System, Concept B-1	65
3.1.1 Detailed Concept Definition	65
3.1.2 Concept Analysis and Trade Studies	109
3.1.3 Cost Analysis	166
3.1.4 Technology Risk Assessment	183
3.1.5 Requirements Compliance	183
3.1.6 Conclusions	183
3.2 Sortie Vehicle, Concept B-2	190
3.2.1 Detailed Concept Definition	191
3.2.2 Concept Analysis and Trade Studies	231
3.2.3 Cost Analysis	245
3.2.4 Technology Risk Assessment	258
3.2.5 Requirements Compliance	260
3.2.6 Conclusions	264
3.3 Reusable Aerodynamic Space Vehicle (RASV), Concept B-3	270
3.3.1 Detailed Concept Definition	271
3.3.2 Concept Analysis and Trade Studies	289
3.3.3 Cost Analysis	320
3.3.4 Technology Risk Assessment	361
3.3.5 Requirements Compliance	368
3.3.6 Conclusions	371
4.0 RECOMMENDATIONS	375
4.1 Effectiveness Evaluation Tasks	375
4.2 Recommendations for Phase II	392
APPENDICES	402
Appendix A - TAV Concept Development & Evaluation Subcontractor Statement of Work	403
Appendix B - POST Optimized Performance Trajectory for Concept B-1	409
Appendix C - POST Optimized Performance Trajectory for Concept B-2	429
Appendix D - POST Optimized Performance Trajectory for Concept B-3	441

# 1.0 Introduction

The study effort reported in this document was initiated under Subcontract Number A-3089(6697)-288 to Battelle Columbus Laboratories on May 5, 1983, and completed on December 9, 1983. The effort is defined by the statement of work shown in Appendix A of this document.

The study requested The Boeing Company to describe two or more Transatmospheric Vehicle (TAV) concepts that could provide 5,000 lb to 30,000 lb in low Earth orbit utilizing horizontal takeoff (HTO). A brief list of system requirements and goals were defined in the statement of work. Possible missions and threats for the TAV were developed and updated by Battelle throughout the contract. The last update was provided on August 15, 1983, by Battelle document number D83-02434 (revised 7/29/83, Secret). "Final Requirements for a Transatmospheric Vehicle Concept Development."

The Boeing Company has been continuously involved in recoverable booster studies and developing the technology for these systems from 1953 through the present. Our early efforts allowed us to win the Air Force competition for Dynasoar, the first recoverable space vehicle. This work led to the Boeing participation in the Saturn Program as well as numerous early recoverable booster studies. Boeing was deeply involved in the concept definition phase of the Space Shuttle Program and has maintained an IR&D technology program on reusable aerodynamic space vehicles for the last ten years. Using this background, we believe that the three concepts: (1) two-stage HTO fully reusable system, (2) sortie vehicle, and (3) reusable aerodynamic space vehicle (RASV) meet the intent of the TAV requirements/missions (to different levels of capability) and could provide the Air Force with a revolutionary operational weapon system.

The contents of this document as shown on the adjacent page has been structured for reader clarity. The approach was to provide to Battelle presentation-grade viewfoils on one page and a technical description of the viewfoil on the facing page. The key sections of the document dealing with the vehicle concepts and a brief description of the sections contents are as follows:

- 2.0 Executive Summary - Brief Overview of All Three Concepts
- 3.1 Concept B-1 - Detailed Description of Two-Stage HTO Concept
- 3.2 Concept B-2 - Detailed Description of Sortie Vehicle Concept
- 3.3 Concept B-3 - Detailed Description of RASV Concept and  
Appendices B, C, and D - Optimized B-1, B-2, and B-3 Vehicle Trajectories

## TRANSATMOSPHERIC CORPORATE STRUCTURE

## o STUDY ORGANIZATION

All key Boeing Company organizations are committed to supporting the Air Force's desire to obtain a good concept definition and ultimately develop a TAV system. The Boeing Military Airplane Company is chartered to study Concept B-1 "Two Stage HTO Launch System" under direction of T. J. Kornell. Boeing Aerospace Company is studying Concept B-2 "Air Launched Sortie System" with Dana Andrews acting as principal engineer, and Concept B-3 "Reusable Aerodynamic Space Vehicle" system is under the direction of Andrew Hepler. These concept studies have been supported by the Boeing Commercial Airplane Company experience under direction of D. L. Robinson.

The data presented in this document are a collaboration of the three principal Boeing companies. The effort represents The Boeing Company's background in recoverable boosters that covers thirty years of space studies.

# Transatmospheric Corporate Structure

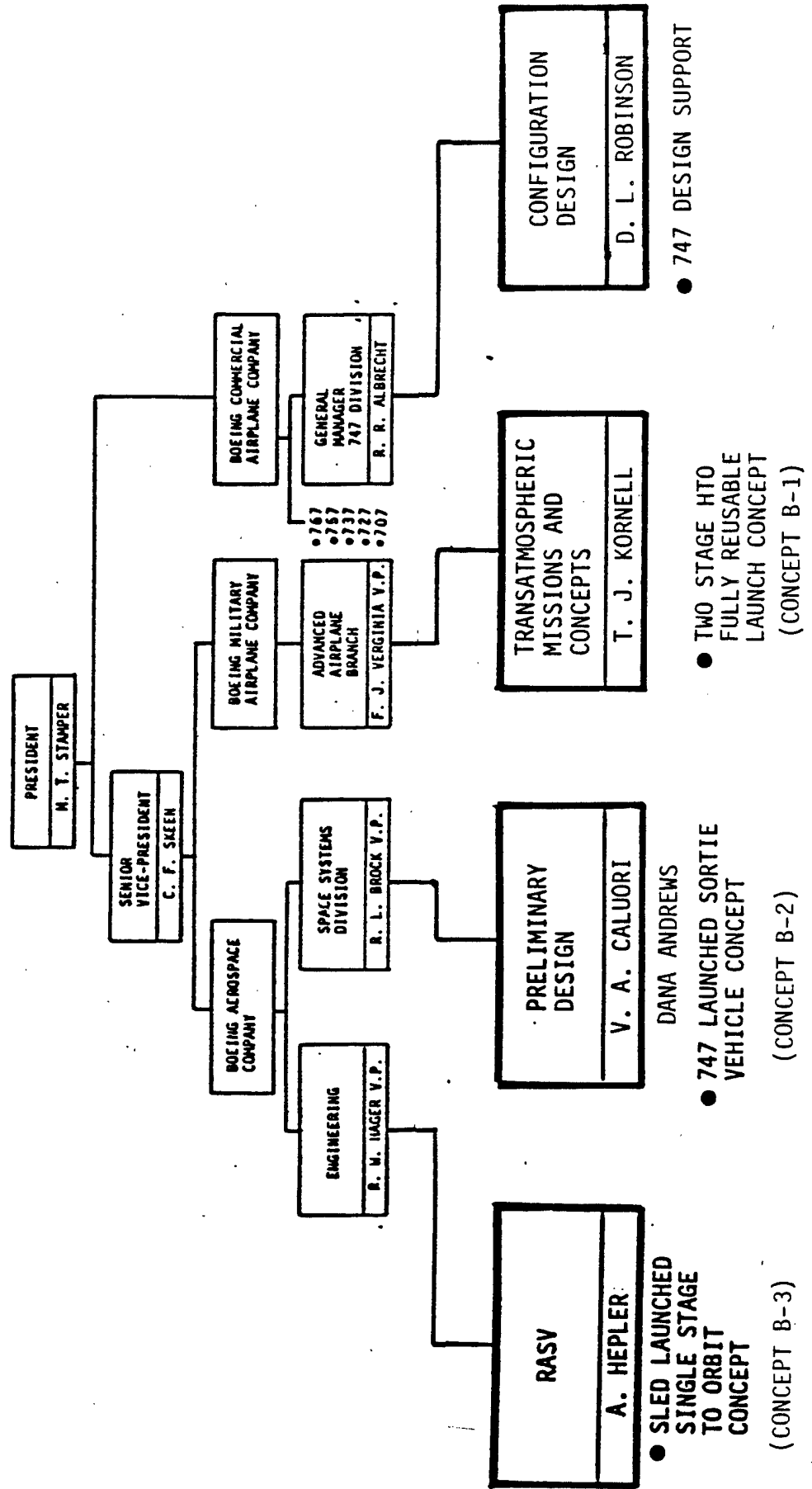

## TAV CONCEPT DEVELOPMENT AND EVALUATION STUDY

The Phase I contract effort was divided into three major tasks.

- Task A: Provide to Battelle a description of any Transatmospheric Vehicle candidates that Boeing has currently in work. In addition, Boeing was to provide a brief overview of any missions and/or threats that had been studied.
- Task B: The major contract effort was expended in studies to provide a more complete description of the concepts and sufficient analysis to show compliance with system requirements/goals.
- Task C: The effort was to recommend a follow-on program to be implemented in a Phase II contracted effort.

The statement of work requested three presentations (which were documented in D180-27669-1, -2 and -3) and a final report with a first draft provided 30 days in advance of the final (which were documented in D180-27669-4).

# TAV Concept Development and Evaluation Study

## PHASE I (DEFINITION OF TAV CONCEPTS)

### ● TASK A

- PREPARE MISSION BRIEFING
- PREPARE TAV CONCEPT BRIEFING / DOCUMENTATION D180-27669-1

FIRST BRIEFING  
COMPLETED  
MAY, 24, 1983

### ● TASK B (FOR EACH CONCEPT)

- DESCRIBE DESIGN & SIZING CRITERIA
- PROVIDE PERFORMANCE DATA
- PROVIDE GROUP WEIGHT STATEMENT
- PROVIDE 3-VIEW EXTERNAL ARRANGEMENT DWG.
- PROVIDE AN INBOARD PROFILE
- PROVIDE A STRUCTURAL DIAGRAM
- PROVIDE AN INSTALLATION DWG FOR 2 STG. SYS.
- DESCRIBE LOGISTICS & SUPPORT CAPABILITIES
- DESCRIBE VEHICLE OBSERVABLE
- PROVIDE DEVEL., INVESTMENT, O&M ROM COSTS
- RANK ORDER CANDIDATE CONCEPTS
- MIDTERM BRIEFING & DOCUMENT D180-27669-2

MIDTERM BRIEFING  
COMPLETED  
JULY 14, 1983

FINAL BRIEFING  
COMPLETED  
AUGUST 22, 1983

DRAFT REPORT  
COMPLETED  
AUGUST 31, 1983

### ● TASK C

- PREPARE PHASE II PLAN
- FINAL BRIEFING & DOCUMENT D180-27669-3
- DRAFT FINAL REPORT } D180-27669-4
- FINAL REPORT

FINAL BRIEFING  
COMPLETED  
AUGUST 22, 1983

FINAL REPORT  
COMPLETED  
DECEMBER 22, 1983

## BATTELLE STUDY SCHEDULE

The contracted effort was scheduled as shown on the Battelle study schedule. The key milestones were all met as requested.

- o The first presentation was two weeks after contract award in Seattle, Washington on May 24, 1983.
- o The second milestone was a midterm presentation conducted on July 14, 1983 at Battelle's Columbus Laboratories in Columbus, Ohio.
- o The third milestone was the final presentation delivered on August 22, 1983 in Seattle, Washington.
- o The fourth milestone was completed with the delivery and receipt of this document.
- o The last milestone was completed on December 22, 1983 with the submittal of the final document D180-27669-4.

The final document provided all the key charts used in the presentations with facing page writeups that expand the data content on the charts.



# Battelle Study Schedule

1983

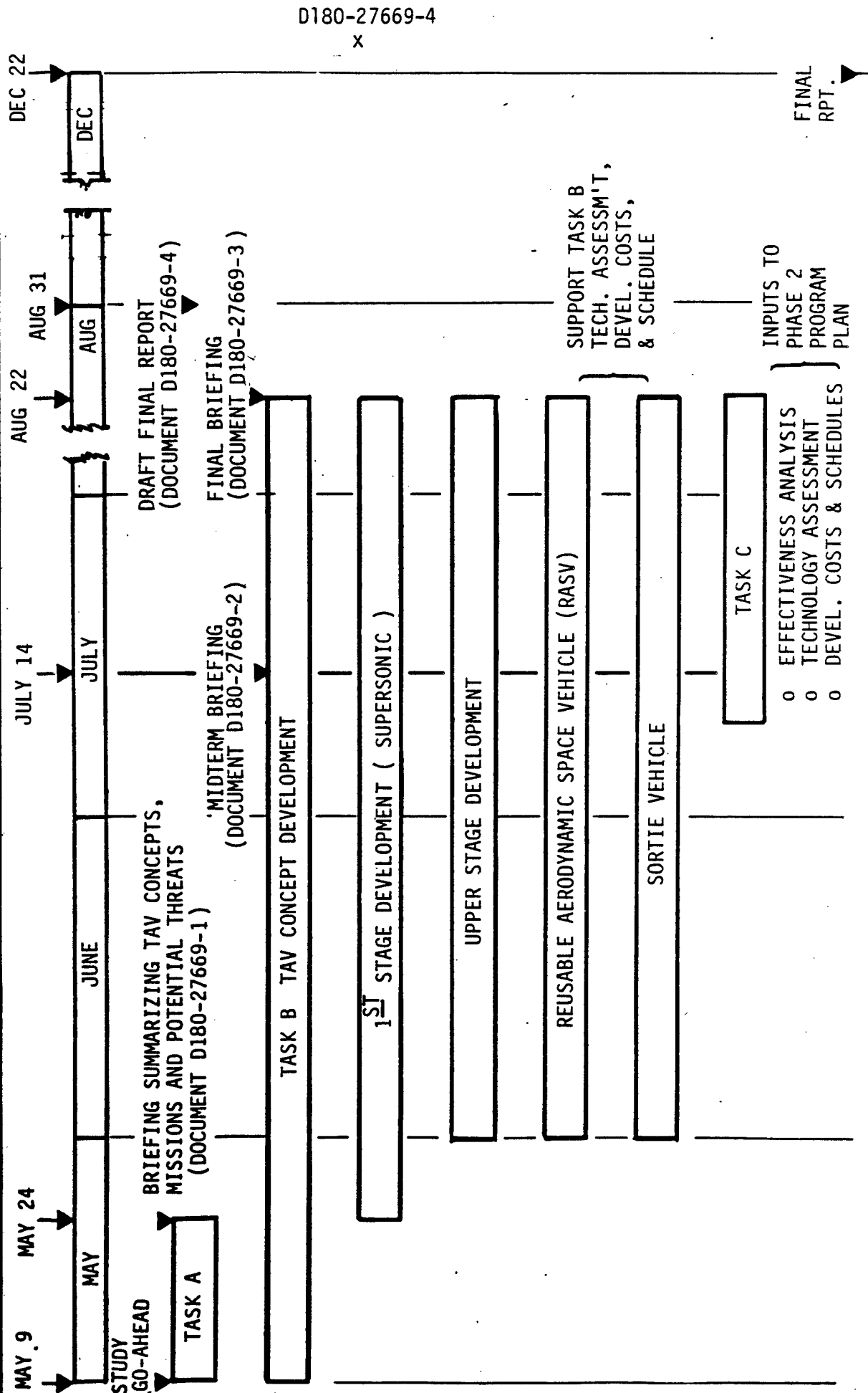

### TRANSATMOSPHERIC CONCEPTS

The Boeing Company has elected to submit three Transatmospheric Vehicle (TAV) concepts. All concepts meet the intent of the TAV system requirements with different capabilities. The level of definition of mission/payload needs and requirement priorities makes the task of concept elimination very judgmental. For this reason Boeing has provided all the data requested to Battelle and the USAF to support any concept reduction effort.

The three concepts submitted are shown. All are horizontal takeoff systems that were conceived with military operational readiness as a prime overall requirement. Each concept achieves survivability by rapid dispersion airfield to airfield and all are manned. Concepts B-1 and B-3 are considered longer term development systems and use 1990 technology forecasts. Concept B-2 is based on use of upgraded Shuttle technology with the use of an existing 747 as the first stage.

BOEING PROPRIETARY

# Transatmospheric Concepts

HORIZONTAL TAKEOFF

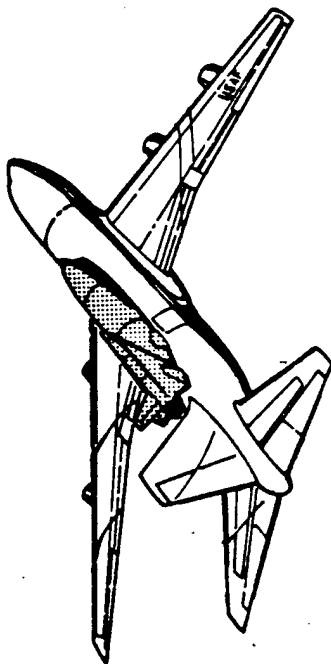

● AIR LAUNCHED SORTIE VEHICLE  
CONCEPT B-2

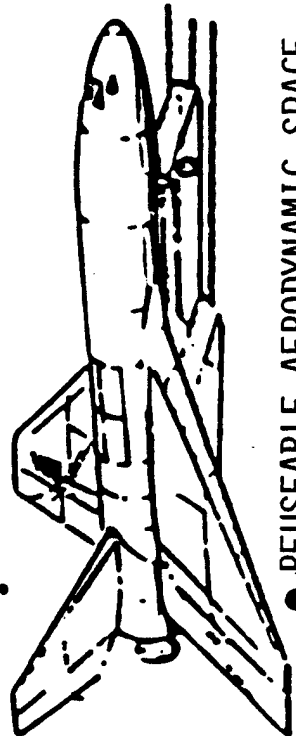

● REUSEABLE AERODYNAMIC SPACE  
VEHICLE (RASV)  
CONCEPT B-3

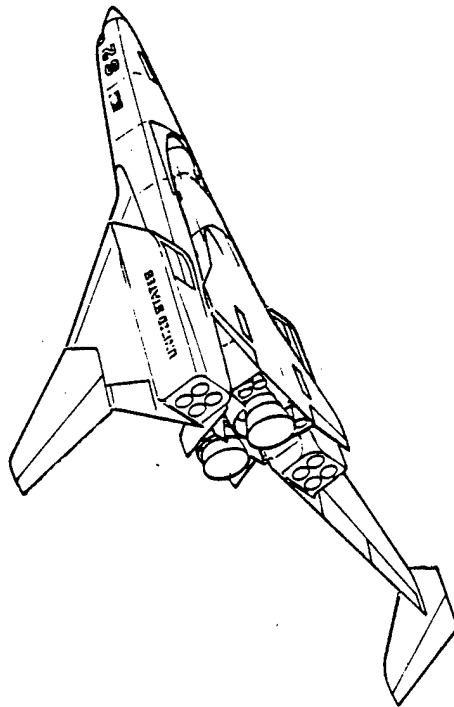

● TWO STAGE HTO FULLY REUSEABLE SYSTEM  
CONCEPT B-1

**2.1 Two Stage Fully Reusable Launch System,  
Concept B-1**

**2.0 Executive Summary**

## BOEING PROPRIETARY

TWO-STAGE FULLY REUSABLE LAUNCH SYSTEM CONCEPT  
(MODEL 986-111 CONCEPT B-1)

The flight view shown on the facing page depicts the staging maneuver of the two-stage launch system. This maneuver occurs at an altitude of 117,500 ft, at a staging velocity of 3000/s, and a flightpath angle of 32°. The prime booster performs a conventional horizontal takeoff and landing using advanced derivative airbreathing engines and JP-4 fuel. Both booster and orbiter vehicles utilize LO<sub>2</sub>/LH<sub>2</sub> propellants during the rocket boost phase and has a propellant crossfeed system from booster to orbiter to ensure that the orbiter vehicle propellant tanks are completely filled at stage separation. The vehicle is operated by a two-man crew in a shirtsleeve environment, has all-weather capability, and is capable of operation from all SAC bases and major commercial airports if required on a limited basis.

A prime orbiter feature is the "hot metal structure" concept which requires fairly low reentry planform loadings of 22 to 27 lb/ft<sup>2</sup> which eliminates the requirement for replaceable thermal tiles.

A 11-ft dia x 21-ft-long payload bay designed for a payload density of 10 lb/ft<sup>3</sup> will have good adaptability to a variety of payloads. Payloads ranging from 20,000 to 30,000 lb are planned, depending on launch azimuth and launch direction. Both the booster and orbiter use identical SSME rocket engines expanded 150 to 1.

BOEING PROPRIETARY

# Two Stage Fully Reusable Launch System Concept

CONCEPT B-1

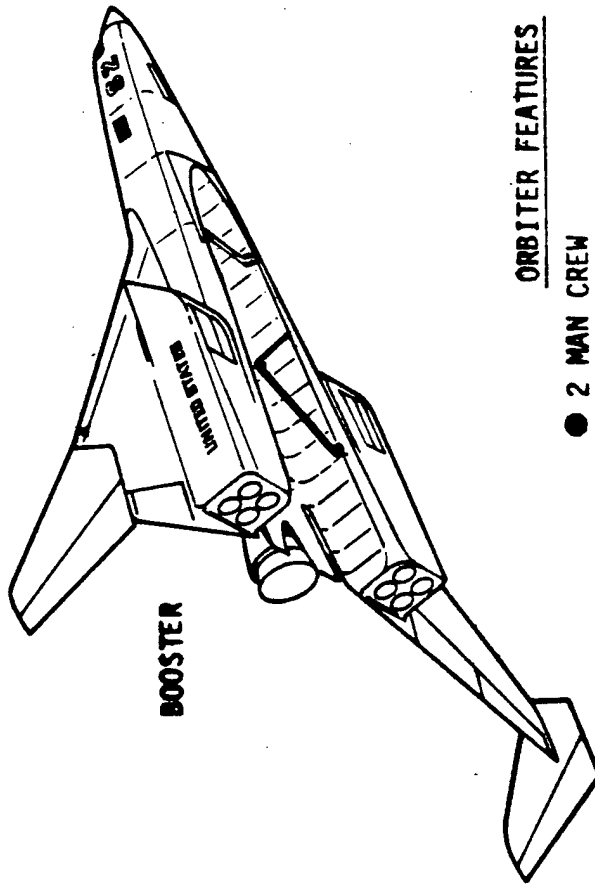

## BOOSTER FEATURES

- 2 MAN CREW
- 8 AIRBREATHER ENGINES
- ADVANCED COMPOSITE STRUCTURE
- CONVENTIONAL HTO & LANDING GEAR
- ALL WEATHER OPERATION
- COMPATIBLE WITH EXISTING MILITARY FACILITIES & LARGE CIVILIAN AIRFIELDS.
- POWERED LANDING WITH GO-AROUND
- ALTERNATE MISSION CAPABILITY
- FERRY ABILITY
- 1 SSME ENGINE (150 EXPANSION RATIO)

## ORBITER FEATURES

- 2 MAN CREW
- 1 SSME ENGINE (150 EXPANSION RATIO)
- HOT METAL STRUCTURE DESIGN
- 11' DIA x 21' LONG PAYLOAD BAY
- 30,000 LB. PAYLOAD CAPABILITY
- ALL WEATHER
- COMPATIBLE WITH MILITARY FACILITIES
- UNPOWERED LANDING
- FERRIED BY BOOSTER

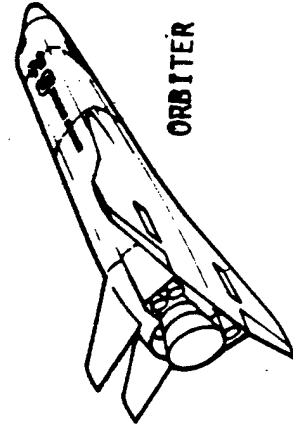

## TYPICAL FLIGHT PROFILE

Model 896-111 (Concept B-1) has a ground roll of 9700 ft at its maximum takeoff gross weight of 1,300,000 lbs. After climbing to 30,000 ft and  $M = .862$  under augmented airbreathing power, all rocket engines are ignited with the takeoff and climb taking 820.8 seconds. The vehicles proceed through a dual burn accelerated climb to the separation conditions under airbreathing and rocket thrust. During this initial boost the maximum dynamic pressure experienced is 1050 PSF and occurs at an altitude of 40,300 ft at  $M = 1.97$ . The vehicles separate at 117,500 ft,  $V = 3000$  FPS where the dynamic pressure is 65 PSF. The orbiter proceeds to the required injection conditions for the particular mission with its propellant tanks full at separation. After separation the booster is lofted to 156,000 ft by its own momentum, descends, turns to the required heading, and returns to the launch site or an alternate base through powered and gliding flight. At no time does the booster fly faster than  $M = 2.95$  and experiences mach numbers greater than 2.0 for only 212 seconds. This avoidance of a hostile flight environment enables the booster to be constructed of conventional materials without a thermal protection system. After completing the mission the orbiter enters the atmosphere with planform loadings between 23 and 27 PSF and is capable of 1400 NMI cross range. The orbiter can be turned around and ready for another mission in 12 hours.

# Typical Flight Profile

CONCEPT B-1

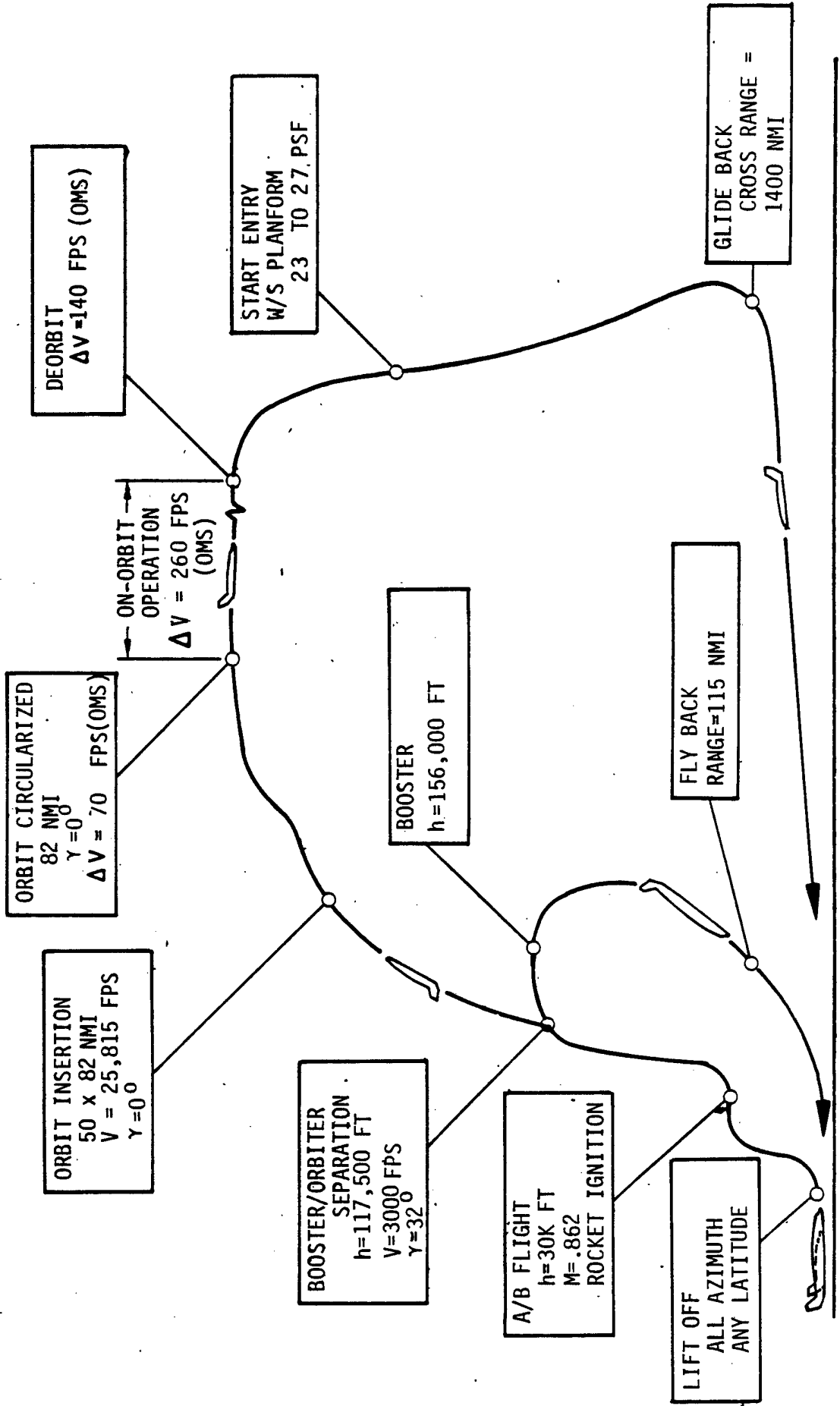



## BOEING PROPRIETARY

TWO-STAGE HTO LAUNCH SYSTEM CONCEPT B-1  
(MODEL 896-111)

The two-stage launch system concept shown on the opposite page has a launch weight of 1,300,000 lb. It is a fully reusable system and can place 20,000 lb of payload in a "once-around" polar orbit. Both the booster and orbiter are manned with a low staging velocity of 3000 ft/s. The system has all azimuth launch capability and a high payload to launch weight ratio ( $P/L/G_{LO} = 0.025$ ) for east launch missions from 32° latitude into "once-around" low circular orbits. The system is envisioned to be operational during the 1995-2000 time period.

The major issues at this time are (1) the potential development costs associated with two new launch vehicles being developed at the same time and (2) the requirement to meet the 12-hr turnaround as well as a 5-min launch after being put on alert status. The redeeming feature is that the first stage (booster) utilizes present day state-of-art construction.

# Two Stage HTO Launch System Concept B-1

MODEL 896-111

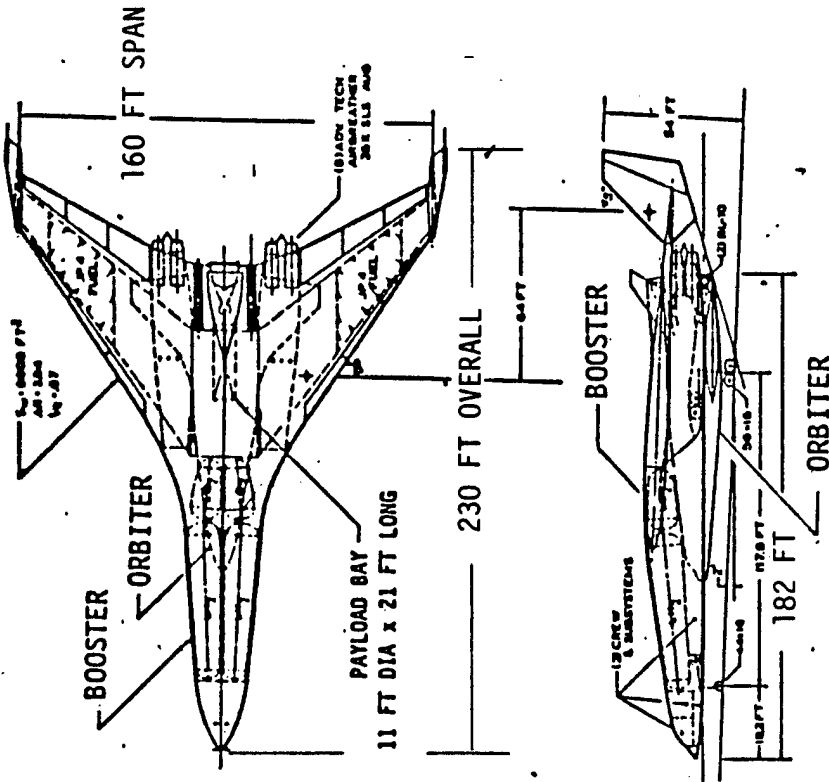

- **BENEFITS**
  - HIGH PAYLOAD TO GLOW WEIGHT CAPABILITY
  - 1ST STAGE STATE-OF-ART CONSTRUCTION
  - FULLY REUSABLE
  - PROVIDES AIRPORT-TO-AIRPORT SURVIVABILITY
  - POWERED FLYBACK AND FERRY CAPABILITY
  - ALL AZIMUTH LAUNCH
  - AVAILABLE IN 1995-2000 TIME PERIOD
- **ISSUE**
  - DEVELOPMENT COST FOR TWO STAGES
  - TURNAROUND AND ALERT READINESS RESPONSE TIME

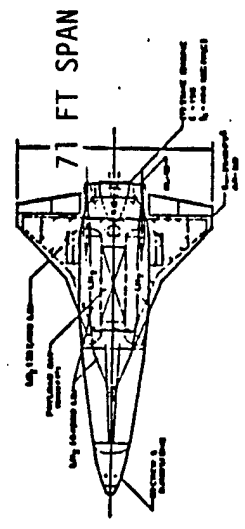
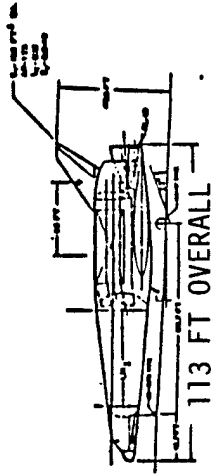
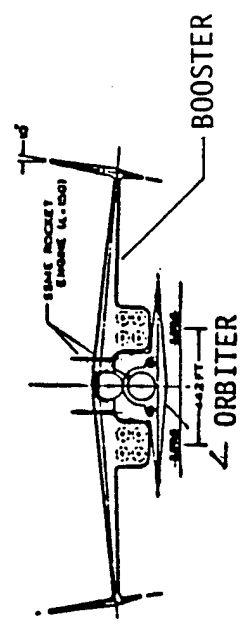

REUSABLE UPPER STAGE (ORBITER)

## BOEING PROPRIETARY

## TWO-STAGE HTO TAV BASING CONCEPT B-1

A simplified basing concept for Concept B-1 is indicated. This concept minimizes the requirement for the large amount of ground-support equipment normally associated with today's conventional vertical takeoff rocket launch systems. The proposed system utilizes a horizontal takeoff and landing mode. The Figure illustrates the overall ground-handling operation concept envisioned for mating the booster and orbiter prior to fueling and takeoff maneuver. The booster and orbiter are each towed to an "alert pad" and the vehicles aligned with their longitudinal centerlines coincident with each other. The orbiter is then towed forward into the booster body cavity and mechanically joined to the booster. The orbiter's landing gears are retracted and the booster/orbiter combination is towed to the L02/LH<sub>2</sub> servicing facility which is adjacent to the TAV pad to allow all cryogenic loading and replenishment to be controlled in one area.

After completion of the takeoff, climb, and separation, the booster would return to the base to be recycled for any necessary maintenance. The orbiter would be recycled following completion of its scheduled suborbital or orbital mission. The orbiter would be processed through a separate facility (not necessarily a separate building) to provide maintenance and payload integration, the latter being a significant activity. A separate monopropellant facility is visualized due to the hazardous nature of these systems. Future studies would identify benefits, costs, and risks of trading this separate complex against integrated systems and alternate propellants.

# Two Stage HTO TAV Basing Concept B-1

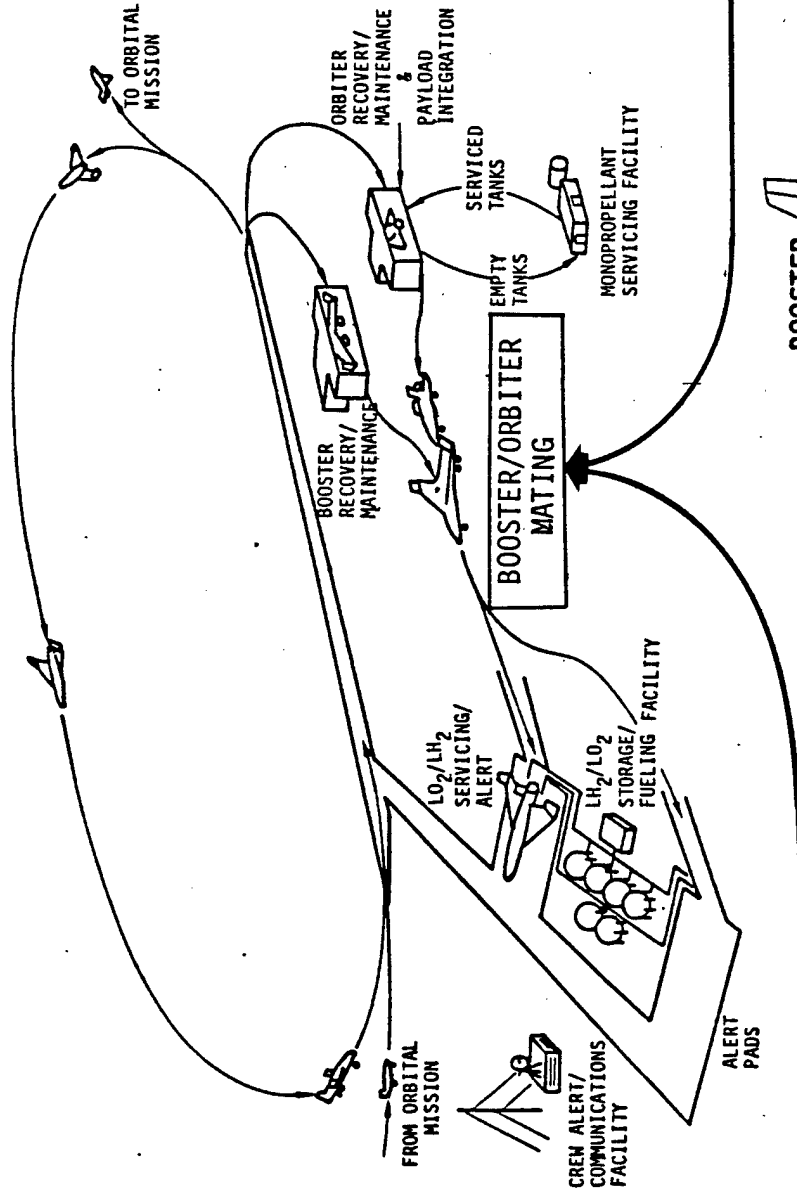

● BOOSTER-ORBITER MECHANICALLY MATED AND ORBITER LANDING GEARS RETRACTED

BOOSTER

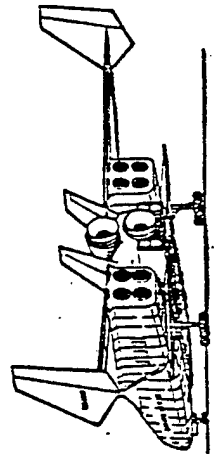

412-2000

BOOSTER

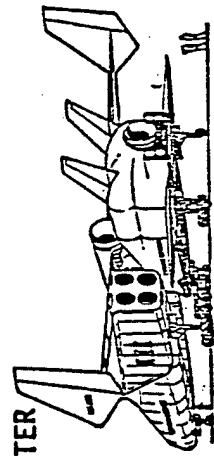

ORBITER

● BOOSTER-ORBITER INTERMEDIATE POSITION

BOOSTER

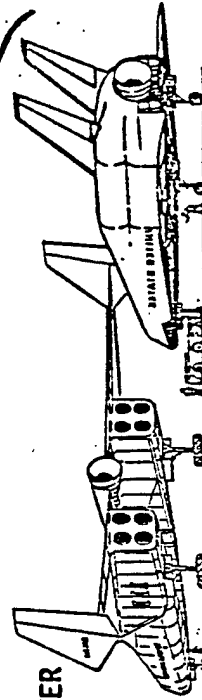

ORBITER

● BOOSTER-ORBITER INITIAL ALIGNMENT SEQUENCE

## TWO-STAGE LAUNCH SYSTEM PAYLOAD PERFORMANCE

Performance estimates are presented for Models 896-111 (Concept B-1), booster and hot structure orbiter, for the design goal and Missions A through D. Model 896-111 achieved the design goal of 20,000 lbs payload in a once-around polar suborbit. At 55° inclination, Mission C, Model 896-111 is capable of delivering 27,800 lbs once-around, and over 32,000 lbs at 32° inclination. The 500,000 ft circular orbit performance Missions A and B are shown utilizing a Hohmann transfer. Payload penalties of 3500 lbs and 3200 lbs are realized for 90° and 55° orbits, respectively, if orbit is achieved via direct ascent.

For Mission D, a nominal rendezvous  $\Delta V$  of 900 ft/s was used as a benchmark requirement. With this requirement set, Model 896-111 provides 10,000 lbs of payload and specialized docking equipment capability.

Additional performance estimates are presented for an alternate orbiter concept, Model 896-112. The -112 orbiter has been designed to be fully compatible with the -111 booster while employing the proven, shuttle-type reusable surface insulation. Model 896-112's performance is approximately 25 percent lower than -111 in delivering 16,050 lbs into a once-around polar orbit. The basic reason for the payload reduction is due to propellant volume limitations on the orbiter.

Further performance improvements have been realized through POST (Program to Optimize Simulated Trajectories) trajectory optimization. For Model 896-111, once-around payload performance increased from 32,150 lb to 34,500 lb for 32° inclination and from 20,000 lb to 23,000 lb for 90° inclinations. Comparable improvements are expected for Missions A through D. Details of the optimized trajectory performance including POST input and output files are contained in Appendix B.

BOEING PROPRIETARY

# Two-Stage Launch System Payload Performance

CONCEPT B-1 MODEL 896-111

**MISSION C:** Launch from 32° N latitude to a 500,000 ft altitude once-around (suborbital) 55° inclination, return-to-launch-site.

**MISSION D:** Launch from 28.5° N latitude to a 250 N mi circular 28.5° orbit, rendezvous, dock with Space Station, return-to-CONUS within several orbits (mission duration less than 24 hrs). Mission D is not to be mission driver, but a tradeoff vs. payload capability.

**MISSION A:** Launch from 32° N latitude to a 500,000 ft circular 55° orbit, return-to-launch-site after one orbit.

**MISSION B:** Launch from 32° N latitude to a 500,000 ft circular 90° orbit, return-to-launch-site after one orbit.

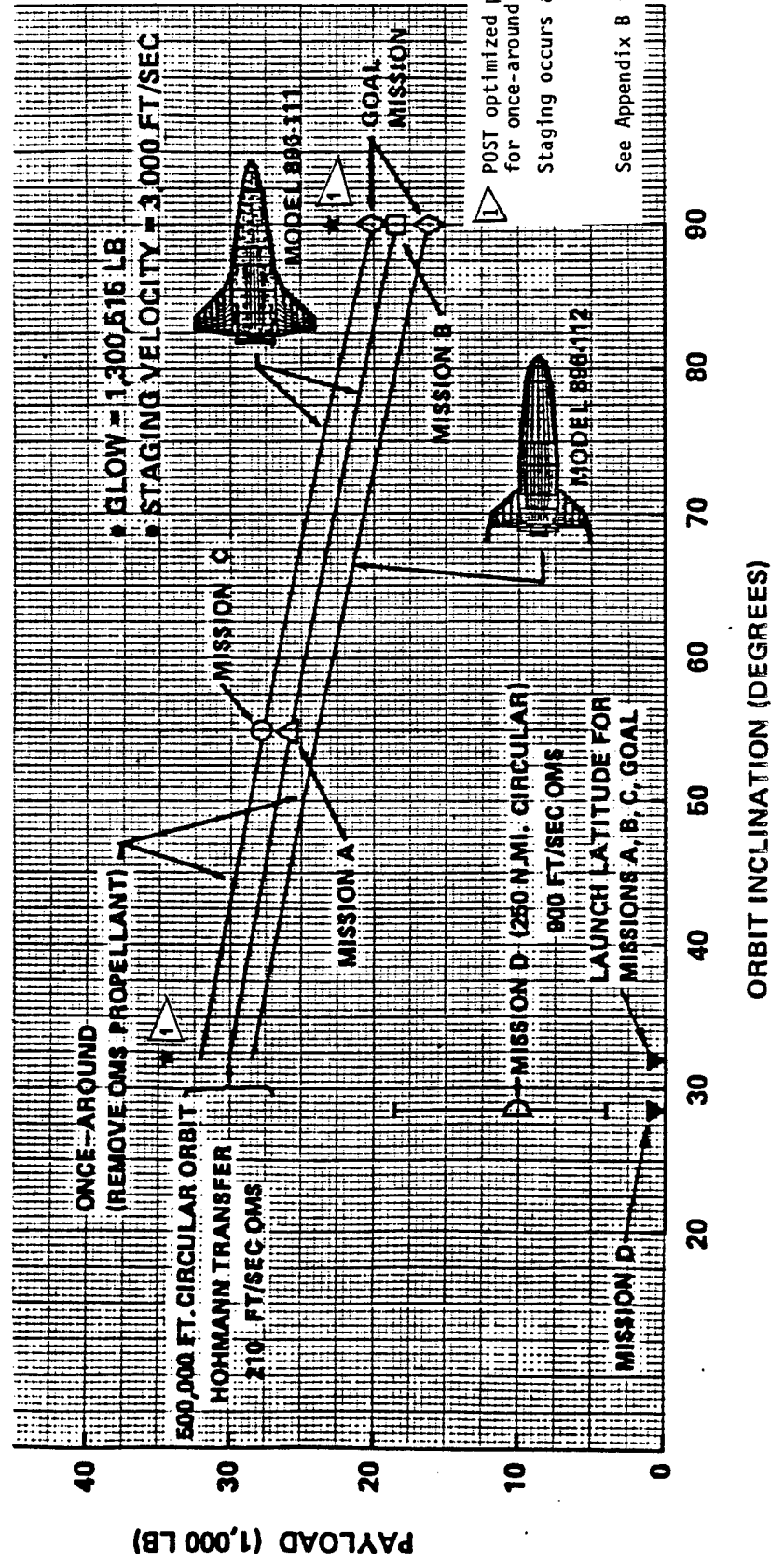

PRELIMINARY TAV PROGRAM SUMMARY

The Boeing Two-Stage Horizontal Takeoff Launch System (Concept B-1) was analyzed to review its ability to meet the "Final Requirements for a Transatmospheric Vehicle Concept Development" Battelle document number D83-02434 revised 7/29/83, Secret). The analysis indicates that Concept B-1 will meet the requirements and the conservative two-stage approach will be more tolerant to the normal development weight growth. The effort today did not reveal any concerns that would be considered fatal flaws.

A cursory review of a preliminary program schedule indicates that with a concept definition phase start in three years (approximately fiscal year 1986). Operational IOC is possible by calendar year 1995 (approximately 12 years from now).

A rough order-of-magnitude (ROM) cost was developed in 1983 dollars for three program phases as shown. The DDT&E phase costs were based on design and limited production of three vehicles, with flight test of two vehicles and a ground test of the third. The production cost including Government facilities cost was \$16.4B, and was based on 50 vehicle total buy at a production rate of 10 per year. The operation and support (O&S) cost of \$6.1B assumed ten (10) bases with ten (10) flights per year per base (one hundred (100) flights per year total) for twenty (20) years.

BOEING PROPRIETARY

# Preliminary TAV Program Summary (2-Stage)

MAJOR MILESTONES	SON APPROVAL		MENS APPROVAL		REQ'MT VALIDATION (SEC DEF)		PROGRAM GO-AHD (SEC DEF)		1ST FLT		PRODUCTION DECISION (SEC AF)		IOC	
	0	1	2	3	4	5	6	7	8	9	10	11		12
YEARS	0	1	2	3	4	5	6	7	8	9	10	11	12	13
F/Y	1983	1984	1985	1986	1987	1988	1989	1990	1991	1992	1993	1994	1995	1996

● SCHEDULE

● SONS/MENS PROCESSING

● CONCEPT DEFINITION

● CONCEPT VALIDATION

● FSED

● DESIGN/ANALYSIS

● TEST

● INITIAL PRODUCTION



2 FLIGHT VEHS.  
1 GRD VEH.



● COST (1983 DOLLARS)

- o DDT&E \$ 7.1B
  - o PRODUCTION \$16.4B
  - o O&S (20 YRS) \$ 6.1B
- \$ 29.7 B



THIS PAGE INTENTIONALLY LEFT BLANK

## **2.2 Sortie Vehicle, Concept B-2**

## AIR LAUNCHED SORTIE TAV (CONCEPT B-2)

The air-launched Sortie TAV (concept B-2) basic assumptions are outlined on the facing page. The baseline configuration is shown in isometric form on the following page.

The Boeing study effort on Air-Launched Sortie Vehicle (ALSV) was initiated under subcontract to Pratt & Whitney as a possible application for using and/or upgrading the RL-10 engine. The study was conducted from November 1981 through August 1982 under Air Force contract to Rocket Propulsion Laboratories and is reported in detail in three documents: AFRPL-TR-82-069, Volume I - Program Summary; Volume II - Technical Report; and Volume III - Appendix.

The data presented in this document drew extensively from the original study. Additional studies were conducted to evaluate the changes required to meet the "TAV Preliminary Requirements," specifically to determine the maximum reasonable payload in polar orbit (5000 pounds) in a manned configuration.

This concept emphasizes the use of existing technology to assure a high degree of creditability in achievement of performance, schedule, and cost estimates quoted.

BOEING PROPRIETARY

## Air Launched Sortie TAV (Concept B-2)

- BASELINE APPROACH—GO FOR LOW RISK, QUICKEST AND CHEAPEST DEVELOPMENT
- USE EXISTING ENGINES—SSME AND RL-10'S
  - SEVEN YEARS TO DEVELOP A NEW ENGINE
  - SAVES 0.5 TO 1.0 \$B OF DDT&E COST
- USE EXISTING SUBSYSTEMS TECHNOLOGY
- GRAPHITE EPOXY AND GRAPHITE POLYIMIDE STRUCTURE
- ADVANCED CERAMIC THERMAL PROTECTION
- STS AND IUS AVIONICS, RCS, EPS, ETC.
- REQUIRES 747 GROWTH DERIVATIVE (7000 FT<sup>2</sup> WING)
- NECESSARY TO MEET MANNED 5000 LB PAYLOAD CAPABILITY
- DESIGN AND TOOLING COSTS COULD BE OFFSET BY FREIGHTER/  
COMMERCIAL DERIVATIVE PRODUCTION

THE AIR LAUNCHED SORTIE APPROACH TRADES EARLY  
LOW-COST, LOW RISK DEVELOPMENT AGAINST HIGHER  
OPERATING COSTS

- KEY QUESTION IS BREAK-EVEN FLIGHTS PER VEHICLE

AIR LAUNCHED SORTIE/TAV

The figure shown on the opposite page depicts the launch sequence of the Air Launched Sortie Vehicle and the 747 Carrier Aircraft. All of the cryogenic propellants would be contained in vacuum jacketed tanks inside the carrier aircraft. The drop tank and the cryogenic propellant tanks in the Sortie Vehicle would be empty, but the Sortie Vehicle would have its discretionary mission equipment, storable propellants, and other consumables on board. After takeoff, the combination climbs to approximately 25,000 ft, at which time cooldown and cryogenic propellant transfer to the drop tanks and Sortie Vehicle is started.

Release of the Sortie Vehicle occurs at approximately 25,000 ft and approximately 20-deg flight path angle under approximately  $-.04\text{-g}$  normal acceleration, which ensures positive separation. The thrust from the two outboard RL10's exceeds the drag of the Sortie Vehicle/drop tank combination at this altitude, so propellants remain settled in the engines and their inlet feedlines. The remaining SSME rocket engine is started as soon as the Sortie Vehicle has cleared the 747's tail. The drop tank is emptied after 277 sec at approximately 305,000 ft and 21,600 ft/s. It is then discarded and burns up on reentry. The Sortie Vehicle achieves orbital velocity using propellants contained in its internal tanks.

The Sortie Vehicle then performs its mission. This will probably be of only one or two orbits, so the losses in cryogenic propellants contained in the vehicle's internal tanks will be minimal. These propellants will be used for the vehicle's deorbit burn and, if desired, could also be used for other propulsive maneuvers. Finally, after completing its mission and deorbit burn, the Sortie Vehicle reenters and lands at an Air Force Base with a 10,000-ft runway. Normally this will probably be the same base at which the 747 launch aircraft had landed.

BOEING PROPRIETARY

# Air Launch Sortie/TAV (Concept B-2)

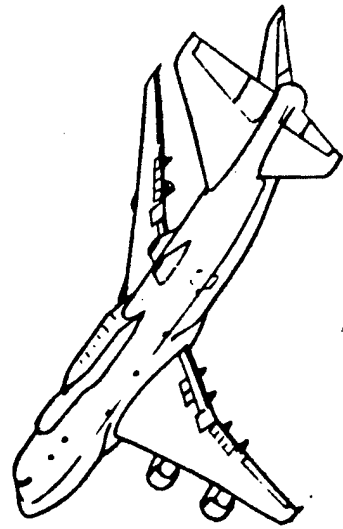
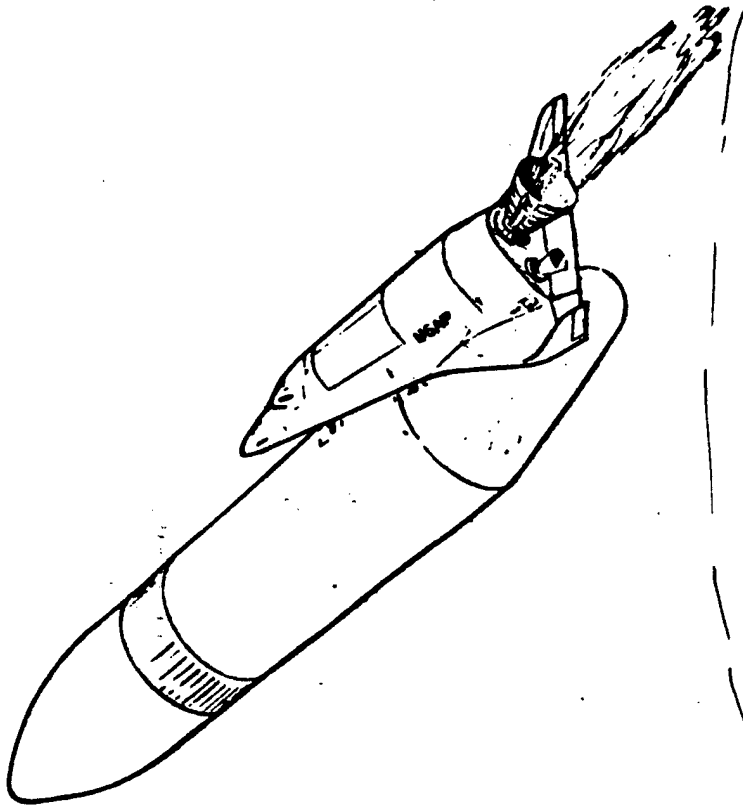

- SINGLE SSME + PAIR OF STANDARD RL10'S
- INCREASED T/W ELIMINATES NEED FOR ROCKET AUGMENTATION OF 747
- AIR LAUNCH GLOW INCREASED TO 425,000 LBS.
- 5,000 LBS PAYLOAD TO 500,000 FT POLAR ORBIT

## AIR LAUNCH SORTIE SYSTEM FEATURES

The figure on the facing page shows the key system features of the Air Launch Sortie system. The first three features point out the fact that the system is autonomous. The system can be launched from any 10 to 12,000-ft runway in the world, be dispersed when under alert and then recalled, and it can be launched on warning. The next three features show the flexibility of the system. The system has fast response and can fly over any spot on the earth within about 100 minutes. The vehicles have a wing loading such that it can land on any 10 to 12,000-ft field in the world, and, because it's airborne, it can arrange its flight path such that it can be launched with all azimuth.

BOEING PROPRIETARY

# Air Launch Sortie System Features

- ANY AIR FORCE BASE OR LARGE COMMERCIAL AIRPORT CAN BE "LAUNCH" BASE
- DISPERSIBLE, ALERT STATUS CAPABILITY (PROPELLANTS INSIDE LAUNCH PLATFORM)
- LAUNCH PLATFORM CAN TAKE OFF ON WARNING - MAY BE RECALLED
- FLY OVER ANY POINT ON EARTH WITHIN 100 MINUTES OF ALERT
- SORTIE VEHICLE CAN LAND AT ANY LARGE AIRPORT OR BASE IN THE WORLD
- POINT OF LAUNCH VARIABLE WITH ALL AZIMUTH CAPABILITY
- AUTONOMOUS OPERATIONS - DATA TO USER IN 150 MINUTES FROM ALERT
- SORTIE MISSION SIZED SYSTEM - LOW OPERATING COSTS, FAST TURNOVER
- NEAR TERM OPTION



BOEING PROPRIETARY

ALSV RAPID RESPONSE SCENARIO (ONCE-AROUND MISSION)

The scenario on the facing page shows a typical mission response. The fact that the vehicle would be on the ground with its fuel in its dewars enables it to remain in this ready condition as long as about thirty days. On receipt of a launch command it could be off the ground in five minutes, therefore meeting the SAC bomber alert. It takes thirty minutes to climb to its cruise altitude, at which time, if it's still under launch command, it would transfer propellant into the external tank and into the Sortie vehicle. While the tanks are being filled, instructions would be initiated translating the launch command into a set of steering commands for the vehicle itself. Some twenty minutes later the vehicle will have been topped off and is ready for launch. If final launch authority is received, then in five minutes it will launch. The mated vehicles perform a pull-up maneuver using the 747 engines and the outboard engines on Sortie vehicle. After about 1 minute the 747 goes through a pushover maneuver so it generates negative g's and the vehicles separate. After separation the Sortie vehicle would go up to full thrust. At about 20 to 21,000 ft/s and stage the external tank and the vehicle itself would continue on into orbit. The vehicle has enough on-orbit capability for several orbits to one or two days. At the appropriate time it would deorbit, glide down to earth, and land.

# ALSV Rapid Response Scenario (Once Around Mission)

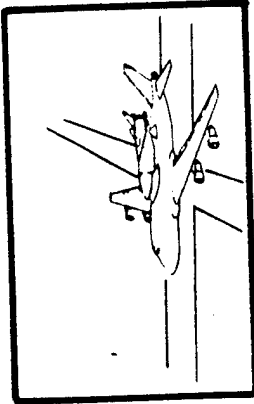

AIR LAUNCH SYSTEM ON STAND-BY. DROP TANK CHILLED BY BOILOFF VAPOR. t = 0 RECEIVES LAUNCH COMMAND

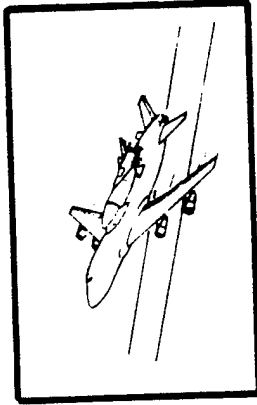

T+5 MIN, AIRCRAFT/ALSV LIFTOFF

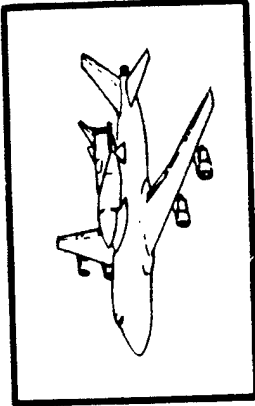

T+30 MIN, REACH CRUISE ALTITUDE (26,000 FT) AND START PROPELLANT TRANSFER. ON BOARD UPDATE OF GUIDANCE & NAV. UNDERWAY

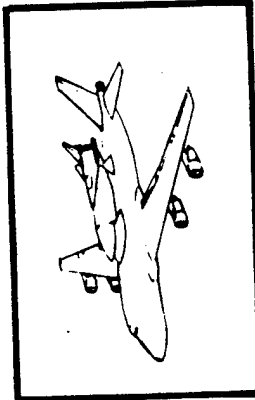

T+55 MIN, TANKS TOPPED-OFF SYSTEMS STATUS = STANDBY FOR LAUNCH. ENGINE CHILL-DOWN STARTS

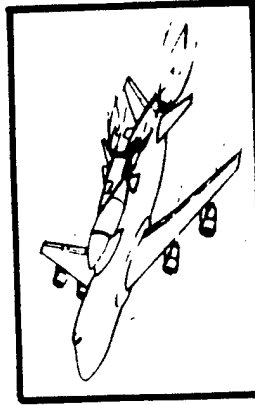

T+80 MIN, LAUNCH INITIATED. 747 THRUST AUGMENTATION & OUTBOARD ALSV ENGINES IGNITED DURING LAUNCH MANEUVER



T+185 MIN, ALSV RETURNS TO BASE

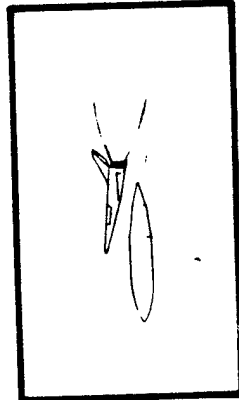

T+66.5 MIN, DROP TANK SEPARATION  
T+68 MIN, MECO



T+106 MIN, ALSV FLIES OVER FURTHEST SPOT ON EARTH

**BOEING PROPRIETARY****BASELINE CONCEPT B-2 ORBITER**

The facing figure shows the characteristics of the baseline orbiter vehicle. The structure is graphite epoxy or graphite polyimide composite. This is covered with an advanced ceramic thermal protection system. Key features of the thermal protection system are: carbon carbon at the nose, a high-density tile material on the leading edges, a lower density fibrous refractory material on the underside, and a flexible thermal protection system which covers the top. The vehicle is nominally shown with one crew member, although the cockpit has been sized to take two crew members; has a 7 x 15-ft payload bay; carries approximately 16,100 lb of internal L<sub>2</sub>/LH<sub>2</sub> propellant in a mixture ratio of 6:1. As shown, it has wing tip fin controllers, carbon carbon body flap, and is designed with a single standard SSME and two orbital maneuvering system engines which would be RL10A-3-3A's.

BOEING PROPRIETARY  
**Baseline Concept B-2 Orbiter**

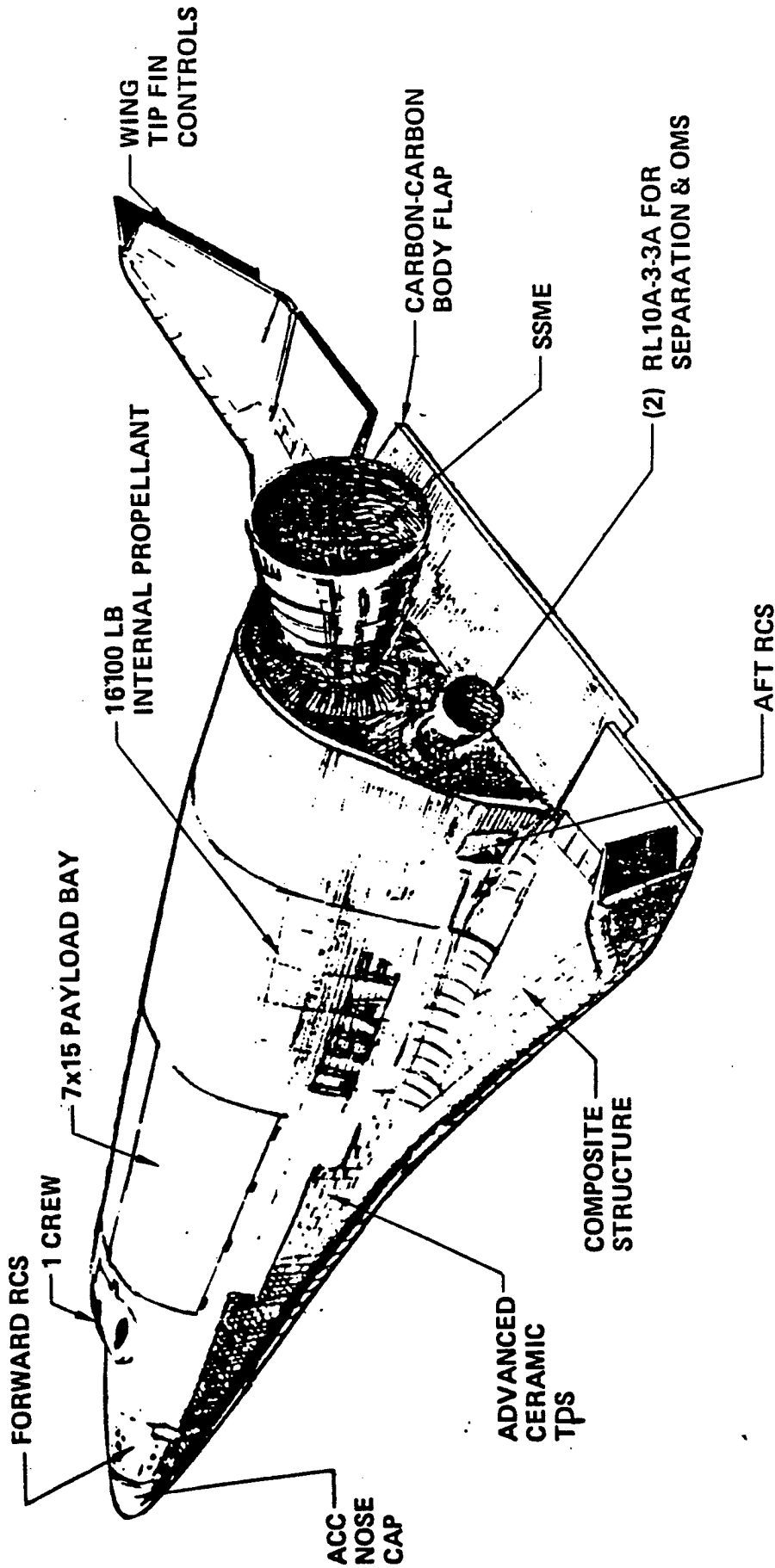

BASELINE B-2 CONCEPT USES  
EXISTING TECHNOLOGY THROUGHOUT

**BOEING PROPRIETARY**

**CONCEPT B-2 ORBITER CONFIGURATION**

The facing figure shows a three-view configuration drawing of the baseline concept. An important factor is that the entry wing loading raises the temperature to the point which precludes metal TPS and forces the use of a ceramic TPS. The landing wing loading is within the same range as the shuttle orbiter, so we would expect approximately the same characteristics. The system as shown is sized for a glow of 425,000 lb.

BOEING PROPRIETARY

# Concept B-2 Orbiter Configuration

CHARACTERISTICS
S <sub>W</sub> (TRAP) = 940 FT <sup>2</sup>
STF = 67 EACH
W/S ENTRY = 36.7
W/S LANDING = 43.7
GROSS WEIGHT = 59,350
W <sub>PROPELLANT</sub> = 16,100
SYSTEM GLOW = 425,000 LB

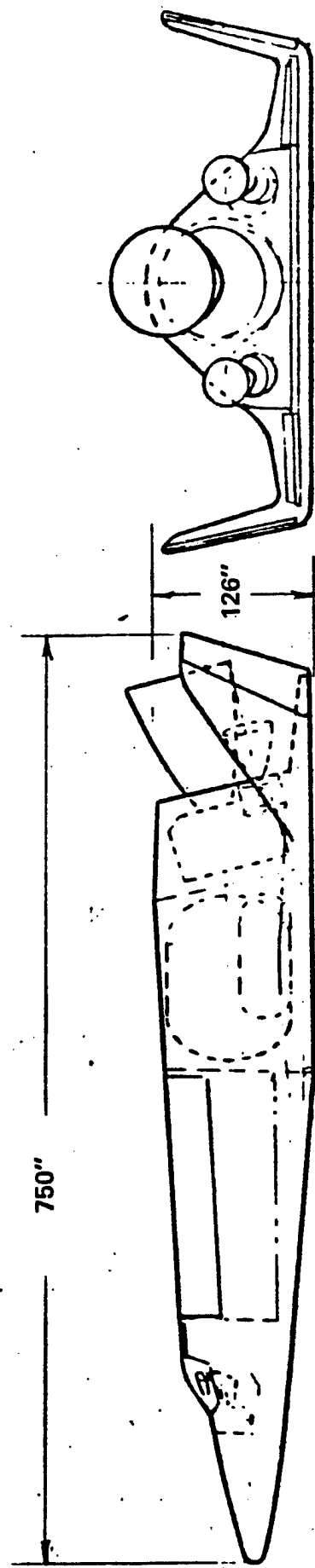
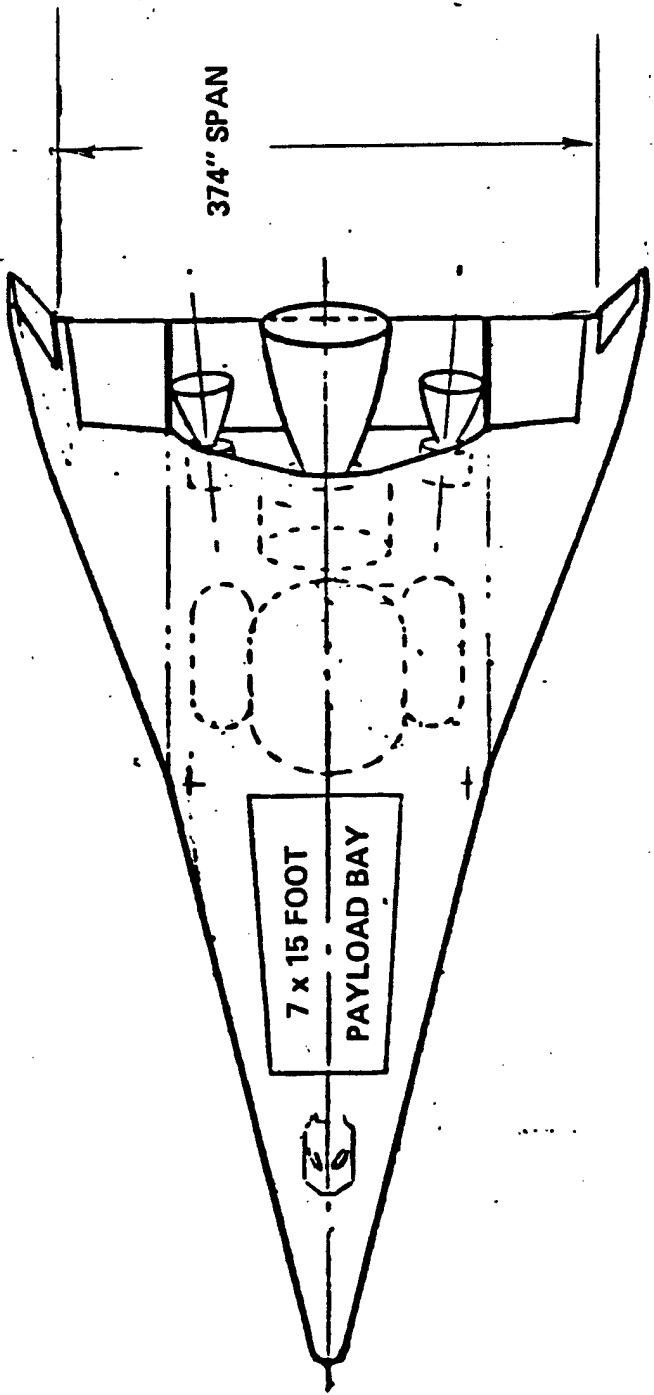

**BOEING PROPRIETARY**

**DROP TANK CONFIGURATION**

The drop tank configuration shown on the opposite page is an all-aluminum drop tank of skin and stringer construction designed to carry 344,450 lb of L<sub>02</sub>/LH<sub>2</sub> propellant at a 6:1 mixture ratio. Configuration of the drop tank is similar to that shown in the earlier air launch Sortie vehicle study and has just been sized up to meet the larger propellant requirements for this study.

BOEING PROPRIETARY

# Drop Tank Configuration

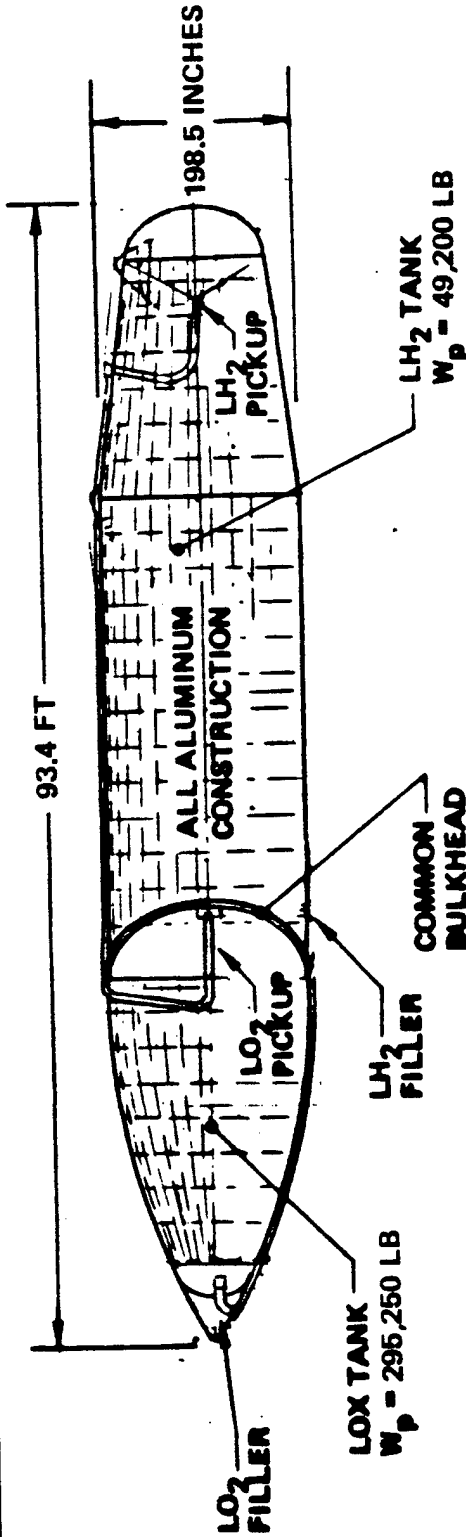

<b>STRUCTURES WEIGHT</b>	12,690 LB	<b>USABLE PROPELLANT</b>	= 344,450 LB
<b>TPS WEIGHT</b>	930	<b>GROSS WEIGHT</b>	= 365,650 LB
<b>PROPULSION/MECHANICAL</b>	2,680	<b>MASS FRACTION, λ'</b>	= 0.942
<b>ELECTRICAL/INSTRUMENTATION</b>	200		
<b>ATTACHMENT/SEPARATION</b>	600		
<b>RANGE SAFETY</b>	200		
<b>10% GROWTH</b>	1,730		
<b>(DRY WEIGHT)</b>	(19,030 LB)		
<b>RESIDUALS</b>	2,170		
<b>(INERT WEIGHT)</b>	(21,200 LB)		



**BOEING PROPRIETARY****747 GROWTH DERIVATIVE LAUNCH PLATFORM**

The airplane configuration shown is one of several possible growth derivatives of the existing 747-200 freighter airplane. The particular configuration shown is a 7,000-ft<sup>2</sup> aspect ratio 9 wing. This vehicle was originally sized as a possible commercial derivative. As such it had insufficient material in the wing root to withstand the larger bending stresses we will require. As a part of a study the additional material was added to that design which allows us to get up to a max zero fuel weight of 944,200 lb. This allows us to carry on the centerline almost 500,000 lb, 425,000 of which would be payload the other would be equipment in the form of dewars, launch personnel, equipment, etc. The configuration shown has a V tail, that's an option to the conventional tail. The idea for the V tail being this would allow us to use orbiter thrust to obtain a higher flight path angle and altitude before we separated.

BOEING PROPRIETARY

# 747 Growth Derivative Launch Platform

## AIRPLANE CHARACTERISTICS

WING AREA = 7000 FT<sup>2</sup>  
ASPECT RATIO = 9.06  
TAKEOFF GROSS WT = 1,144,200 LB  
MAX ZERO FUEL WT = 944,200 LB  
MAX LANDING WT = 1,004,200 LB  
OPERATING EMPTY WT = 506,620 LB  
MAX LAUNCH WT = 425,000 LB  
A/P MISSION FUEL = 200,000 LB

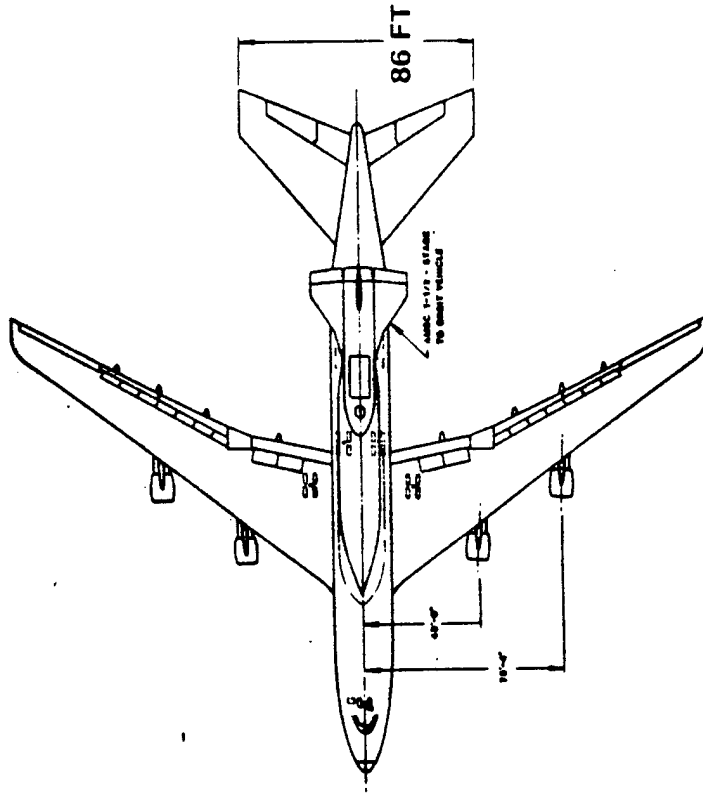

(2) LO<sub>2</sub> TANKS

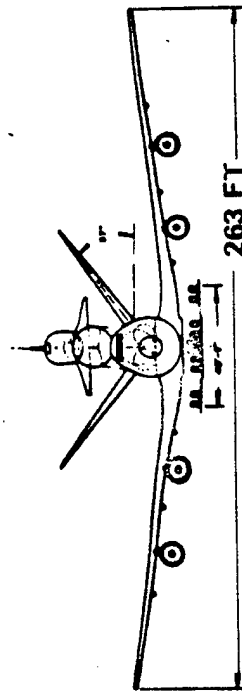
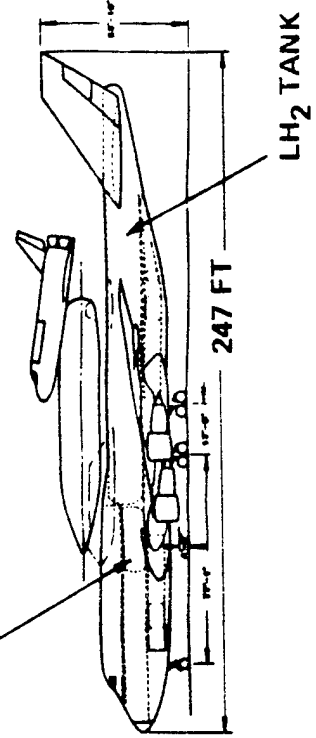

**BOEING PROPRIETARY****747 GROWTH DERIVATIVE PAYLOAD-RANGE CAPABILITY**

The payload range curve shown opposite is for the aspect ratio 9 7,000-ft<sup>2</sup> 747 derivative study airplane. This vehicle has a max payload of about 260,000 lb over a range of almost 6,000 mi. When takeoff gross weight limited to a million pounds, this vehicle can carry approximately 120,000 lb out to 9,000 mi where it becomes fuel capacity limited. This vehicle has interesting characteristics as a possible tanker or freighter for U.S. Air Force applications.

BOEING PROPRIETARY

# 747 Growth Derivative Payload-Range Capability

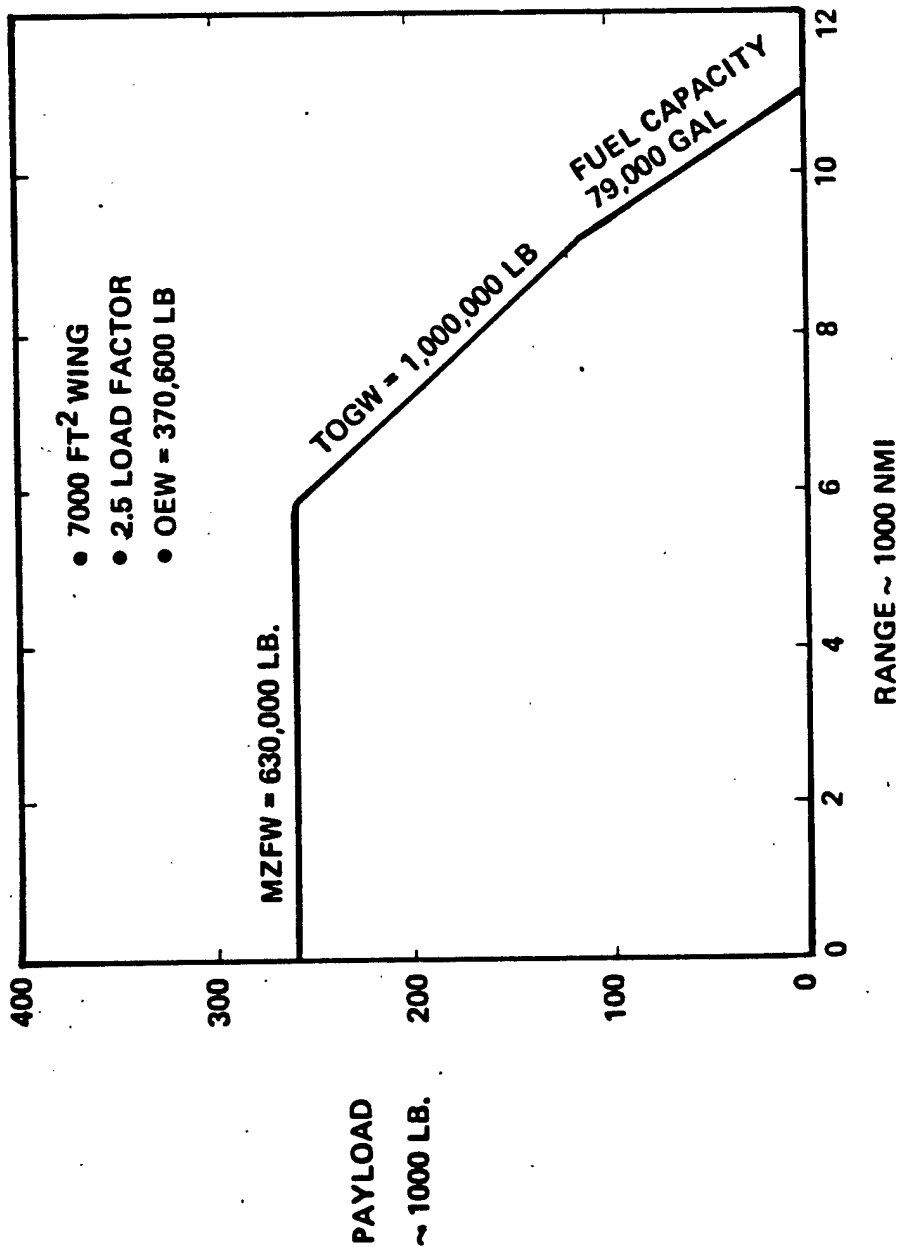

BOEING PROPRIETARY

CONCEPT COMPLIANCE WITH OPERATIONAL REQUIREMENTS AND DESIGN OBJECTIVES

The stage-and-a-half air-launch TAV with its autonomous capability, its flexibility of operation, and its potential low development cost should be able to meet or exceed the TAV operational requirements. The 747 derivative airplane is capable of operating out of more than 800 air fields worldwide, which means the vehicle is capable of operating out of anywhere in the world. The system has a capability of launching two missions per day using the single-carrier aircraft. It is more cost effective to buy additional orbiters and integrate the payload with the orbiter and with an external tank well in advance and then integrate that system into the orbiter as required on a quick-turnaround basis. This is based on the fact that studies looking at shuttle orbiter characteristics have shown that it is very time-consuming to integrate the payload into an orbiter unless the orbiter and the payload both are made with universal type fittings which tend to be very bulky and heavy. As noted, the system is not completely reusable as it drops tanks but, depending on the mission model and the number of flights flown, this system could easily have life cycle cost less than some of the reusable system candidates.

# Concept Compliance with Operational Requirements & Design Objectives

- THE STAGE AND A HALF AIR LAUNCHED TAV (CONCEPT B-2) CAN MEET OR EXCEED ALL THE BASELINE OPERATIONAL REQUIREMENTS. THE 747 DERIVATIVE CARRIER AIRCRAFT CAN OPERATE OUT OF MORE THAN 800 AIRFIELDS WORLDWIDE.

## DESIGN OBJECTIVES ACHIEVED

- 5 MINUTE LAUNCH PLUS POTENTIAL OF AIRBORNE ALERT.
- 2 MISSIONS/DAY TURNAROUND FOR THE CARRIER AIRCRAFT
  - MORE COST EFFECTIVE TO BUY ADDITIONAL ORBITERS (THEY'RE SMALL) AND INTEGRATE THE PAYLOADS AND DROP TANKS IN ADVANCE.
  - TURNING AN ORBITER AROUND IN LESS THAN 24 HOURS WILL REQUIRE MANY COMPROMISES TO THE STRUCTURE, SUBSYSTEMS AND PAYLOADS WHICH WILL TEND TO INCREASE INERT WEIGHT AND IMPACT MISSION CAPABILITY
- THIS SYSTEM IS NOT COMPLETELY REUSABLE BUT MAY HAVE LIFE CYCLE COSTS COMPETITIVE WITH REUSABLE CONCEPTS DEPENDING ON MISSION MODEL.

CONCEPT COMPLIANCE WITH OPERATIONAL REQUIREMENTS  
AND DESIGN OBJECTIVES (continued)

The concept has 5,000 lb capability to once-around polar orbit--that's with the standard engines in existing technology. If more advanced engines are added to replace the SSME and the RL10's, then the payload will increase by approximately 4,000 lb. If more advanced structure and TPS are incorporated, it would add another 1200 lb of capability. If the 747 is improved such as by hydrogen duct-burning engines, we would expect considerable payload capability growth. These enhancements indicate that there's considerable growth capability left in the basic system as presented. Because the internal tanks are covered with foam, with low-boiloff characteristics, the vehicle could spend appreciable time on orbit if either solar panels or fuel cells and a better life-support capability is added to the system.

## Concept Compliance with Operational Requirements & Design Objectives (Continued)

- THIS CONCEPT IS NOT A SINGLE STAGE SYSTEM
- SINGLE STAGE DESIRABLE FOR GROUND HANDLING
- SSTO'S ARE HIGHER DEVELOPMENT RISK
- BASELINE PAYLOAD—5000 POUNDS TO LOW POLAR ORBIT
- ADVANCED ENGINES ADDS 4000 LBS
- OTHER TECHNOLOGY ADVANCES (15 → 10% WEIGHT GROWTH) ADD 1200 LBS
- CONCEPT PAYLOAD LIMITED BY 747 CARRY CAPABILITY
- THIS CONCEPT CAN SPEND DAYS ON-ORBIT WITH ADDITIONAL OMS PLUS EPS AND LSS KITS
- INTERNAL PROPELLANT TANKS ARE DESIGNED FOR LOW ON-ORBIT BOILOFF
- BATTERIES REPLACED WITH FUEL CELLS
- ADDITIONAL O<sub>2</sub> AVAILABLE FROM FUEL CELL TANKS



**MISSION CAPABILITY**

The basic B-2 system concept has 5,000 lb once-around polar capability. When launched into 28.5 deg inclination, the system can deliver 8,000 lb into a 160 nmi orbit. The vehicle also has some capability to a 250-mi orbit being able to fly approximately 2,000 lb to a 250-mi circular orbit.

BOEING PROPRIETARY

# Mission Capability

## Concept B-2

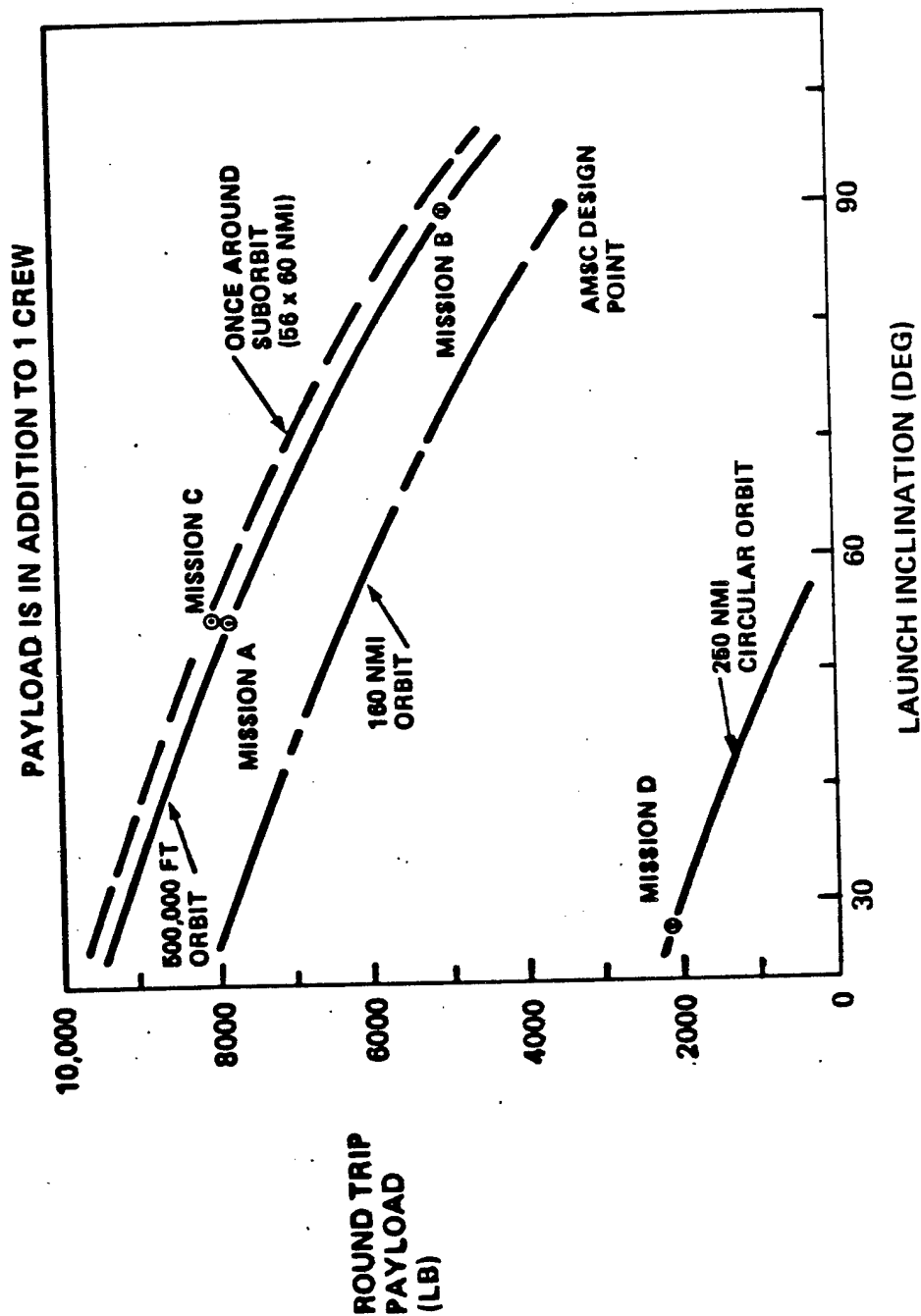

**BOEING PROPRIETARY****TAV CONCEPT B-2 PROGRAM SUMMARY**

The concept B-2 program is basically a low-risk, short-development-time effort (seven-and-one-half years from the very start of concept definition to the delivery of hardware). The estimated cost of \$4.2 billion is fairly low compared to the amount of capability it buys. The \$11.4 billion hardware/facilities investment is based on a baseline scenario utilizing a constant 1 to 5 booster TAV ratio. The \$14.1 million operational cost per flight is approximately 60% fixed, due to personnel manning requirements at the 10 bases. The cost per flight is very much a function of the number of flights per year. At 100 flights per year per base, one would expect to get the per-flight cost down to the order of \$6 to \$7 million.

# TAV Concept B-2 Program Summary

- o 1 YEAR CONCEPT DEFINITION PHASE
- o 6 ½ YEAR FULL SCALE DEVELOPMENT PHASE
  - o 4 YEARS FROM ATP TO 747 TEST AIRCRAFT DELIVERY
  - o 4 ½ YEARS FROM ATP TO TAV TEST VEHICLE DELIVERY
- o \$4.2 BILLION DEVELOPMENT COST
- o \$11.4 BILLION HARDWARE/FACILITY INVESTMENT COST
  - o 10 CARRIER AIRCRAFT
  - o 50 TAV
  - o 10 BASES
- o \$14.1 MILLION OPERATIONAL COST/FLIGHT (BASED ON 10 FLIGHTS/YEAR/BASE)

THIS PAGE INTENTIONALLY LEFT BLANK

## **2.3 Reusable Aerodynamic Space Vehicle (RASV), Concept B-3**

## ROCKET POWERED AIRCRAFT OPERATION

### Advanced Military Spaceflight

Military Space Operations continue to expand as technology provides both the United States and Foreign Powers capability to establish significant military balance of power through space operation and control.

Recognizing space as a potential major military operational arena, The Boeing Company has since 1972 been developing both systems and technology that meet Military operational needs and objectives. These developments have been directed toward fulfilling Military requirements that include:

1. "On Demand" Access to Space
2. ConUS to ConUS Flight
3. Low cost, fully reusable systems that provide access to all Earth orbital tracks.
4. Orbital payloads of sufficient size to accomplish "Orbit Change Missions" and/or terrestrial force deployment.

BOEING PROPRIETARY

# Reusable Aerodynamic Space Vehicle (RASV)

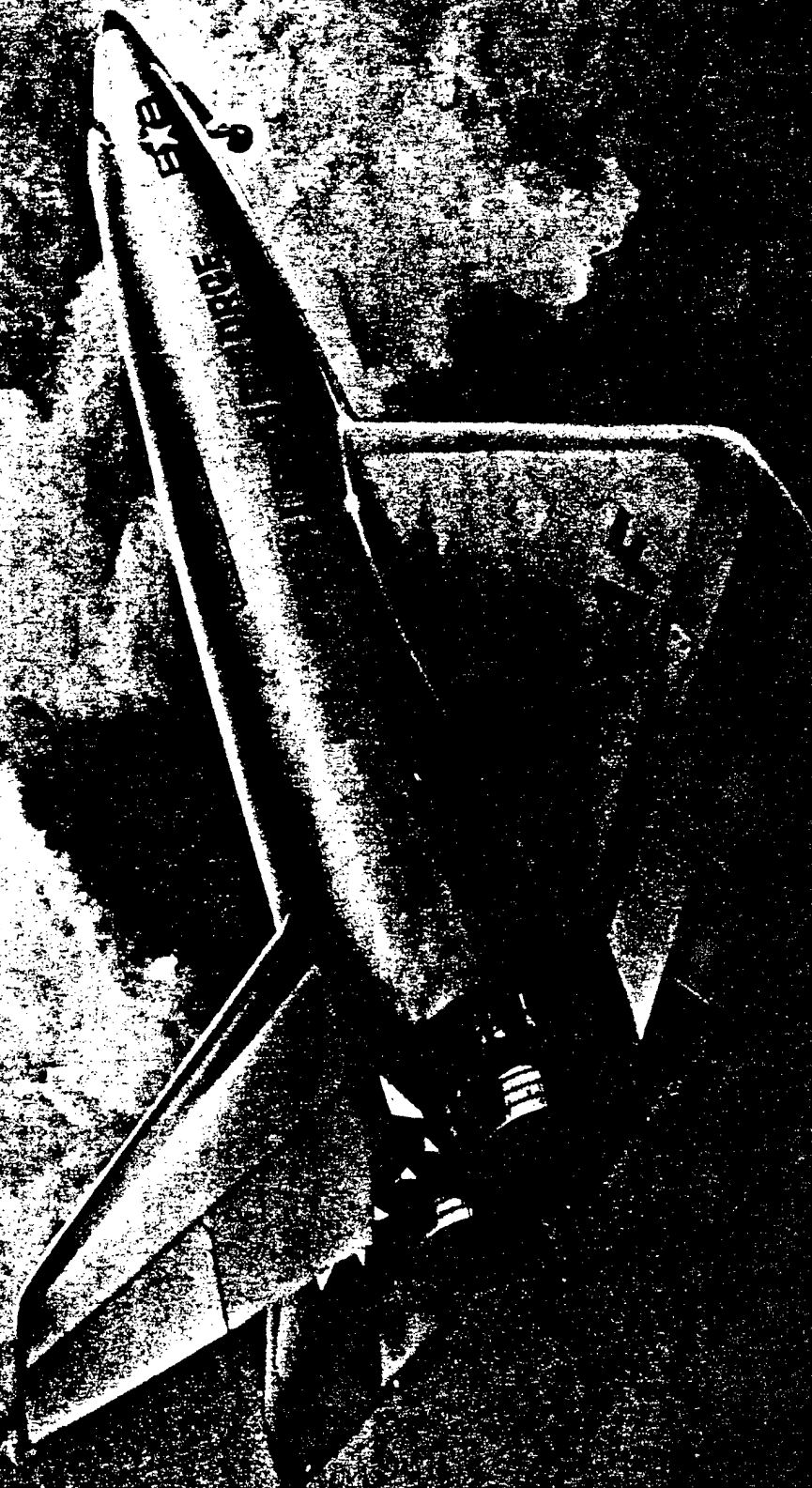



NEW TECHNOLOGY OPPORTUNITY  
HORIZONTAL TAKE OFF--ROCKET POWERED AIRCRAFT

Advanced Spaceflight/Transportation System Concept Studies were initiated in 1972 with the purpose of defining those technology developments required to provide low cost spaceflight transportation with operational flexibility and characteristics similar to airplanes.

Utilizing system and technology developments as demonstration of potential space transportation capabilities, SAC, ADCOM, Space Division and the Air Staff sequentially documented "Advanced Military Spaceflight, General Operating Requirements and Mission Element Needs."

Through a combination of Boeing Internal Research and NASA and Air Force sponsored System Studies and Technology Development Tasks, concept verification was demonstrated for fully reusable earth to spaceflight transportation systems.

# NEW TECHNOLOGY OPPORTUNITY HORIZONTAL TAKE-OFF - ROCKET POWERED AIRCRAFT

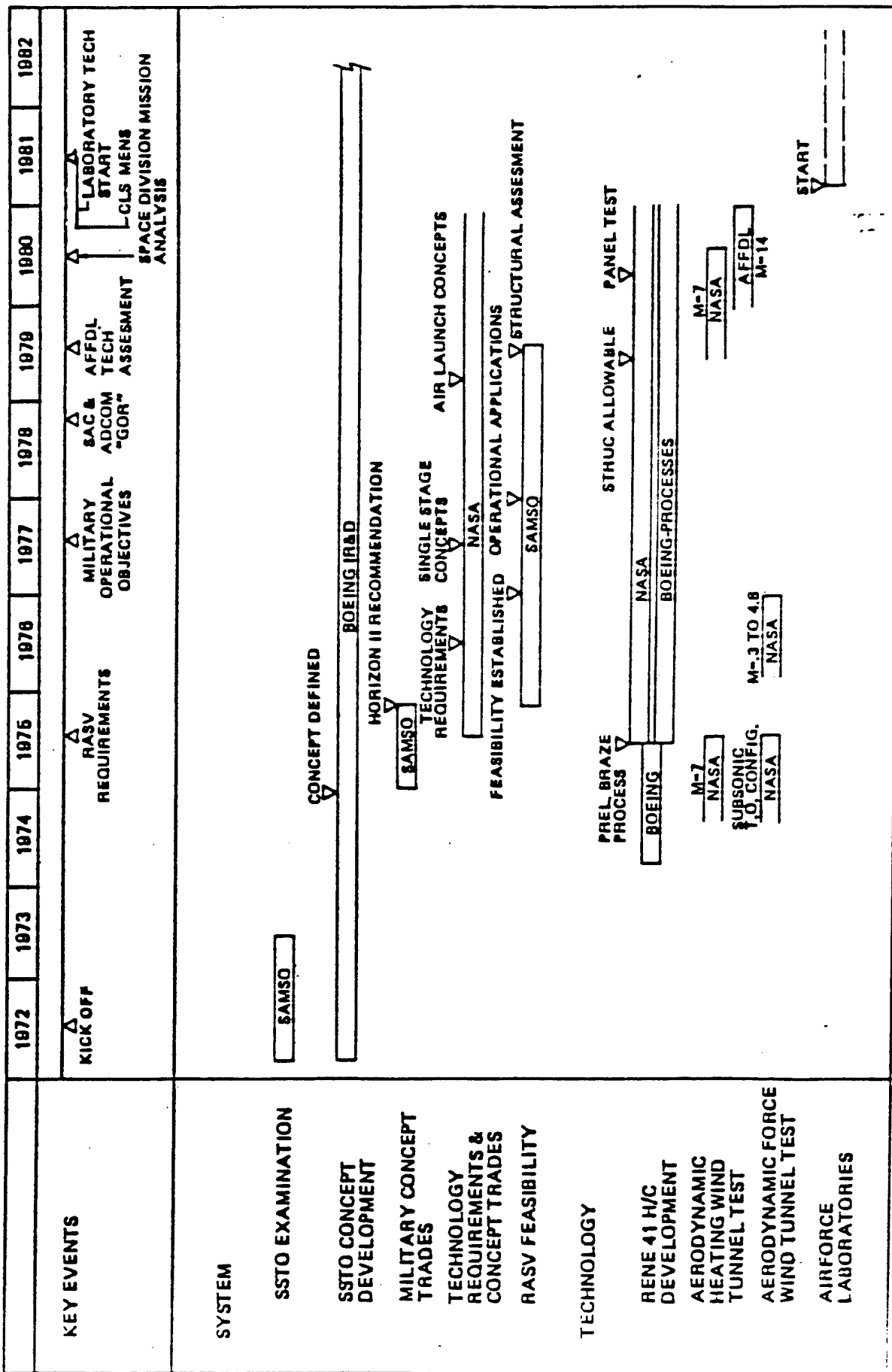

**BOEING PROPRIETARY****REUSABLE AERODYNAMIC SPACE VEHICLE (RASV)**

The Boeing Advanced Military Spaceflight studies have supported the evolution of the Rocket Powered Aircraft. The Reuseable Aerodynamic Space Vehicle (RASV) represents a two engine configuration of this class of vehicle.

The Rocket Powered Aircraft take off horizontally, perform an aerodynamic turn to the desired headings and then either fly ConUS to ConUS returning to preselected airports, one of which may be the take off site, or fly into a 100 nautical mile earth orbit. The terminal phase of flight is unpowered. A horizontal landing is performed. The aircraft is moved on its landing gear by tow truck during all ground operations. During the take off run, the aircraft is supported by a fully reuseable powered wheeled ground sled.

The RASV operation is as follows. The RASV is set on the take off support vehicle at an angle of attack of 8°. Lift-off occurs at 550 ft./sec. An aerodynamic lifting trajectory is flown through the sensible atmosphere. Either orbital or once-around flight is possible. Drying reentry, vehicle aerodynamic planform loading is held low (approximately 22 pounds/foot<sup>2</sup>), thus keeping temperatures to levels compatible with extensive use of the superalloys. The low wing loading provides for good cross range and relative low landing velocities and altitudes.

The ability for take off site escape is significant in that within 200 seconds after engine ignition, start of take off, the aircraft is 50 miles down range at an altitude of 120,000 feet. Further, during this flight phase, aerodynamic maneuvers may be performed to acquire any heading within plus or minus 95° of the take off direction.

The horizontal take off/horizontal landing fully reuseable spaceflight vehicles have characteristics that are consistent with the operating command operational requirements. Further, they provide configurations and weight distributions that result in aerodynamically stable systems.

The ability to fly like an airplane at thrust to weights as low as .3 results in good abort performance and acceptability for inland siting.

The significantly lower gross weight, fewer engines and simplified ground handling procedures result in major reductions to operating costs.

BOEING PROPRIETARY

# Reusable Aerodynamic Space Vehicle (RASV)

D180-27669-4

49

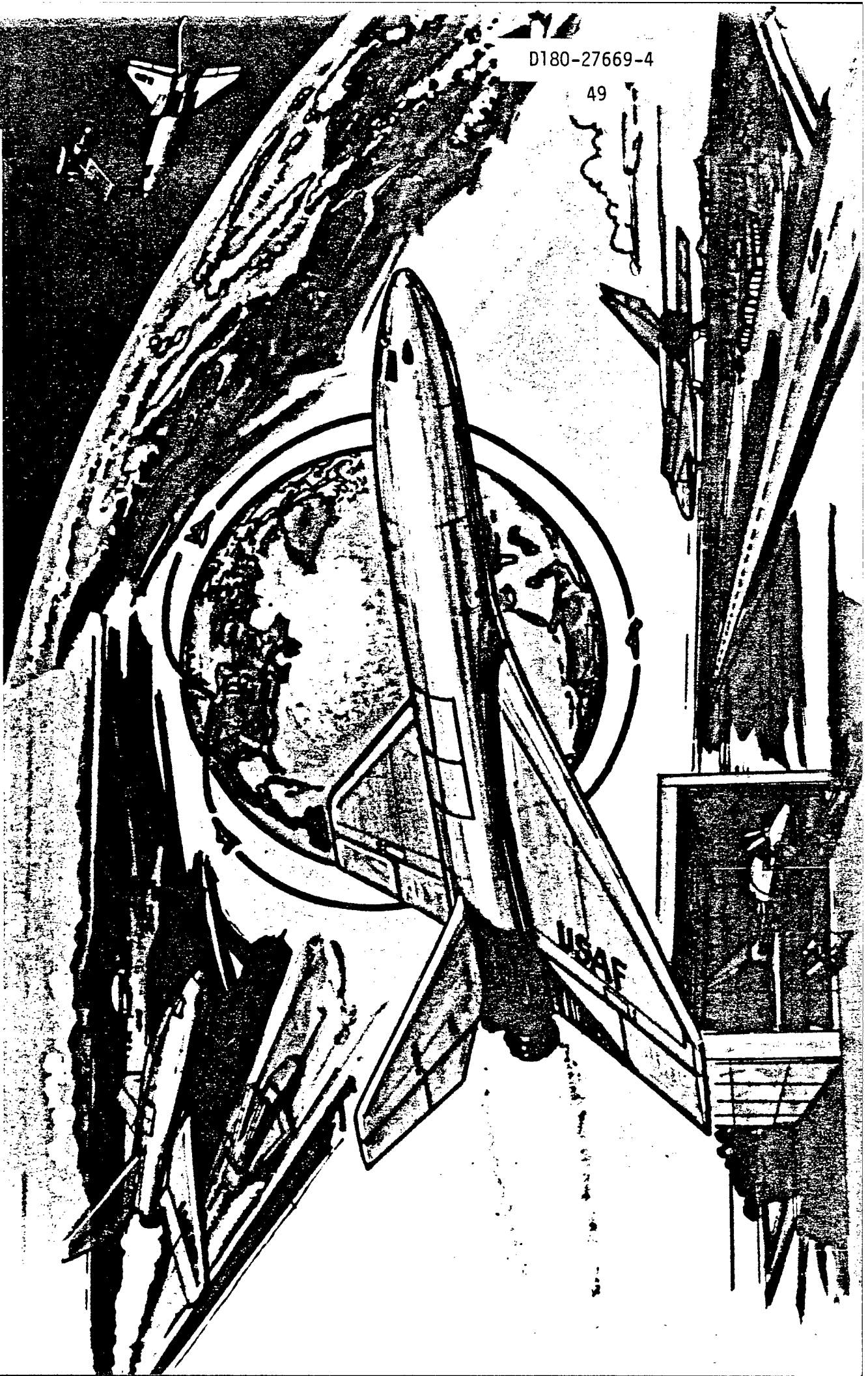

## RASV STRUCTURAL CONCEPT

The low planform reentry aerodynamic loading of the RASV ( $< 22$  pounds/foot<sup>2</sup>) results in operating temperatures that allow the use of titanium alloys on the upper surfaces and superalloys on the lower surface.

This results in the capability to use a structural concept consisting of aluminum brazed titanium honeycomb on the upper surfaces and brazed superalloy (Rene '41 and INCO 718) honeycomb on the lower surface of the liquid hydrogen (body) and liquid oxygen wing tanks. The honeycomb systems are brazed in a vacuum with sealed core. Their low conductivity at cryogenic temperatures is such that fuel boil-off rates are within acceptable levels for ground hold.

The use of these structural systems provides for a fully reuseable, durable, nondamage sensitive, all weather operation airframe.

BOEING PROPRIETARY

# RASV Structural Concept

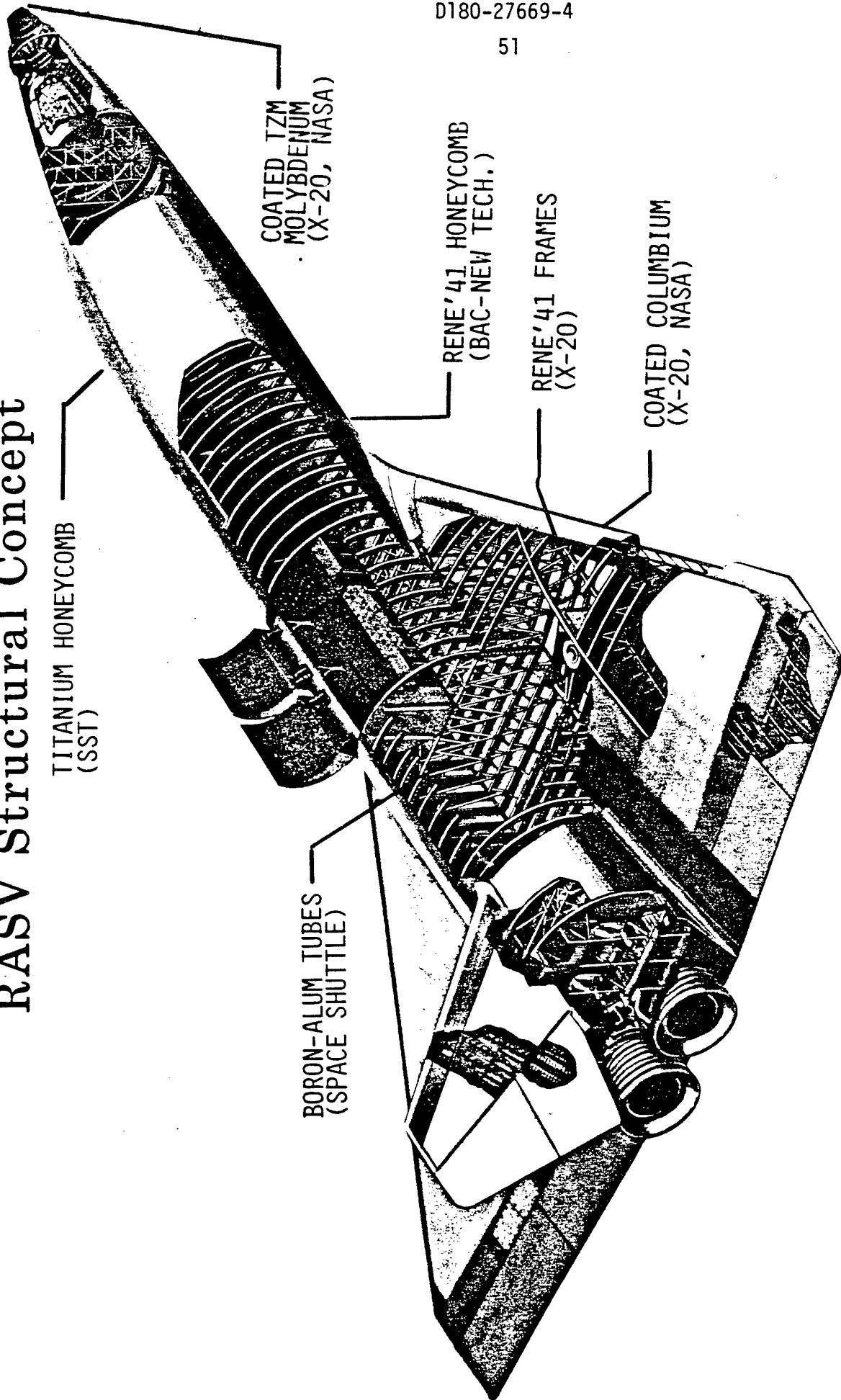

D180-27669-4

51

( ) TECHNOLOGY SOURCE

BOEING PROPRIETARY

### RASV PAYLOAD PERFORMANCE ANALYSIS

The payload performance of the two SSME rocket powered airplane configured for the Air Force is shown. The difference between the two lines is the weight of the Orbiting Maneuvering System Fuel that will provide a delta velocity of 250 feet per second. This performance is based on taking off east and then doing a subsonic turn into the desired orbit inclination. Taking off on an easterly runway and turning north reduced the payloads approximately 500 pounds but does facilitate southerly flight. The payload south is very close to the payload north.

# RASV Payload Performance Analysis

- LAUNCH SITE: GRAND FORKS, N.D.
- BURN OUT WEIGHT MINUS PAYLOAD = 134,340 LB
- SSME - 115% RATED POWER

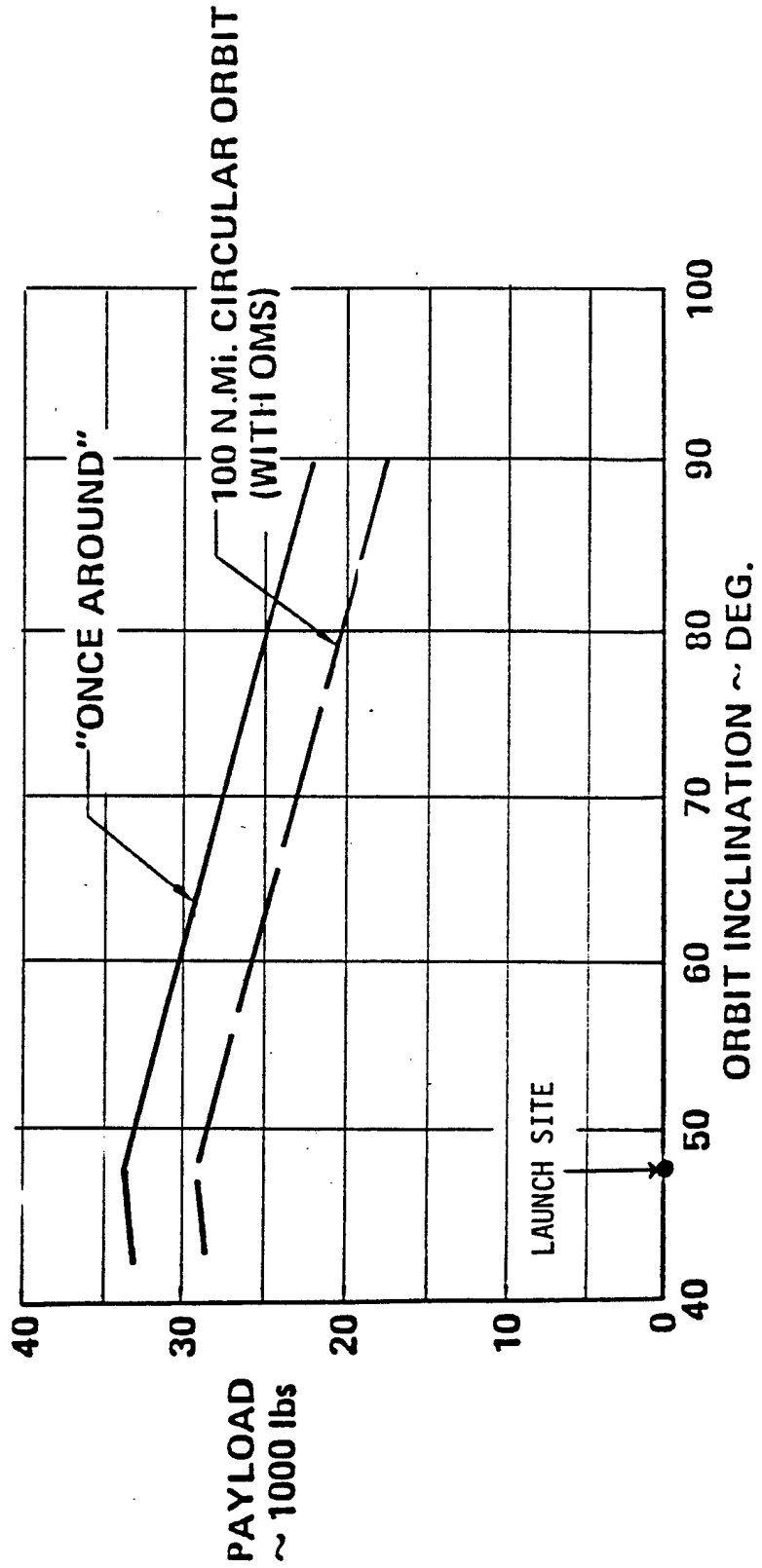



## DISPERSED BASING--RASV

Under current evaluation is the concept of replacing the rocket engines with jet engines in the take off support vehicle. With this configuration, the RASV can accomplish self dispersal flight to ranges of around seven hundred miles. With the RASV in the dispersal configuration (i.e., unfueled), take off and landing runway required lengths are less than 5,000 feet.

This self dispersal flight is feasible due to the low subsonic wing loading on the unfueled air vehicle (i.e., 26 pounds/foot<sup>2</sup>). Use of the jet engine pod will reduce spaceflight payload approximately 1400 pounds and increase the take off roll approximately 1500 feet. The payload reduction is due to the combination of needing more take off roll consumed propellants in the RASV, a more complex structural interface and additional control systems on the RASV.

Using the jet pod permits either predispersal or dispersal on demand to many airfields, lake beds, highways, etc. At these sites, the vehicle can be serviced by special over-the-highway equipment. The jet pod is to be configured such that it can be recovered/delivered by air carry.

BOEING PROPRIETARY

# Dispersed Basing Concept - RASV

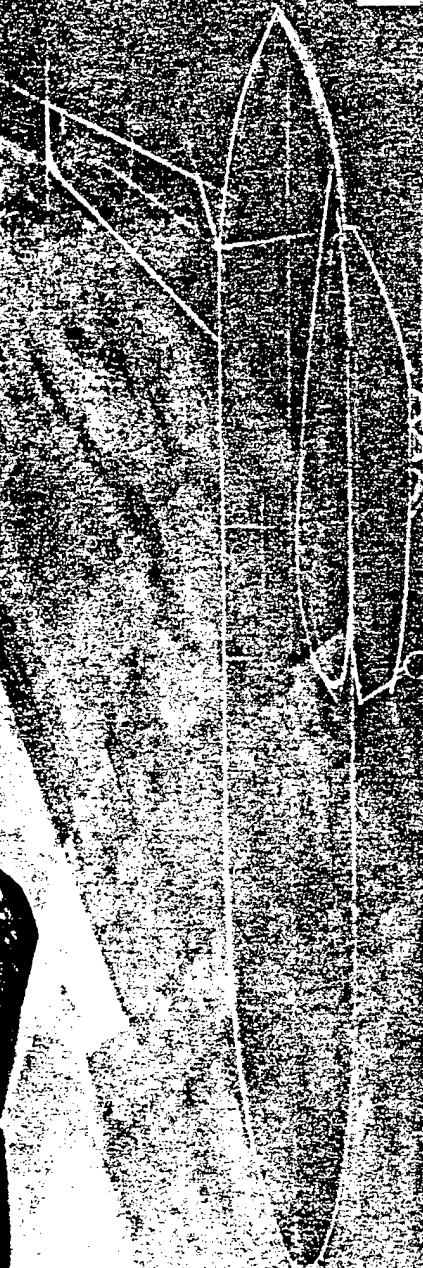
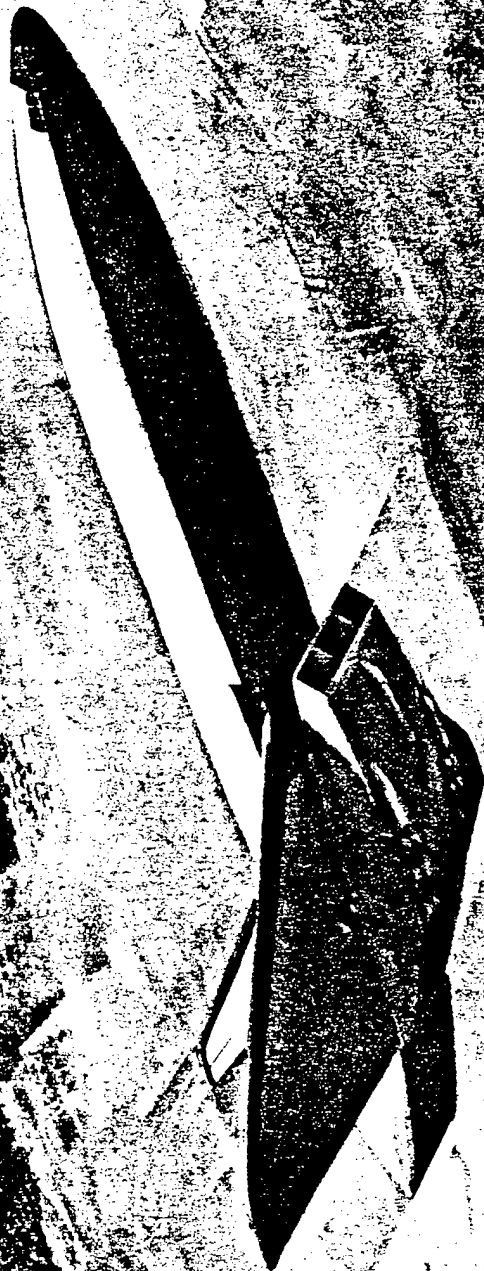

D180-27669-4

55

## RASV OPERATIONAL COST/FLIGHT

An Air Force sponsored study established and documented operational costs for the RASV. The engine costs were supplied by Rocketdyne and fully recognize refurbishment and replacement costs. Hydrogen costs are based on \$1.10 per pound. Costs were developed using functional timelines and historical data for rocket and aircraft systems.

The cost to service a fully fueled RASV during ground hold is shown. The \$1500/hour considers reliquification of the vented hydrogen gases. This cost was developed using the NASA sponsored study for use of liquid hydrogen as a fuel for the Boeing 747.

# RASV OPERATIONAL COST/FLIGHT DOLLARS IN THOUSANDS

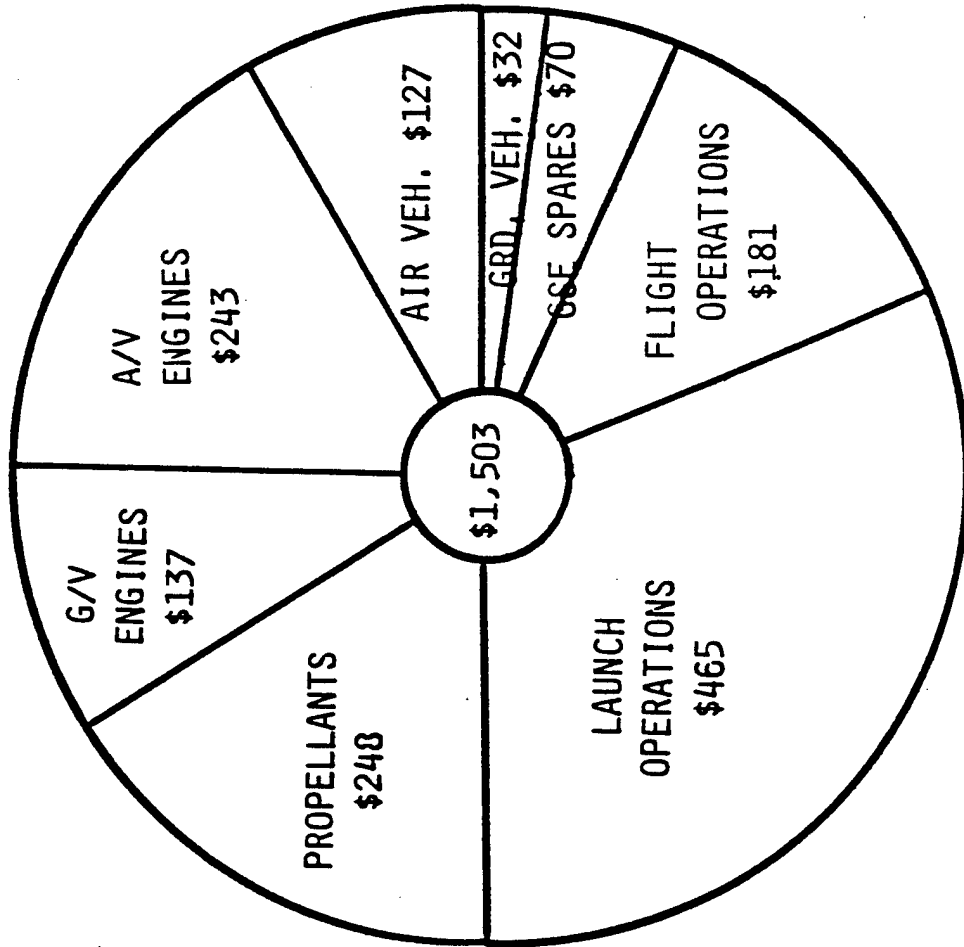

BASED ON 25 FLIGHTS/YEAR  
DOLLARS 1983. ▷

FUELED GROUND HOLD COST  
\$1500/HOUR

▷ SEE COST DATA SECTION 3.3.3

## DEVELOPMENT SCHEDULE

### REUSEABLE AERODYNAMIC SPACE VEHICLE

A detail schedule for the RASV concept definition, validation, development and flight test was developed in support of Air Force contracted studies. The scheduling was supported by personnel with experience on large Military Bombers, X-20 and the Supersonic Transport. Detail development and validation programs for each major subsystem were defined and scheduled.

The shown schedule is based on the position of having built development hardware prior to initiating design in the following phase.

Overlapping more of the full scale development phase with the validation phase could reduce the schedule to first flight by one to one and one half years. This approach still provides significant testing of validation hardware before initiation of major fabrication efforts on the flight test vehicle.

The use of an available existing engine, SSME, and existing available structural materials are essential to support this schedule.

# ROCKET POWERED AIRCRAFT DEVELOPMENT

## REUSEABLE AERODYNAMIC SPACE VEHICLE

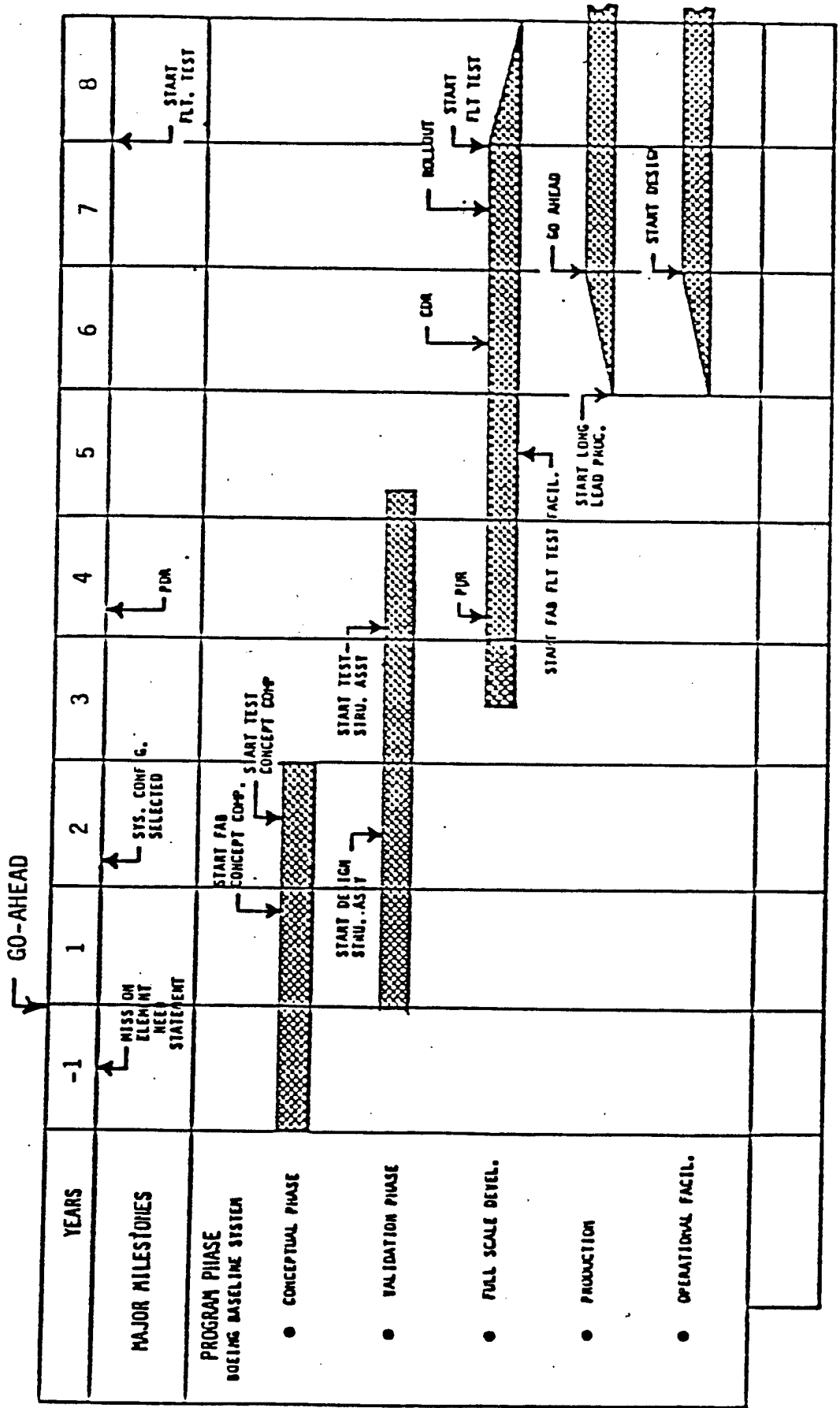

RASV COMPLIANCE  
TAV OPERATIONAL REQUIREMENTS

The RASV is fully compliant with the TAV operational requirements. The total design of the RASV system has been controlled to meet the requirements. Requirements identical to the TAV's were used in both early formulation and subsequent detail analysis of the RASV system. Compliance with these requirements is demonstrated in the reference documents attached to this report. The key RASV characteristics that show compliance are listed under each requirement.

# RASV Compliance TAV Operational Requirements

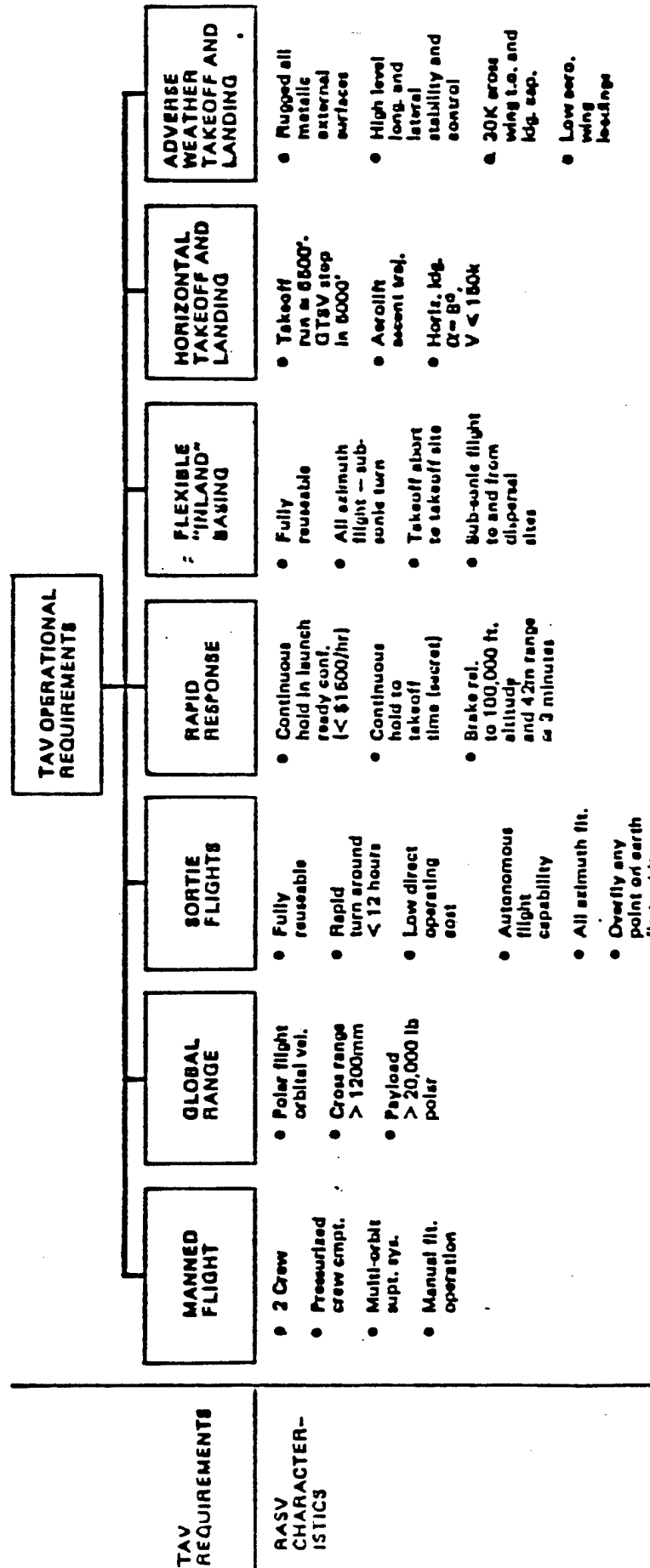



## RASV COMPLIANCE TAV DESIGN GOALS

The RASV is fully compliant with the TAV design goals. The RASV is a fully reusable, rugged, durable system that takes off horizontally with a single stage to accomplish both once around (ConUS to ConUS) and multiorbit flights. It can fly into any launch azimuth from a single easterly runway. The payload of 22,000 pounds polar once around exceeds the design goal. Under Air Force sponsorship, detail time lines and functions have been defined for both response time and turnaround times. These data are documented in classified reports.

Technical analysis demonstrating compliance with these TAV design goals is contained in a series of documents produced under Boeing IR&D and Air Force and NASA contracts.

# RASV Compliance with TAV Design Goals

TAV Design Goals	RASV Capabilities
(1) Response Time 5 Minutes Launch (From Alert Status)	SECRET--Ref. SAMSO TR-78-40, Vol. III
(2) Turnaround Time Two Missions/Day	SECRET--Ref. SAMSO TR-78-40, Vol. III
(3) Fully Reusable System	YES --Ref. SAMSO TR-76-223, Vol. II and III
(4) Single Stage Ground Launch	YES --Ref. SAMSO TR-76-223, Vol. II and III
(5) Baseline Payload (20,000# Polar Once Around)	YES --Polar Once Around Payload - 22,000# T.O. Site - Grand Forks, N.D.
(6) Maximum On-Orbit Stay-- Few (2 or 3) Orbits	YES --Requires $\Delta$ Wt. Increase of 2700 lbs. for Orbit and De-orbit Control $\Delta$ v 125 ft./sec.

### 3.0 Concept Development and Analysis





**3.1 Two Stage Fully Reusable  
Launch System Concept B-1  
Model (896-111)**

**3.1.1 Detailed Concept Definition**

## TAV GOALS

The goals shown were derived not only from the Battelle suggested goals, but from a need to establish additional guidelines for the designers and analysts doing the detail studies. It is possible to change the performance and cost of Concept B-1 by varying these assumptions. However, these goals were selected as typical for a military operational system. In some cases, revising the values will be prudent depending on the mission and/or operational mode selected.

# TAV Goals

●	MISSION - VEHICLE BASELINE DESIGN - ALL AZIMUTH LAUNCH				
○	MISSION	A* 	B* 	C* 	D 
○	LAUNCH LATITUDE, DEG	32	32	32	28.5
○	INCLINATION, DEG	55	90	55	28.5
○	ORBITAL ALTITUDE	500K FT	500 K FT	SUBORBITAL**	250 NM
○	PAYLOAD TO ORBIT, LB	25600	18300	27800	10000
○	PAYLOAD RETURN, LB	12800	9200	13900	5000
○	MISSION DURATION (ORBITS)	ONE	ONE	ONE	MULTIPLE
○	ORBIT TYPE-	CIRCULAR	CIRCULAR	SUBORBITAL**	CIRCULAR
○	OMS - FT/SEC	350	350	0	1000+
○	RCS - FT/SEC	100	100	100	100
○	LANDING CROSSRANGE - NM	1100	1100	1100	1100
●	ENVIRONMENT				
○	ARDC 1962 MODEL ATMOSPHERE				
○	PAYLOAD BAY VOLUME - 2000 FT <sup>3</sup> (DIMENSION USING 10 LBS/FT <sup>3</sup>  PAYLOAD DENSITY)				
○	PAYLOAD BAY ○ WALL TEMP. LIMITS + 150°F <sup>MAX</sup> TO -100°F MIN				
○	○ PRESSURE LIMITS S.L. TO VACUUM				
○	LOAD FACTORS - AXIAL +3g NOMINAL				
	YAW	+1g NOMINAL			
	PITCH	+2g, -1g NOMINAL			
	ULF	3.0			

\*USE FOR PERFORMANCE CALCULATIONS  BATTELLE REFERENCE MISSIONS  
 \*\*ONCE AROUND ORBIT

TAV GOALS

The basing goals shown are identified to clarify the values used for system design. Specifying SAC base use and SAC general runway sizes was a given requirement. The launch rate was selected to provide adequate launch pro-pellant margin for any mission surge condition. (At 100 flights/year from 10 SAC bases a capacity of one mission plus boil-off would be adequate.) The remaining goals were either specified directly or inferred by the general goal to develop a "Military Operational System."

# TAV Goals

BASING

- o SAC BASES, i.e., - 12,000 FT WITH 1000 FT OVERRUN  
- 300 FT WIDE
- 75 FT TAXIWAY WITH 50 FT SHOULDERS
- o LAUNCH RATE - 4 MISSIONS/WEEK/BASE
- o PROPELLANT STORAGE (FOUR MISSIONS/WEEK NOMINAL - FIVE MISSION CAPACITY)
  - o 550 K LBS LIQUID H<sub>2</sub>
  - o 3300 K LBS LIQUID O<sub>2</sub>
- o ALL WEATHER T/O AND LANDING \*
- o TOW TRUCK AIRPLANE MOVEMENT
- o STANDARD MILITARY MANNING
- o MINIMIZED SPECIAL EQUIPMENT AND TRAINING
- o TURNAROUND TIME - 12 HRS TOUCHDOWN TO L/O \*\*
- o RAPID RESPONSE - 5 MIN. L/O (AFTER ALERT) \*\*

\* BATTELLE REQUIREMENTS

\*\* BATTELLE GOAL



### TAV GOALS

The values listed were selected as first cut numbers to assist in specifying the system weight and ultimately the system performance (e.g., the life value of 500 uses and the gust speed relate to specify a load criteria for wing design and the takeoff distance defines sea-level thrust goal). Similarly, each of the goals given drive the air vehicle design. All are subject to review as the mission and/or operational scenario evolve further.

Two goals that are important considerations are the crew size and EMP hardness. The two-man crew will undoubtedly be necessary for the booster due to workload associated with large multiengine aircraft. However, a single pilot orbiter should be evaluated during the next phase. EMP hardness appears to be mandatory; however, overpressure and/or high gusts could cause structural weight penalty that would make a reasonable size TAV impossible due to the impact on structural efficiency factor.

# TAV Goals

- BOOSTER AND ORBITER
  - LIFE - 500 REUSES (6000 HRS) - 200 POLAR & 300 EAST LAUNCHES
  - T/O DISTANCE - 10,000 FT
  - LANDING DISTANCE - 5000 FT (ANTI-SKID SYSTEM)
  - TREAD WIDTH - 75 FT OR LESS (TAXIWAY CONSTRAINT)
  - SINK SPEED - 10 FT/SEC SYMMETRIC, 7 FT/SEC ROLLED
  - CROSSWIND - 40 FT/SEC
  - GUST SPEED - 50 FT/SEC
  - ENGINES BOOSTER -- SSME WITH 150 EXPANSION RATIO, TURBOFANS (UPRATED F-101)  
ORBITER - SSME WITH 150 EXPANSION RATIO, RL-10 (UPRATED 200 PERCENT)
  - PROPELLANT BOOSTER - LIQUID H<sub>2</sub>, LIQUID O<sub>2</sub> AND JP-4  
ORBITER - LIQUID H<sub>2</sub> AND LIQUID O<sub>2</sub>
  - STABILITY & CONTROL - MAINTAIN POSITIVE STABILITY MARGIN
    - SAFE ABORT WITH SINGLE ENGINE OUT
    - RETURN AND LAND AT TAKEOFF BASE
  - AVIONICS - AUTO TAKEOFF AND LAND
    - AUTONOMOUS ONBOARD OPERATION WITH ONBOARD TEST AND CHECKOUT
    - REDUNDANCY WITH GRACEFUL DEGRADATION AND FAULT TOLERANT ARCHITECTURE
    - EXISTING SOFTWARE (e.g., J-73 & COMPATIBLE SUPPORT SOFTWARE)
    - OPERATIONAL MEMORY + 100% FOR GROWTH
    - OPERATIONAL THROUGHOUT + 50% FOR GROWTH
  - CREW SIZE BOOSTER - 2 MAN  
ORBITER - 2 MAN (ACCOMMODATIONS FOR P/L ACCESS)
  - CREW COMPARTMENT - SHIRTSLEEVE ENVIRONMENT WITH SUBSONIC ESCAPE PROVISIONS
  - ALL SUBSYSTEMS WILL MAXIMIZE USE OF COMMON HARDWARE
  - HARDNESS - EMP DESIGN
    - B-52 OVERPRESSURE

## BOEING PROPRIETARY

## TWO-STAGE HTO LAUNCH SYSTEM CONCEPT B-1

Past studies conducted at Boeing pertaining to fully and partially recoverable Transatmospheric Vehicles have included comparisons of two- and three-stage vehicle systems utilizing either airbreathing or rocket propulsion or a combination of both in the first stage. The purpose of these studies was to design several launch systems varying the number of stages, type of boost fuel, staging velocity, and then compare the performance and cost data against one another.

The transatmospheric launch vehicle concept shown on the facing page is representative of a two-stage HTOHL (horizontal takeoff and horizontal landing) launch system having an airbreathing/rocket-powered reusable first stage, and a rocket-powered reusable upper stage. The first stage is designed to carry the upper stage in an underslung manner to facilitate stage separation and to eliminate some ground support mating equipment. The gross vehicle takeoff weight is 1,300,000 lb with the booster weighing 722,500 lb, the orbiter weighing 557,500 lb, and the payload weight 20,000 lb.

The overall booster/orbiter configuration is 230 ft long, has a wing span of 160 ft, and a 54-ft maximum vertical tail-to-ground dimension. The first-stage wings are mounted high on the forward fuselage with an incidence angle of 20°. A wing area of 9000 ft<sup>2</sup> provides a wing loading of 144 lb/ft<sup>2</sup> on takeoff. A wing leading edge angle of 55°, a taper ratio of .22, an aspect ratio of 2.84, and approximately 25 percent chord trailing edge devices and 10 percent chord leading edge devices result in a takeoff velocity of about 210 knots.

The booster forward body contains L02/LH<sub>2</sub> rocket propellants and a propellant crossfeed system to the orbiter to ensure that the orbiter vehicle propellant tanks are completely filled at stage separation. The JP-4 airbreathing fuel contained in the outboard wings to reduce the total wing bending moments at the side of body. The booster is designed for a two-man crew. Located forward, aft, and below the crew compartment are the avionics/electronics equipment compartments. ECS equipment, oxygen, and electrical/hydraulic subsystem equipment are located in the fuselage aft of the pilot.

The main gear consists of sixteen type VII 56 x 16 tires, loaded to approximately 75,000 pounds/wheel. Vertical loads go through the flow straightening grid structures in the inlet diffusers and then into the 50 percent wing chord spars. The gear retracts forward and partially into the inlet nacelle bottoms. The lower half of the wheel clusters are faired into the nacelles. The nose gear consists of two type VII 44 x 16 tires, loaded to approximately 48,000 pounds/wheel. The gear retracts rearward into a bay below and aft of the crew compartment.

The vertical tails are located on the wing tips to reduce the overall size required for directional and control requirements. The vertical tails have a leading edge sweep of 45°, an area of 720 ft<sup>2</sup> each, an aspect ratio of 1.77 and a tail volume coefficient of 0.064.

The first-stage booster is powered by eight advanced augmented airbreathing engines (F-101 uprated) each producing 35,000 lb static sea level thrust and one SSME rocket engine ( $\epsilon = 150$ ) having a vacuum thrust rating of 530,200 lb and an  $ISP_{VAC} = 463.5$  sec using L02/LH<sub>2</sub> propellants. The booster launch system utilizes airbreathing propulsion during the takeoff and climb to 30,000 ft and  $M = 0.86$ . At this time, the rocket engines on both stages ignite and operate until reaching 117,500 ft altitude and 3000 ft/s velocity where stage separation occurs.

# Two Stage HTO Launch System Concept B-1

(MODEL 896-111)

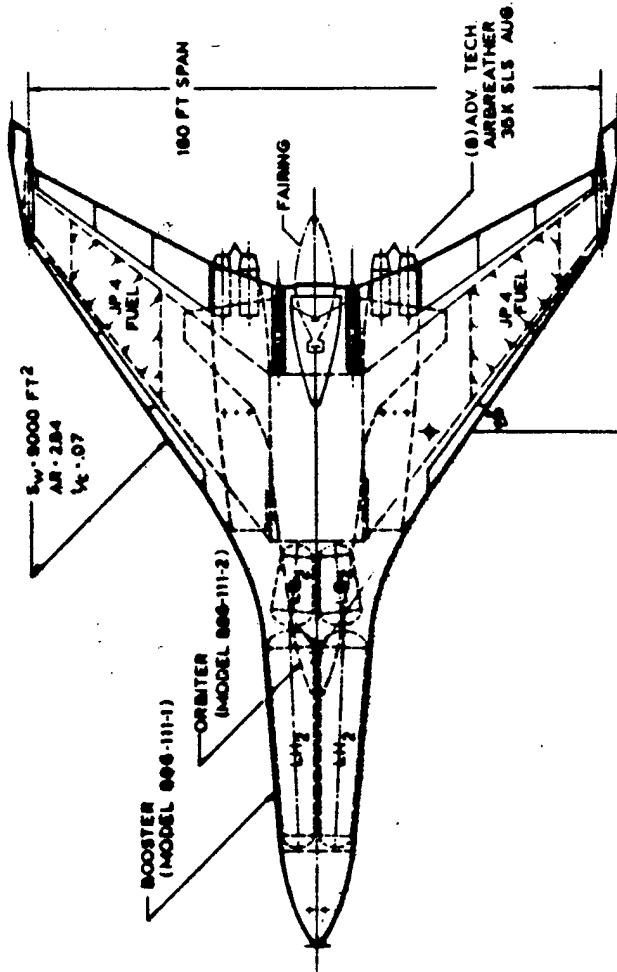

- LAUNCH WEIGHT = 1,300,000 LB
- BOOSTER WT = 722,500
- OWE = 295,000
- LO2/LH2 = 299,300
- JP-4 FUEL = 128,200
- ORBITER WT = 557,500
- INERT WT = 86,300
- LO2/LH2 = 471,200
- PAYLOAD WT = 20,000 (POLAR LAUNCH ONCE-AROUND)
- STAGING VELOCITY = 3000 FT/SEC

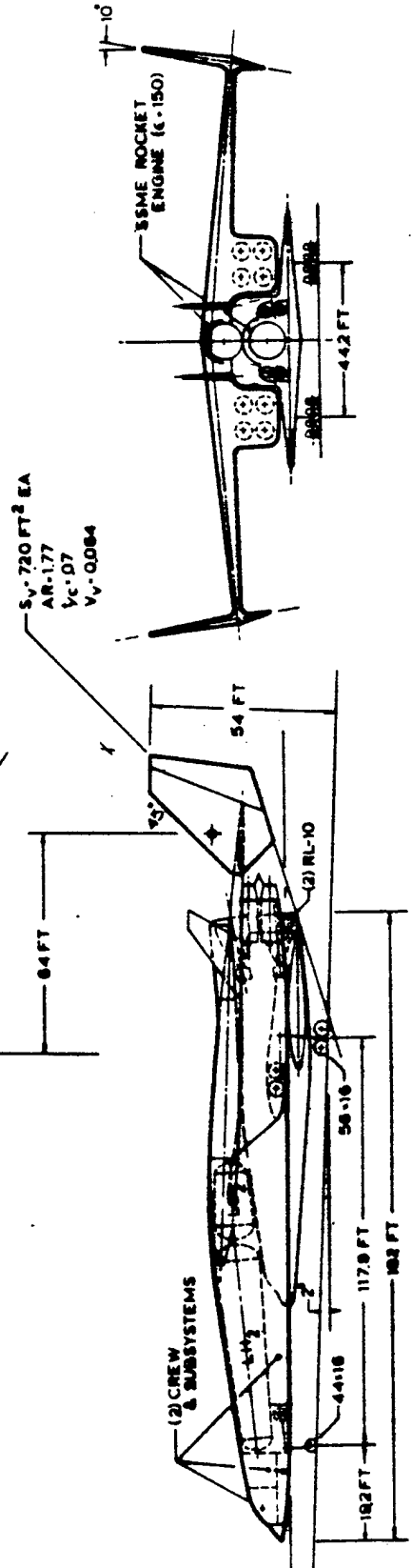

## BOEING PROPRIETARY

## ORBITER CONCEPT B-1 HOT STRUCTURE

The manned (2 crew) reusable orbiter concept is shown on the facing page. The overall start burn weight is 577,500 lb, the stage weight is 557,500 lb and the payload weight is 20,000 lb. This orbiter is powered by one 112 percent SSME rocket engine plus (4) advanced RL-10 rocket engines. The SSME produces 530,200 lbs of vacuum thrust at an  $ISP_{VAC} = 463.5$  seconds. The advanced RL-10s are capable of delivering 34,500 lbs of vacuum thrust each at an  $ISP_{VAC} = 430.9$  seconds. The total propulsion system uses 471,200 lb of  $LO_2/LH_2$  propellants from the initial staging velocity of 3000 ft/s (30,000 ft altitude) to a final orbital velocity of 25,800 ft/s and 303,820 ft altitude. The overall length of the orbiter is 113 ft, has a wing span of 71 ft, and a 40.5 ft vertical tail to ground dimension. The orbiter has an inert weight of 86,300 lb resulting in a  $\lambda = 0.845$  (structural efficiency parameter).

The orbiter wing is mounted low on the body to facilitate mating with the booster. The wing has a double break in the leading edge to provide clearance with the booster main landing gear struts when mated. The wing reference area is 2510 ft<sup>2</sup> resulting in a landing wing loading of approximately 35 lb/ft<sup>2</sup>. The  $LO_2$  propellant is contained in the wings between the front and rear spars and extends from buttock line zero to 0.75 semispan. The main landing gear is sized for landing weights only and are located in the wing structural box area. The nose gear is located below the crew compartment and consists of dual tires (22 x 6) and retract forward to stow. The forward body contains a two-man crew and the majority of the orbiter subsystems. The  $LH_2$  propellant is contained in the forward body and also in two cylindrical tanks on either side of the payload bay.

Twin vertical tails each having 152 ft<sup>2</sup> area are required for directional stability. These fins are mounted on the aft body, however, future orbiter configurations will investigate mounting fin on the wing tips.

BOEING PROPRIETARY

# Orbiter Concept B-1 - Hot Structure

(MODEL 896-111)

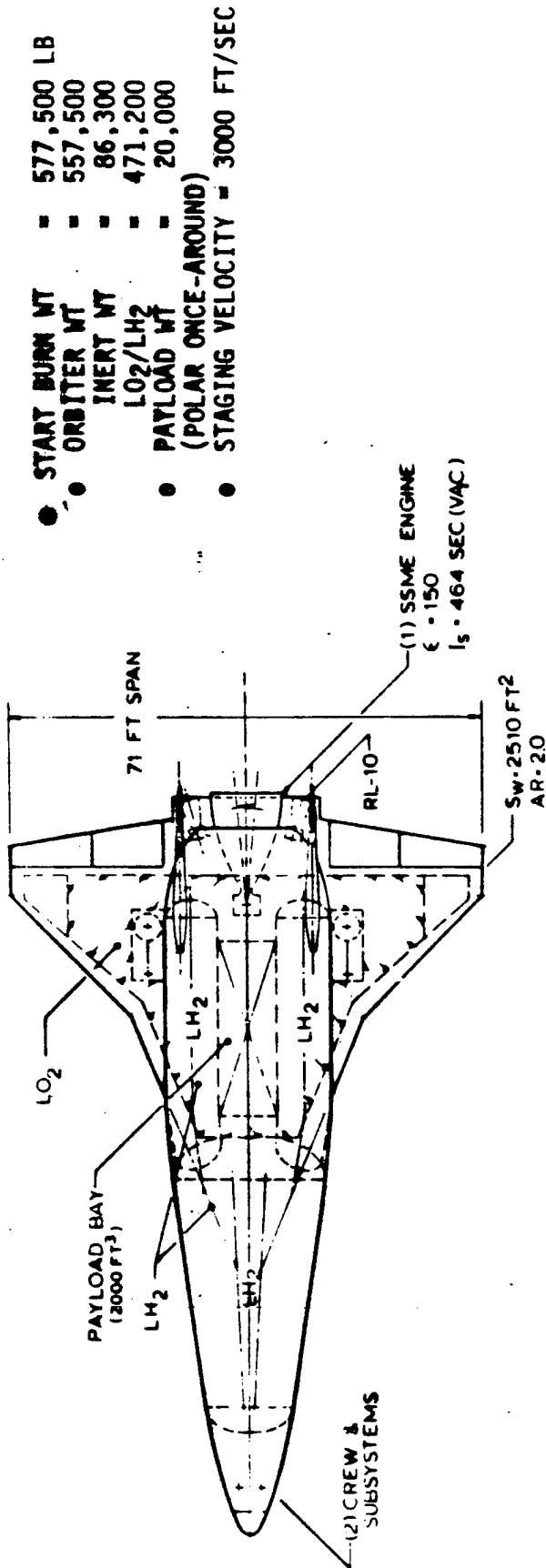

- START BURN WT = 577,500 LB
- ORBITER WT = 557,500
- INERT WT = 86,300
- LO<sub>2</sub>/LH<sub>2</sub> = 471,200
- PAYLOAD WT = 20,000
- (POLAR ONCE-AROUND)
- STAGING VELOCITY = 3000 FT/SEC

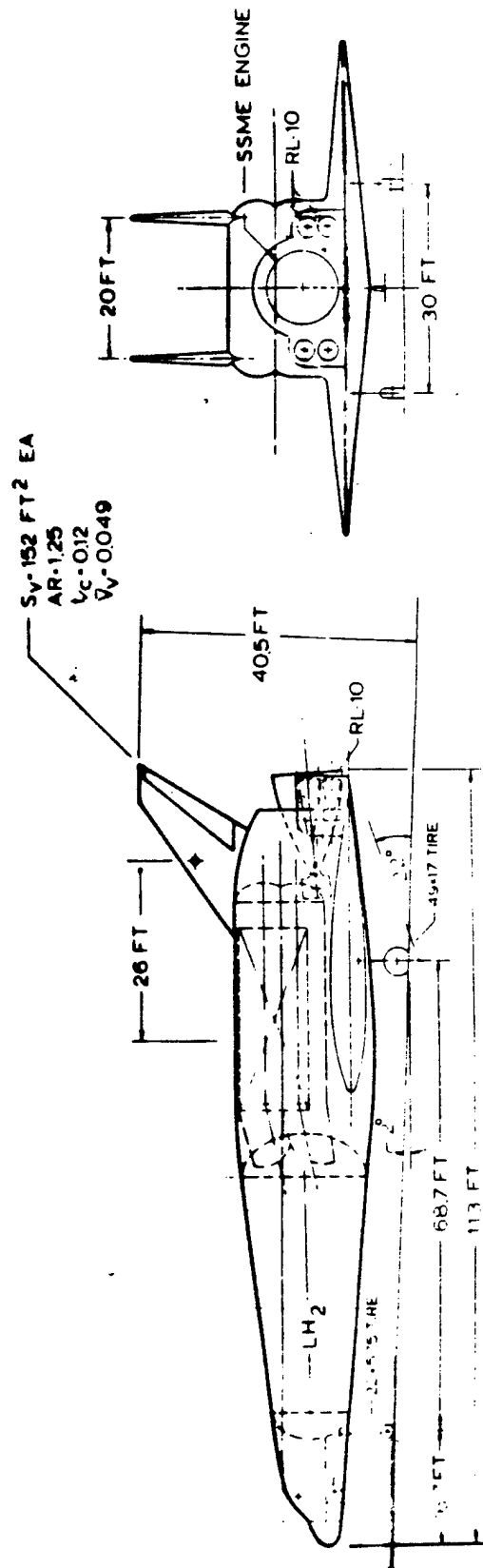

## BOEING PROPRIETARY

ORBITER KEY CHARACTERISTICS  
(MODEL 896-111, CONCEPT B-1)

The manned (2 crew) reusable upper stage shown on the opposite page utilizes an uprated SSME rocket engine (112 percent max rated), plus (4) advanced RL-10 engines (200 percent) and  $L_0_2/LH_2$  propellants to provide the necessary impulse to obtain orbital velocity after staging at 3000 ft/s.

The low planform reentry aerodynamic loading (22 to 27 lbs/ft<sup>2</sup>) results in operating temperatures that allow the use of titanium alloys on the upper surfaces and superalloys on the lower surface. This results in the capability to use a structural concept consisting of aluminum brazed titanium honeycomb on the upper surfaces and brazed superalloy (Rene'41 and INCO 718) honeycomb on the lower surface of the liquid hydrogen (body) and liquid oxygen wing tanks. The honeycomb systems are brazed in a vacuum with sealed core. Their low conductivity at cryogenic temperatures is such that fuel boil-off rates are within acceptable levels for ground hold. The use of these structural systems provides for a fully reusable, durable, nondamage sensitive, all weather operation airframe.

The unobstructed payload bay is 11 ft in diameter by 21 ft long and access is obtained through full length doors on the upper body surface. Since the rocket engines on both the booster and orbiter are used during the boost phase, a propellant cross feed system is required to keep the orbiter propellant tanks full at the time of staging.

# Orbiter Key Characteristics

MODEL 896-111, CONCEPT B-1

**NAVIGATION AIDS:** IMUs;

TACTICAL AIR NAVIGATION (140,000 FT--19,000 FT (12-13' NM RANGE FROM LANDING)  
 MICROWAVE SCAN BEAM LANDING SYSTEM (FROM 18000 FT, 12-13 NM RANGE)  
 AIR DATA SYSTEM (BELOW M.3)  
 RADAR ALTIMETER (BELOW 9000 FT.)

**GUIDANCE NAV. & CONTROL:**

MANUAL AND AUTO FLIGHT CONTROL  
 IMUs & NAV, INITIALIZES AT LAUNCH WTR LAUNCH PAD POSITION  
 RATE GYROS ON ORBITER & ACCELEROMETER ASSEMBLIES  
 2ND STAGE GUIDANCE CLOSED LOOP TO MECO TARGET

**THERMAL CONTROL ACCOMPLISHED BY GSE UNTIL LAUNCH, THERMAL SOAK FROM LAUNCH TO 140,000 FT, WATER SPRAY BOILERS--FREON LOOP FOR FLIGHT ABOVE 140,000 FT. AMMONIA BOILER--FREON LOOP FOR REENTRY BELOW 140,000 FT.**

**ENVIRONMENTAL CONTROL:** REDUNDANT O<sub>2</sub> & N<sub>2</sub> SUPPLY BOTTLES  
 FAN AIR/H<sub>2</sub>O SEPARATORS

**AVIONICS:** COMPUTER PROCESSOR UNITS INPUT/OUTPUT PROCESSORS

MEMORY MODULES, REMOTE SWITCHING TO REDUCE WIRING TO/FROM COCKPIT

COMMUNICATIONS: Ku BAND DOWNLINK AND TDRSS LINK

TELEVISION: PAYLOAD BAY & FORWARD GEAR WELL FOR LANDING; COCKPIT

● THERMAL PROTECTION

● HOT STRUCTURE

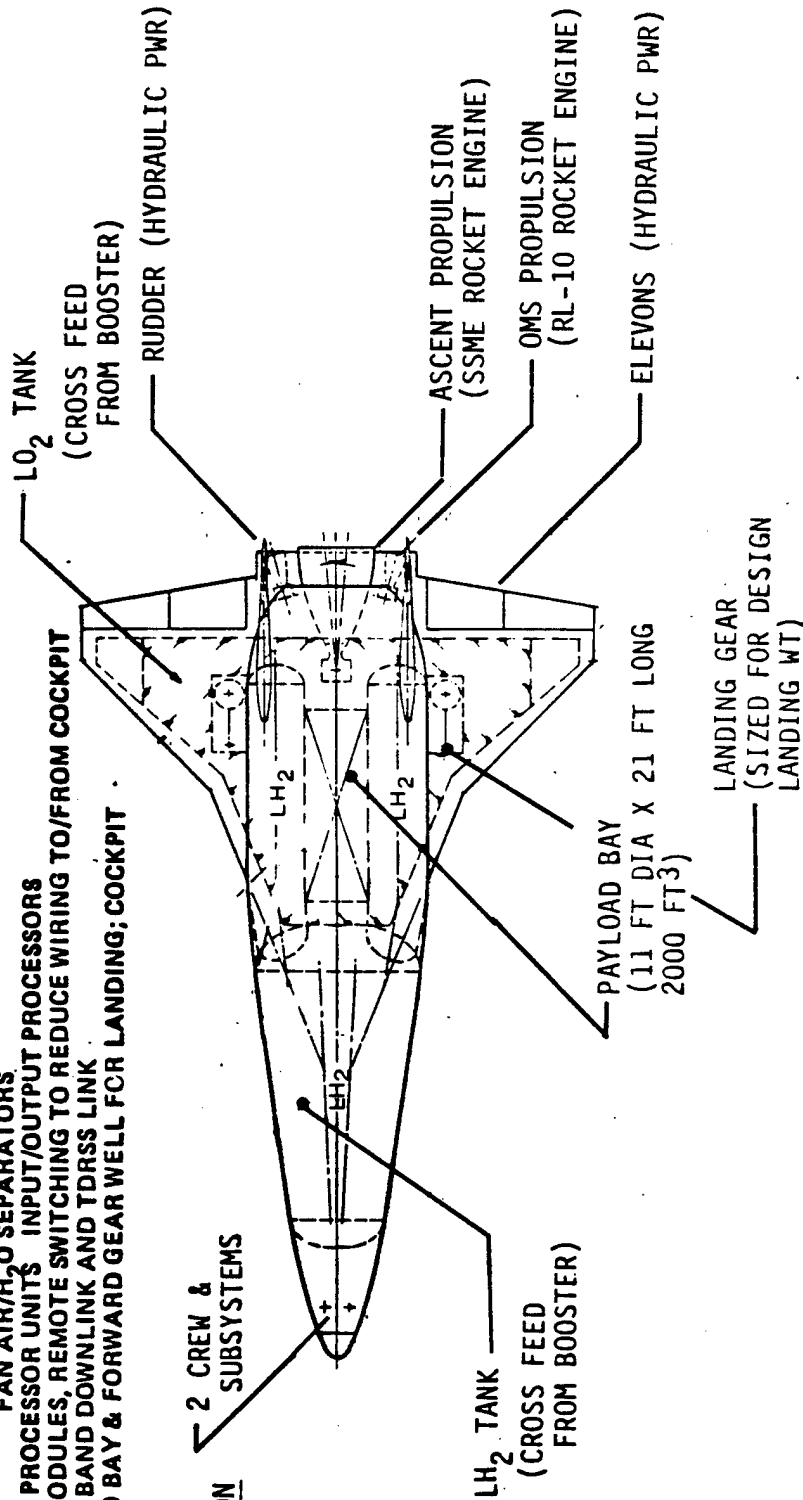



TAV ORBITER INBOARD PROFILE  
(MODEL 896-111, CONCEPT B-1)

The orbiter inboard profile is shown on the opposite page. The major subsystems are noted and their locations shown. During Phase II, detailed subsystem selection and installation features will be investigated.

# BOEING PROPRIETARY TAV Orbiter Inboard Profile

MODEL 896-111 , CONCEPT B-1

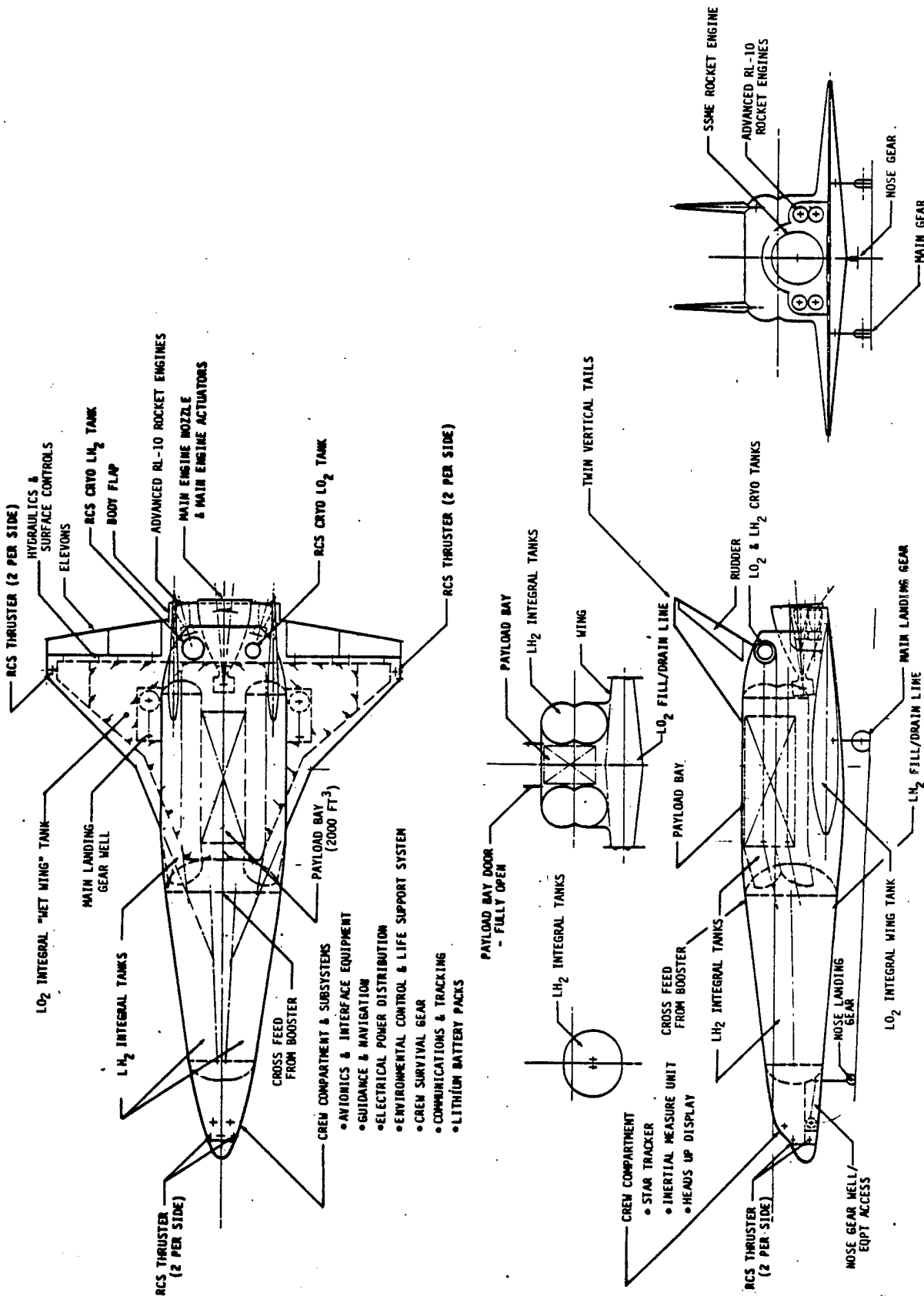

## BOEING PROPRIETARY

### STRUCTURAL ARRANGEMENT ORBITER MODEL 896-111

#### BODY

Primary structure is two deep fore and aft aluminum honeycomb beams which serve as payload bay walls, thrust structure to the forward fuselage, and booster attachment load distributors.

At the forward end of these beams is a bulkhead, built integrally with the LH<sub>2</sub> tanks, which has two booster attachment strong-points built in, and is flexibly attached to the wing front spar. At the aft end of the beams is a similar bulkhead, again with two booster attachment points, which acts as thrust distributor and attachment point for the vertical tails. It is rigidly attached to the wing main spar.

The forward LH<sub>2</sub> tank is of double bubble construction with vertical diaphragm, and carries at its forward end the nose fuselage, comprising equipment bay, a.c.s. bay, nose gear bay, crew capsule and refractory nose cone. The LH<sub>2</sub> saddle tanks are of double-bubble form with horizontal diaphragm. They are flexibly restrained at the rear bulkhead, and supported and faired along their length by corrugated panels from payload bay and wing. The LH<sub>2</sub> tanks are cross-fed from the booster during the boost phase.

#### WING

The wing, which serves as LO<sub>2</sub> tank, is a hot multispar truss type structure with wavy spar webs for fuel containment. The wing is link supported from the body to absorb thermal transients, except at the rear bulkhead and rocket thrust structure. The main landing gear is wing mounted, and retracts backwards into a thermally protected bay between the ribs. The leading edge is of refractory material and incorporates slip joints to minimize thermal effects.

The hydraulically operated control surfaces are of built-up sandwich construction, with materials tailored to the expected thermal profile.

The wing tank is cross-fed from the booster during the boost phase.

#### VERTICAL TAILS

The vertical tail structure of titanium sandwich construction is attached to the rear bulkhead and has a diagonal bracing strut to transmit lateral loads. The fin leading edge is again of refractory materials, with thermally compatible slip-joints.

The split rudder surfaces are of titanium sandwich construction. Hydraulically powered, they double in function as air-brakes.

# Structural Arrangement

ORBITER MODEL 896-111 (B-1)

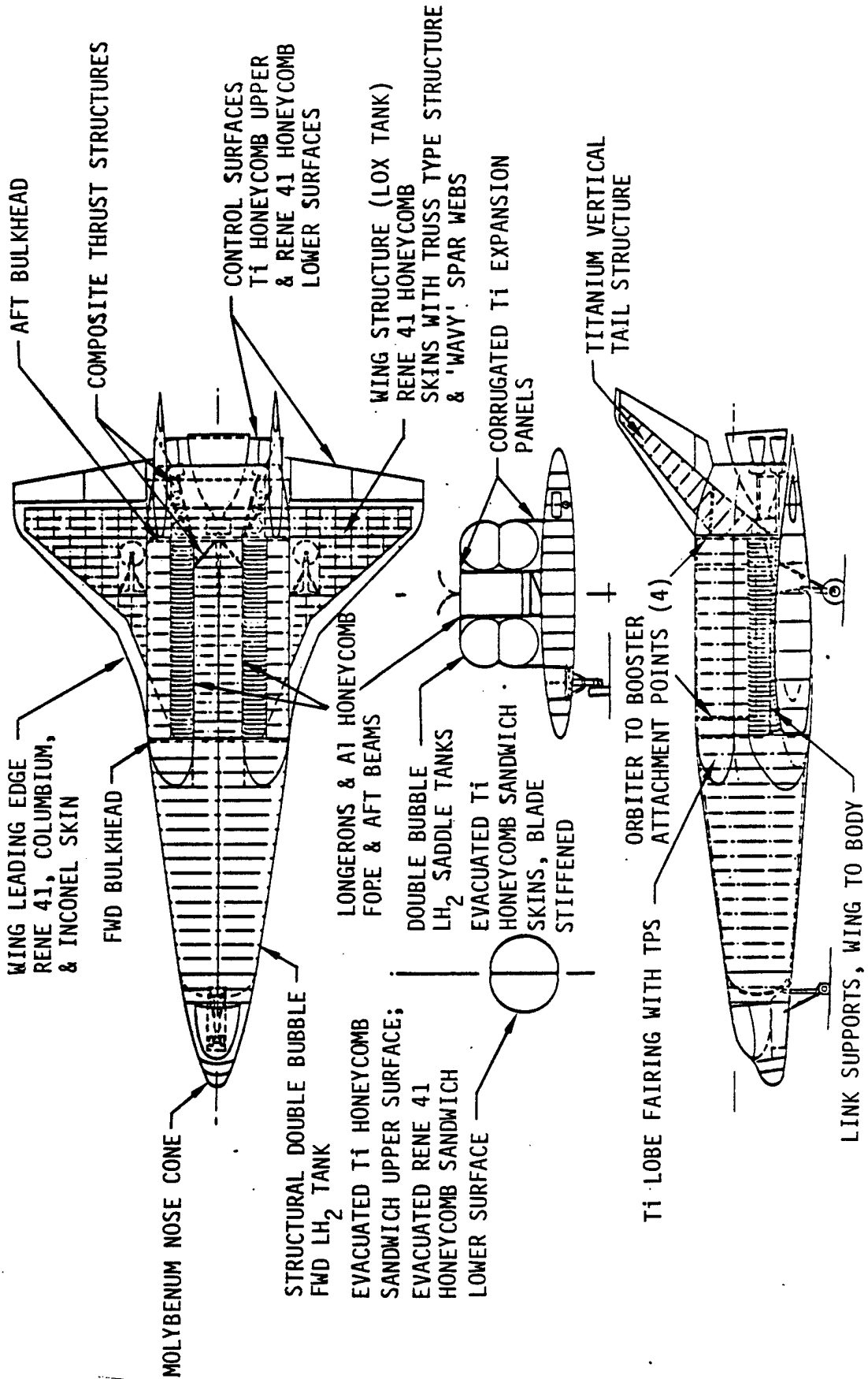

BOEING PROPRIETARY

ORBITER WEIGHT DESCRIPTION MODEL 896-111 (CONCEPT B-1)

The accompanying group weight statement is computer generated and consistent with furnished structural and subsystem definitions. Component and subsystem weight trending data were developed independently from a variety of references and then combined into a weight estimating computer program. A brief discussion of the group weight statement by section follows.

The body consists of four basic sections, nose, fuel tank, payload bay and base skirt. The nose includes a crew compartment (1890 lb) and nose gear installation provisions (0.25 percent of design landing weight). Payload bay structural weights were defined by parametric analyses. Payload bay insulation is included with the heat protection group. Base skirt weight includes primary structure, fairing, base heat shield/thrust structure and a body flap.

Published RASV wing weights were scaled to allow for geometry variations using airplane methods defined in D6-15095TN. Vertical fin plus attachment weight was estimated at approximately 8.5 lbs/ft<sup>2</sup> of projected planform area.

Landing gear weights were estimated at 3.1 percent of design landing weight (full payload). This value assumes a free fall type gear with advanced structural material and improved tire technology.

The heat protection group includes insulation provisions for equipment bays, main gear wheel wells, actuators, wing RCS bays, and the payload bay.

The total propulsion group consists of the rocket engines, engine accessories, propellant feed, RCS inerts (L02/LH<sub>2</sub>) and combined OMS/RCS/APU tankage. Propellant feed system weights are based on empirical correlations and include a cross feed system. RCS inerts were estimated at 73 percent of total usable RCS propellant weight. Rocket engine and their accessory weights are identified separately in the group weight statement.

Equipment weights are defined at the subsystem level. Weight estimating equations were defined individually for each subsystem utilizing Level I aircraft weight estimating procedures. Prime power (APS) weights were estimated assuming L02/LH<sub>2</sub> fueled APUs. The hydraulic and surface control subsystem weights were based on a 8000 psi hydraulic system.

A growth margin of ten percent of estimated dry weight excluding developed rocket engines and accessories weight is included in total orbiter inert weight.

BOEING PROPRIETARY

# Orbiter Group Weight Statement

MODEL 896-111, CONCEPT B-1

D180-27669-4

83

		<u>WEIGHT-LBS</u>			<u>WEIGHT-LBS</u>
<b>BODY</b>		(28154)	<b>MISSION B</b>		
o NOSE & CREW COMPT.		4070	POLAR LAUNCH (SUBORBITAL)		2180
o LH2 TANK		8900	EAST LAUNCH (ORBITAL)		1100
o PAYLOAD BAY		3970			(8450)
o PRIMARY STRUCTURE & FAIRINGS		10644	<b>EQUIPMENT</b>		
o BODY FLAP		570	AVIONICS		2180
<b>WING GROUP</b>		(15900)	ENVIRONMENTAL CONTROL		933
VERTICAL TAIL		(2570)	PRIME POWER		927
LANDING GEAR		(3170)	HYDRAULICS		1279
HEAT PROTECTION		(2080)	ELECTRICAL		1554
ASCENT PROPULSION		(12287)	SURFACE CONTROLS		477
			CREW PROVISIONS		(6280)
o ENGINE (ADV. SSME)		6900	<b>GROWTH MARGIN</b>		
o ENGINES (RL-10)		1300	TOTAL EMPTY		80094
o ACCESSORIES.		2117	RESIDUALS & RESERVES		1755
o GIMBAL & HYDR SUPPLY	792		CREW & CARRYON		480
o HEAT SHIELD	560		TOTAL LANDING (W/O PAYLOAD)		82031
o HELIUM SYSTEM	690		INFLIGHT LOSSES SYSTEMS & PROPULSION		3605
o PROPELLANT MANAGEMENT	25		RCS PROPELLANT (NOM.)		600
o HELIUM	50		OMS PROPELLANT (NOM.)		0
o FEED SYSTEM		1970	TOTAL INERT PROPELLANT, ASCENT		86236
TANKAGE & CONTROL (OMS, RCS & APU)		(633)			471200
RCS PROPULSION		(570)	TOTAL STAGE PAYLOAD		557436
			TOTAL		577500

NOTE: OW C.G. @ 0.72 BODY LENGTH  
 GW C.G. @ 0.76 BODY LENGTH

TAV BOOSTER INBOARD PROFILE  
(MODEL 896-111, CONCEPT B-1)

The booster inboard profile is shown on the opposite page. The booster's major subsystems are located and the orbiter is shown mated with the booster in the takeoff condition.

BOEING PROPRIETARY

# TAV Booster Inboard Profile

MODEL 896-111, CONCEPT B-1

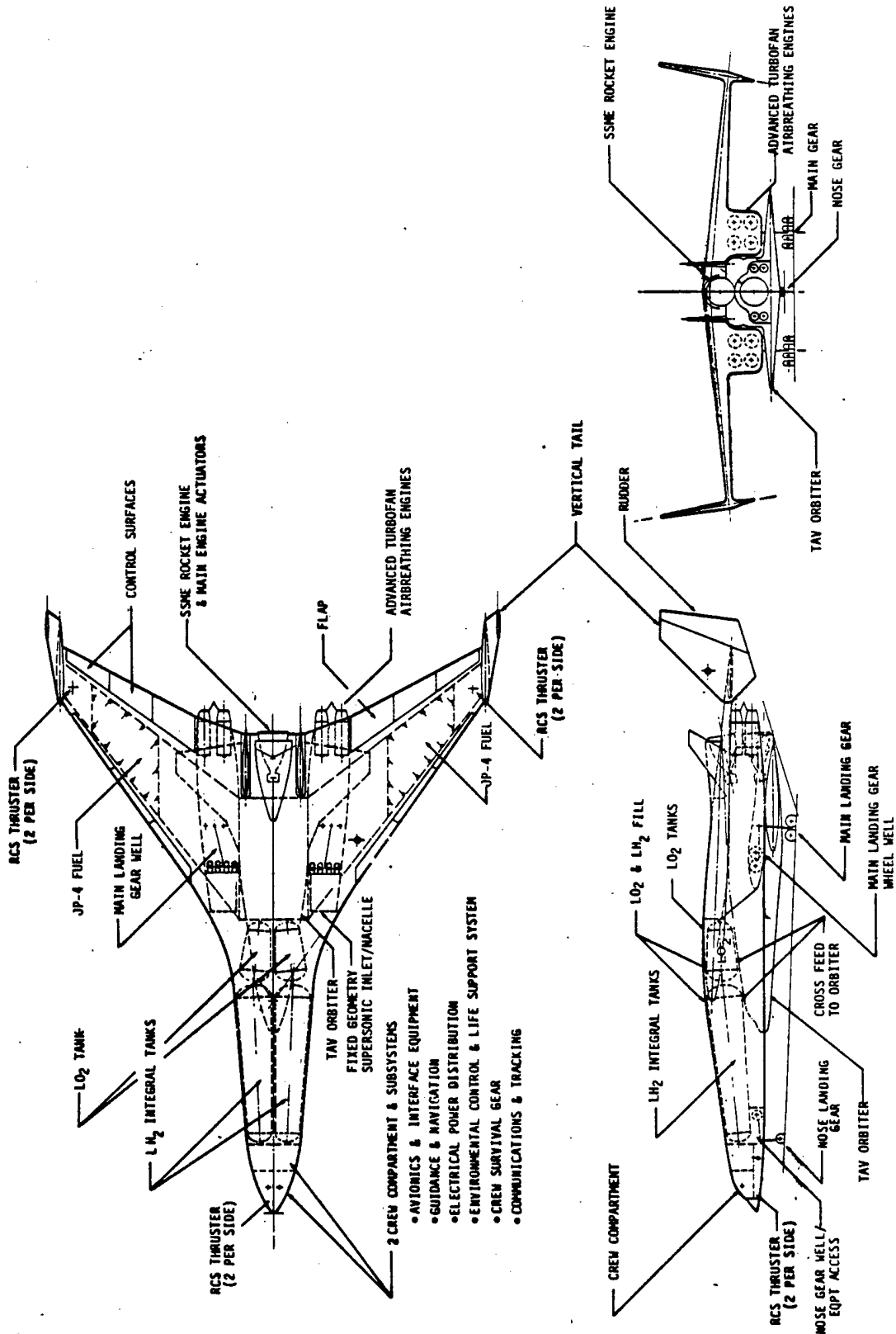



BOEING PROPRIETARY

TYPICAL ARRANGEMENT OF AIRBREATHING/ROCKET BOOSTER

This chart illustrates the general layout of Model 896-111 (Concept B-1) booster. The two-man crew and aircraft subsystems are located in the forward body. The two cylindrical LH<sub>2</sub> fuel tanks are paired in the forward fuselage with the LO<sub>2</sub> tank pair located directly to the rear. The nose landing gear is located forward and below the LH<sub>2</sub> tankage. The nacelles, with fixed supersonic inlets, are located outboard of the body cavity which accommodates the orbiter. The eight wheeled main landing gear is integral with the nacelle and retracts forward into the lower nacelle when stowed. The wings are mounted high on the fuselage to provide clearance with the underslung orbiter. Wing tip mounted verticals are used to provide directional stability. A single SSME rocket engine is used during boost phase and is located on aircraft centerline at the wing trailing edge.

# Typical Arrangement of Airbreathing / Rocket Booster

D180-27669-4

87

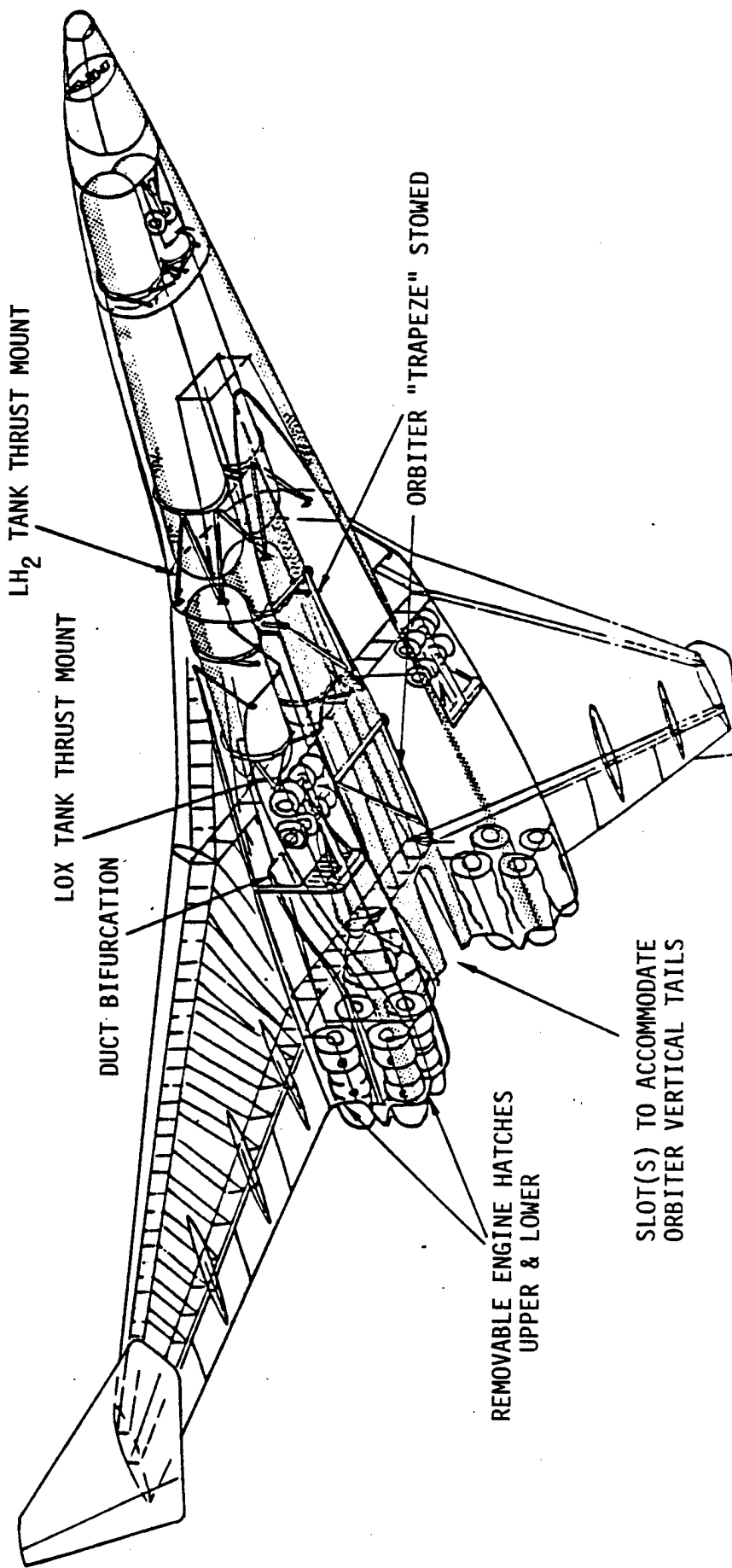

THIS PAGE INTENTIONALLY LEFT BLANK

BRIEF STRUCTURAL DESCRIPTION  
AIRBREATHING BOOSTER MODEL 986-111BODY

Body structure is semimonocoque with graphite/polyimide honeycomb sandwich skin panels, frame supported. Two deep aluminum honeycomb beams form the sidewalls of the orbiter recess, carrying twin lower-body longerons and providing vertical shear capability. Attached to the wing by the wing to body longeron, these beams extend aft of the wing and form the inboard structure of the airbreathing engines mounting structure. Within the body cavity, the beams carry the pair of trapezes which control the relative movement of the booster and orbiter, to ensure clean separation.

The other engine supports are provided by vertical beams attached below the wing, the center one acting as a duct splitter over its forward portion, the outboard one forming the nacelle wall. Further structure is provided by the horizontal duct splitter, which continues aft as a firewall separating the upper and lower engine pairs, and providing lateral shear stiffness. Engine removal is effected through individual hatches on the top and bottom surfaces of the nacelle. Removal of any or all of the hatches does not affect the structural integrity of the engine support structure.

The cylindrical LH<sub>2</sub> tanks are paired in the forward fuselage, and are link-supported inside the body monocoque. Fore and aft loads are taken by a thrust structure joining the aft tank ring to a body bulkhead which serves to separate the fuel and oxidizer bays, and also forms a manufacturing joint. Aft of this is the LOX tank pair, also link supported, with a thrust structure to the front spar of the wing. Forward of the LH<sub>2</sub> tanks are the nose landing gear bulkhead, the equipment and ACS bays, and the crew compartment and capsule.

**BOEING PROPRIETARY****BRIEF STRUCTURAL DESCRIPTION (Cont'd)  
AIRBREATHING BOOSTER MODEL 986-111**WING

The high-mounted wing carries the four orbiter attachment points, two each on the front and rear spar center sections. The four-spar wing has graphite/polyimide honeycomb sandwich skins with integral spar caps. Stringers, spar webs, and ribs are graphite/epoxy co-cured. The wing leading edge is a built-up titanium structure with provisions for thermal stress relief. Control surfaces are of graphite epoxy honeycomb.

VERTICAL TAILS

The vertical tails are of similar construction to the wing. The possibility of using split rudders is being studied. This will enhance directional stability in slip-flow conditions by forming wedge-type vertical tail surfaces.

LANDING GEAR

The main landing gear comprises two struts, each carrying an eight wheeled truck, retracting forward into the nacelle lower surface. Vertical loads are reacted to the wing structure by a bulkhead spanning between the inboard beams and the outboard nacelle wall.

The nose landing gear is mounted on the bulkhead ahead of the LH<sub>2</sub> tanks, and retracts rearwards to lie below the tanks. Provision is made for emergency extension should the hydraulic system fail. Because of the wide spread between takeoff and landing weights, an adaptive two-stage oleo design is proposed for all three elements of the tricycle landing gear.

BOEING PROPRIETARY

# Structural Arrangement

AIRBREATHING BOOSTER MODEL 896-111 (B-1)

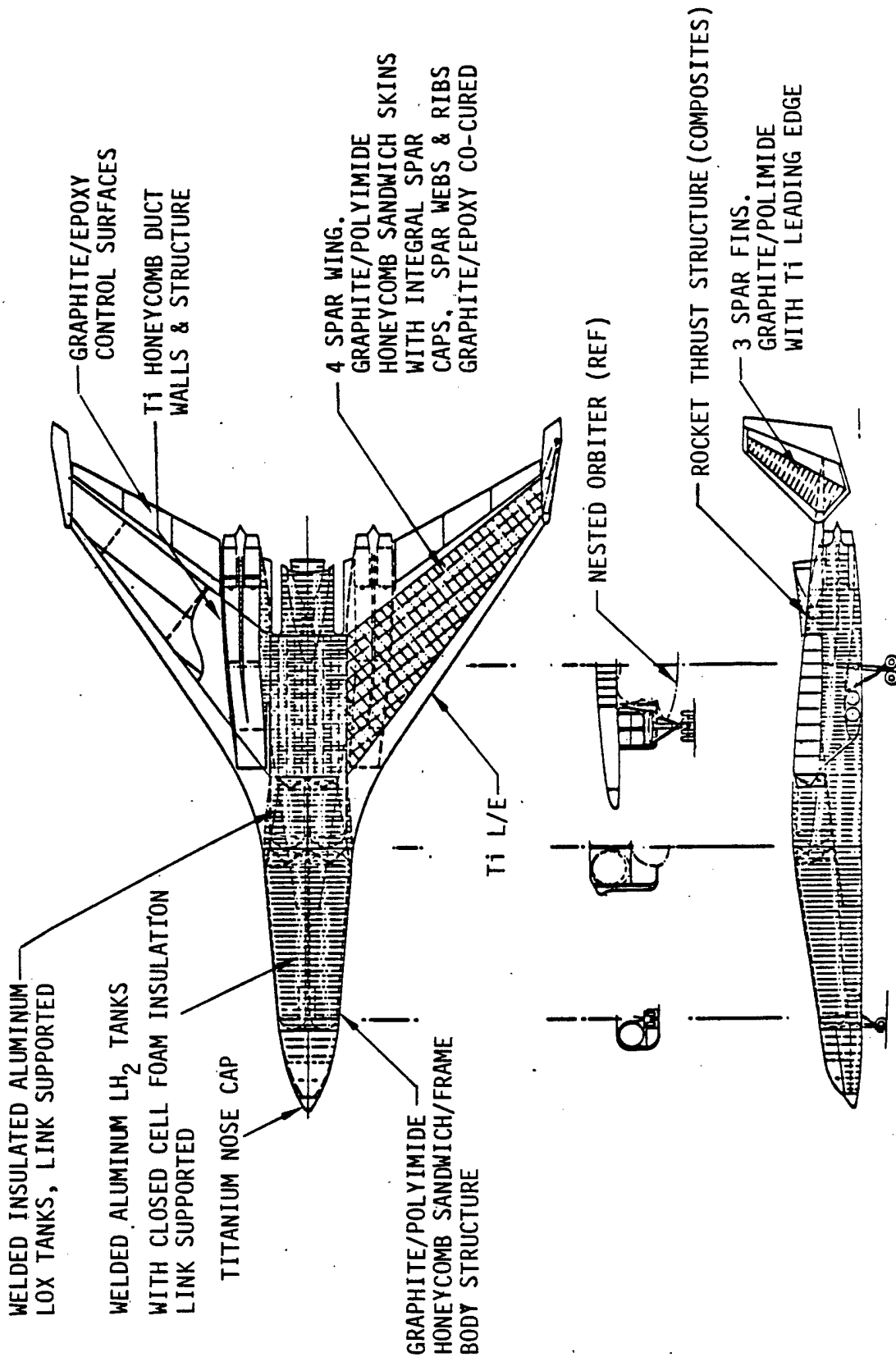

## BOEING PROPRIETARY

## BOOSTER GROUP WEIGHT STATEMENT, MODEL 896-111

Model 896-111 Booster weight and mass property data were estimated using a Boeing developed preliminary design weight estimating computer program (PDWTS). Mass properties estimating methods incorporated into PDWTS were derived from Level I methods contained in Boeing document D6-15095TN. The methods are based upon data from a large spectrum of existing military and commercial airplanes. A schematic of this program is presented in the Concept Analyses and Trade Studies Section.

For the Model 896-111 booster, PDWTS program data had to be supplemented with a mass property description of the cryogenic systems, payload support plus separation provisions, and crew accommodations consistent with recovery environment. These items account for approximately 16 percent (47,700 lb) of the booster operating weight. Developed detail for the cryogenic and crew systems is consistent with weight detail developed for the orbital stages. Payload support and separation provisions weight allowance were estimated from Reusable Systems historical data. Weight data shown are consistent with structural definitions and a 1995 IOC.

Payload accounts for 44.4 percent of vehicle gross weight, rocket propellant and airbreather fuel accounts for 32.9 percent and the remaining 22.7 percent is operating weight (OW).

Resulting wing unit weights are approximately 10.5 lbs/ft<sup>2</sup> based on total wing planform. The vertical fins are 30 percent rudder and average 6.43 lbs/ft<sup>2</sup> of planform. Body unit weight including cryo provisions is 5.3 lbs/ft<sup>2</sup>. Cryo provisions are approximately 29 percent of the body weight.

Landing gear weights are based on a maximum landing weight of 298,000 lbs. The main landing gear accounts for 29,219 lbs of the 32,372 lbs total. The running gear is 55.5 percent of main gear weight and 45.4 percent of nose gear weight. Structure weight is approximately 30 percent for both gears and controls makeup the remainders.

The reaction control system weights are based on a L<sub>02</sub>/LH<sub>2</sub> propellant concept having an ISP/VAC = 420 sec and a low chamber pressure of 150 PSI.

BOEING PROPRIETARY

# Booster Group Weight Statement

MODEL 896-111, CONCEPT B-1

D180-27669-4

93

	W.T.-LBS	BODY STA	PER CENT MAC
*****			
WING	94258.*	2076.*	
VERTICAL TAIL	9257.*	2712.*	
BODY(INCL. CRYO TANKAGE)	57233.*	1124.*	
ALIGHTING GEAR	32372.*	1754.*	
NACELLE OR ENG SECTION	3111.*	2338.*	460.* 320.*
AIR INDUCTION SYSTEM	9027.*	1774.*	208.* 2020.*
CREW COMPARTMENT	1100.*	320.*	1000.* 2338.*
PAYLOAD SUPT SYS + FAIRING	8300.*	2138.*	100.* 320.*
TOTAL STRUCTURE	214656.*	1785.*	500.* 2140.*
*****			
ENGINE + ACCESSORIES	31520.*	2338.*	4780.* 1650.*
STARTING + CONTROL	1000.*	1813.*	7048.* 1688.*
FUEL SYSTEM	3339.*	2020.*	295306.* 1840.17.9
ROCKET PROPULSION	12300.*	2060.*	
RCS INERTS	1100.*	1350.*	
TOTAL PROPULSION	49259.*	2214.*	
*****			
FLIGHT CONTROL	3741.*	2280.*	
AUXILIARY POWER PLANT	986.*	480.*	1300516.* 1970.21.8
INSTRUMENTS	1020.*	325.*	
HYDRAULIC + PNEUMATIC	8274.*	2109.*	
ELECTRICAL	2567.*	1395.*	
AVIONICS	1998.*	1300.*	
FURNISHINGS + EQUIP	2815.*	320.*	
AIR COND + ANTI-ICING	1423.*	1427.*	
LOAD + HANDLING	1520.*	2140.*	
TOTAL FIXED EQUIPMENT	24343.*	1608.*	
*****			
WEIGHT EMPTY	288258.*	1844.*	
*****			

\*\*\*\*\*  
 \* NOSE STATION. 200. IN \*  
 \* WING MAC 770. IN \*  
 \* LEMAC 1702. IN \*  
 \* BODY LENGTH 1512. IN \*  
 \*\*\*\*\*



BOEING PROPRIETARY

#### BOOSTER STRUCTURAL MATERIALS WEIGHT SUMMARY

The accompanying chart presents the structural material breakdown for the Model 896-111 booster stage. Line item breakdowns are shown for the five basic structural components. Body weight was modified to include the crew compartment and payload support line items.

In conjunction with the development of the PDWTS program weight reduction factors were compiled at a item level to allow weight variation with IOC date (the development of advanced structural concepts). Structural concepts coinciding with the 1995 IOC and the established booster material descriptions were utilized to develop the material breakdown shown. Developed PDWTS data for the 1995 IOC and conventional aircraft were expected to deliver approximately 54.5 percent graphite/polyimide. These data yield a value slightly less (52.7 percent). The aluminum cryogenic tank concepts and high strength material portions of payload support provisions reduce the composite percentage.

# Booster Structural Materials Weight Summary

MODEL 896-111, CONCEPT B-1

COMPONENT	GRAPHITE-POLYIMIDE		ALUMINUM ①		TITANIUM		STEEL	② OTHER	TOTAL *
	HONEYCOMB SANDWICH ③	CONVENTIONAL STRUCTURE	HONEYCOMB SANDWICH	CONVENTIONAL STRUCTURE	HONEYCOMB SANDWICH	CONVENTIONAL STRUCTURE			
WING	4244 (45%)	28280 (30%)		9426 (10%)		9426 (10%)		4712 (5%)	94258
VERTICAL TAILS	4629 (50%)	2315 (25%)		1389 (15%)		462 (5%)		462 (5%)	9257
BODY AND CRYO TANKS	14990 (22.5%)	13279 (20%)		21068 (31.6%)	690 (1.0%)	4528 (6.8%)	4455 (6.7%)	7621 (11.4%)	66631
LANDING GEAR		1618 (5%)		6474 (20%)			12950 (40%)	11330 (35%)	32372
ENGINE SECTION	3730 (30.7%)	1860 (15.3%)		1177 (9.7%)		4824 (39.7%)		547 (4.6%)	12138
TOTAL STRUCTURE*	65763 (30.6%)	47352 (22.1%)		39534 (18.4%)	690 (0.3%)	19240 (9.0%)	17405 (8.1%)	24672 (11.5%)	214656 (100%)

① 75% OF TOTAL ALUMINUM IS ADVANCED HIGH STRENGTH

② RUBBER, SEALANT, PAINT, F/G, ETC.

③ HONEYCOMB SURFACE PANELS AND SOME INTERNAL PANELS: GRAPHITE-POLYIMIDE FACE SHEETS AND HFT (3 LB/FT<sup>3</sup>); CORE WEIGHT = 1.3% LB OF TOTAL G/E HONEYCOMB

\* TOTAL STRUCTURE WT/OPERATING WT = 0.727

## BOEING PROPRIETARY

## TWO-STAGE LAUNCH SYSTEM PAYLOAD PERFORMANCE

Performance estimates are presented for Models 896-111 (Concept B-1), booster and hot structure orbiter, for the design goal and Missions A through D. Model 896-111 achieved the design goal of 20,000 lbs payload in a once-around polar suborbit. At 55° inclination, Mission C, Model 896-111 is capable of delivering 27,800 lb once-around, and over 32,000 lb at 32° inclination. The 500,000 ft circular orbit performance Missions A and B are shown utilizing a Hohmann transfer. Payload penalties of 3500 lb and 3200 lb are realized for 90° and 55° orbits, respectively, if orbit is achieved via direct ascent.

For Mission D, a nominal rendezvous V of 900 ft/s was used as a benchmark requirement. With this requirement set, Model 896-111 provides 10,000 lb of payload and specialized docking equipment capability. Rendezvous V capability can be traded for payload depending on mission requirements. Provisions for circularizing and deorbit burns, additional tankage, systems, reserves, and residuals have been made so that payload and V figures shown are usable quantities.

Additional performance estimates are presented for an alternate orbiter concept, Model 896-112. The -112 orbiter has been designed to be fully compatible with the -111 booster while employing the proven, shuttle-type reusable surface insulation. Model 896-112's performance is approximately 25 percent lower than -111 in delivering 16,050 lbs into a once-around polar orbit. The basic reason for the payload reduction is due to propellant volume limitations on the orbiter.

Further performance improvements have been realized through POST (Program to Optimize Simulated Trajectories) trajectory optimization. For Model 896-111, once-around payload performance increased from 32,150 lb to 34,500 lb for 32° inclination and from 20,000 lb to 23,000 lb for 90° inclinations. Comparable improvements are expected for Missions A through D. Details of the optimized trajectory performance including POST input and output files are contained in Appendix B.

# Two-Stage Launch System Payload Performance

MODEL 896-111, CONCEPT B-1

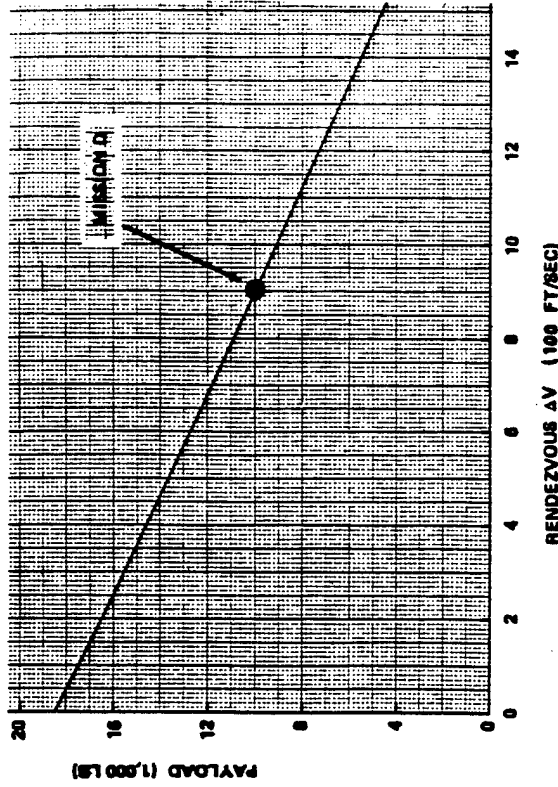

△ POST optimized performance for once-around missions.

Staging occurs at H=103,800 ft  
V=3,280 ft/s  
γ=22 deg

See Appendix B for details.

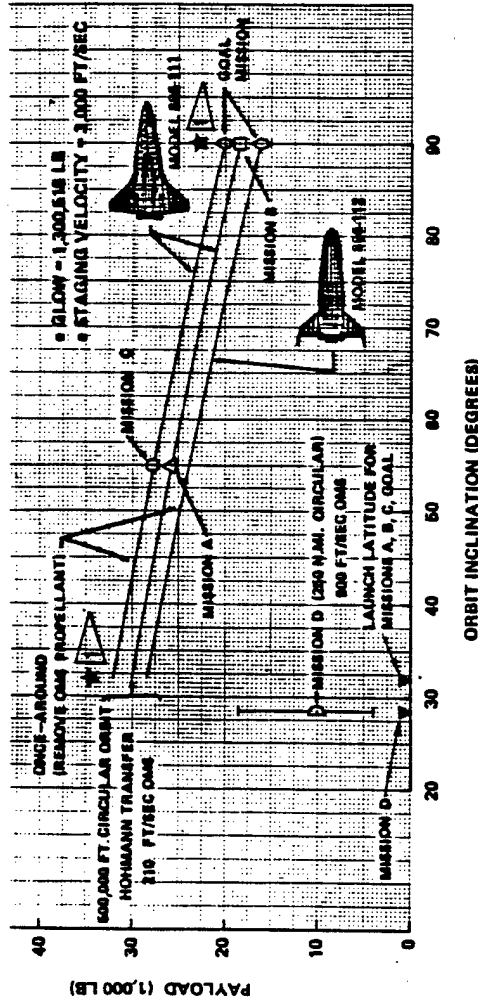

**MISSION A:** Launch from 32° N latitude to a 500,000 ft circular 55° orbit, return-to-launch-site after one orbit.

**MISSION B:** Launch from 32° N latitude to a 500,000 ft circular 90° orbit, return-to-launch-site after one orbit.

**MISSION C:** Launch from 32° N latitude to a 500,000 ft altitude once-around (suborbital) 55° inclination, return-to-launch-site.

**MISSION D:** Launch from 28.5° N latitude to a 250 N mi circular 28.5° orbit, rendezvous, dock with Space Station, return to CONUS within several orbits (mission duration less than 24 hrs). Mission D is not to be mission driver, but a tradeoff vs. payload capability.

ALTERNATE MISSIONS FOR FIRST STAGE AIRCRAFT  
(MODEL 896-111, B-1 CONCEPT)

A study was conducted investigating alternate uses for the first stage booster in order to maximize its utility and therefore become more cost-effective. The booster stage has a large cavity in the lower body which normally contains the orbiter. This cavity is approximately 12 ft deep x 27 ft wide x 110 ft long. The study involved looking at the transporting of "outsized cargo" which cannot presently be carried by existing military or commercial aircraft. Several different outsized-cargo missions are shown on the facing page and the range performance shown on the following page. Modifications to the booster are required to support the various cargo payload types and aerodynamic fairings are necessary to minimize aerodynamic drag penalties.

# Alternate Missions For First Stage Aircraft

CONCEPT B-1

**NOTE:**

747 FREIGHTER CAPACITY = (13) 8' X 8' X 20'

PLUS (5) 8' X 8' X 10' CONTAINERS

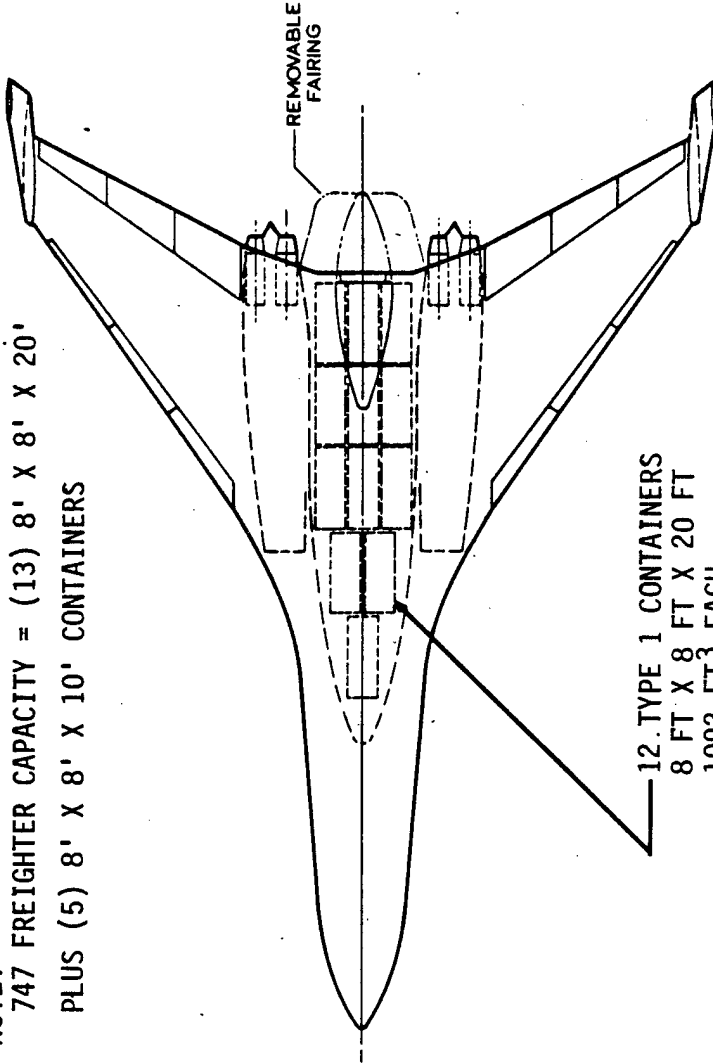

- TRANSPORTATION OF CONTAINERIZED CARGO
  - 12 TYPE 1 CONTAINERS
  - 131,000 LB P/L

- TRANSPORTATION OF "OUTSIZED" CARGO
  - SHUTTLE PAYLOAD CONTAINER (17 FT DIA X 96 FT LONG)
  - AFT B-1 BODY SECTIONS
  - XM-1 COMBAT TANKS (4) TANKS @ 130,000 LB EA.)
  - 767-200 FUSELAGE (17.5 FT DIA X 155 FT LONG)
  - SHUTTLE DROP TANK (27.5 FT DIA X 149 FT LONG)

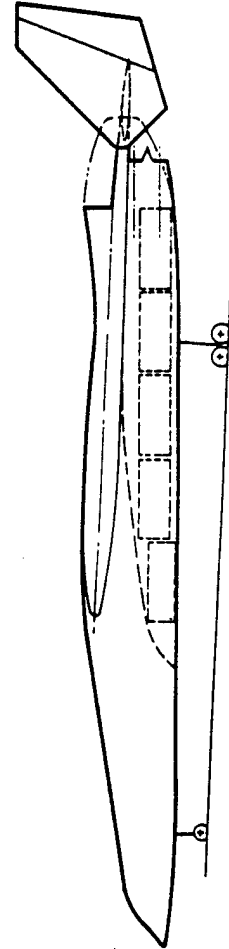
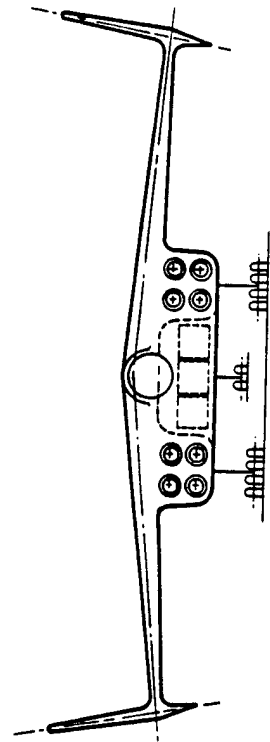

## BOEING PROPRIETARY

## BOOSTER PERFORMANCE, FERRY/ALTERNATE MISSION

Model 896-111 booster's large payload capacity could provide the flexibility required to be used in a variety of cargo/transport alternate missions. If the booster were used in this configuration the vehicle would be fitted with integral wing fuel tanks and reinforced landing gear for heavy weight landing. The OWE (operating weight empty) is increased to 361,000 lbs and the fuel capacity to 805,000 lbs through these modifications. This provides the capability to transport 600,000 lbs 1400 nmi. Alternate mission applications include the transport of

- o Four M-1 tanks 1800 nmi
  - o Twelve type 1 8 x 8 x 20 ft standard international air transport cargo containers 5300 nmi
- and outsized cargos of
- o B-1-B aft fuselage section 6250 nmi
  - o Shuttle payload and container
  - o Shuttle external tank
  - o Boeing 767-200 fuselage

The booster alone and booster/orbiter can also be ferried up to 4400 nmi depending on the type of base fairing installed.

# BOEING PROPRIETARY Booster Performance, Ferry/Alternate Mission

MODEL 896-111, CONCEPT B-1

GROSS WEIGHT = 1,300,000 LBS

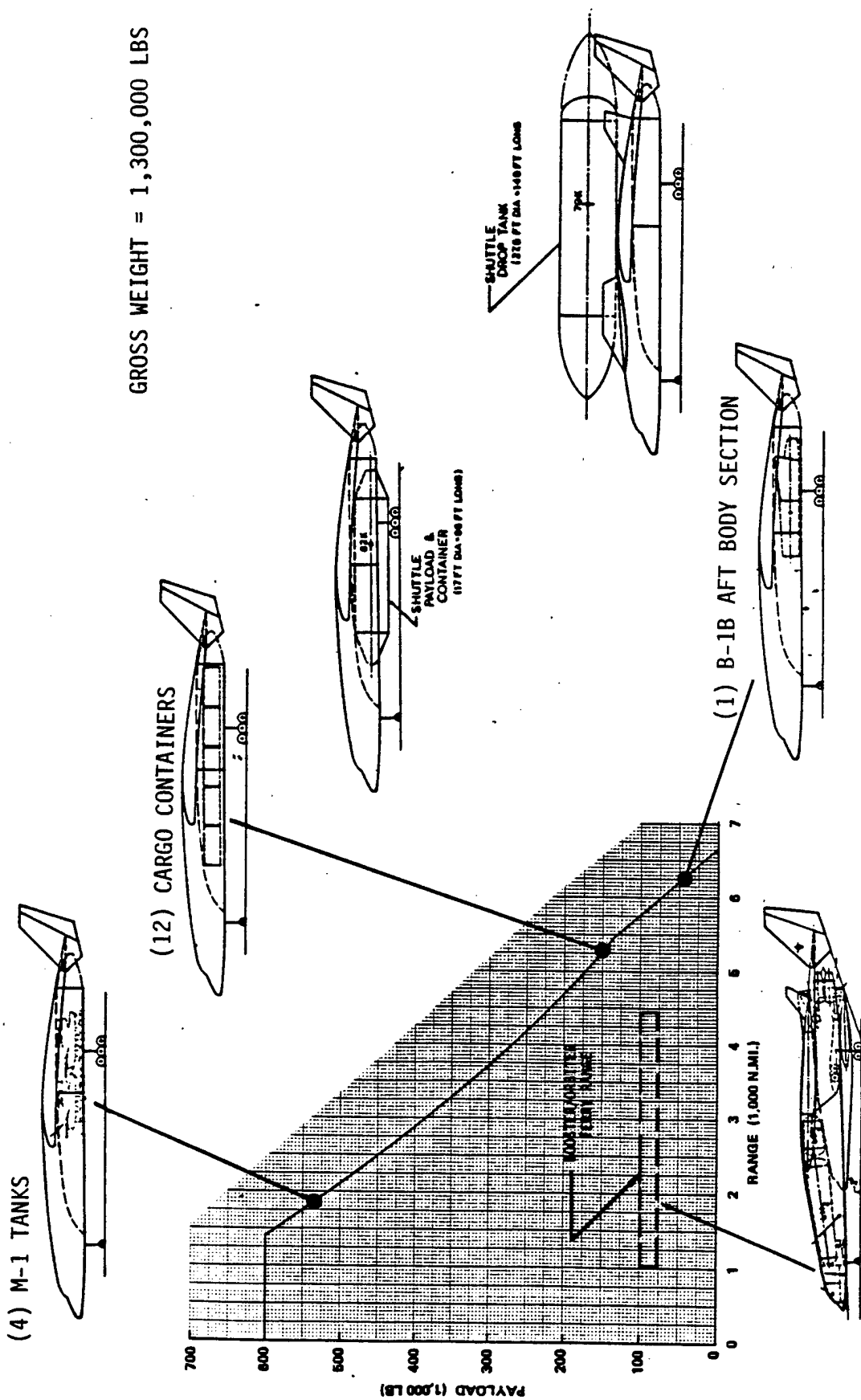



## BOEING PROPRIETARY

## TWO-STAGE HTO TAV BASING CONCEPT

A simplified basing concept for Concept B-1 is indicated. The vehicles would be joined and positioned on the alert pads. A LO<sub>2</sub>/LH<sub>2</sub> servicing facility is installed adjacent to the TAV pad to allow all cryogenic loading and replenishment to be controlled in one area. The alert pad would be located similarly in nature and concept as any military bomber alert pad (which allows close crew alert quarters, communication facility, and excellent access to the main runway).

After completion of the takeoff, climb and separation the booster would return to the base to be recycled for any necessary maintenance. The orbiter would be recycled following completion of its scheduled suborbital or orbital mission. The orbiter would be processed through a separate facility (not necessarily a separate building) to provide maintenance and payload integration, the latter being a significant activity. A separate monopropellant facility is visualized due to the hazardous nature of these systems. Future studies would identify benefits, costs, and risks of trading this separate complex against integrated systems and alternate propellants.

BOEING PROPRIETARY

# Two Stage HTO TAV Basing Concept

(B-1)

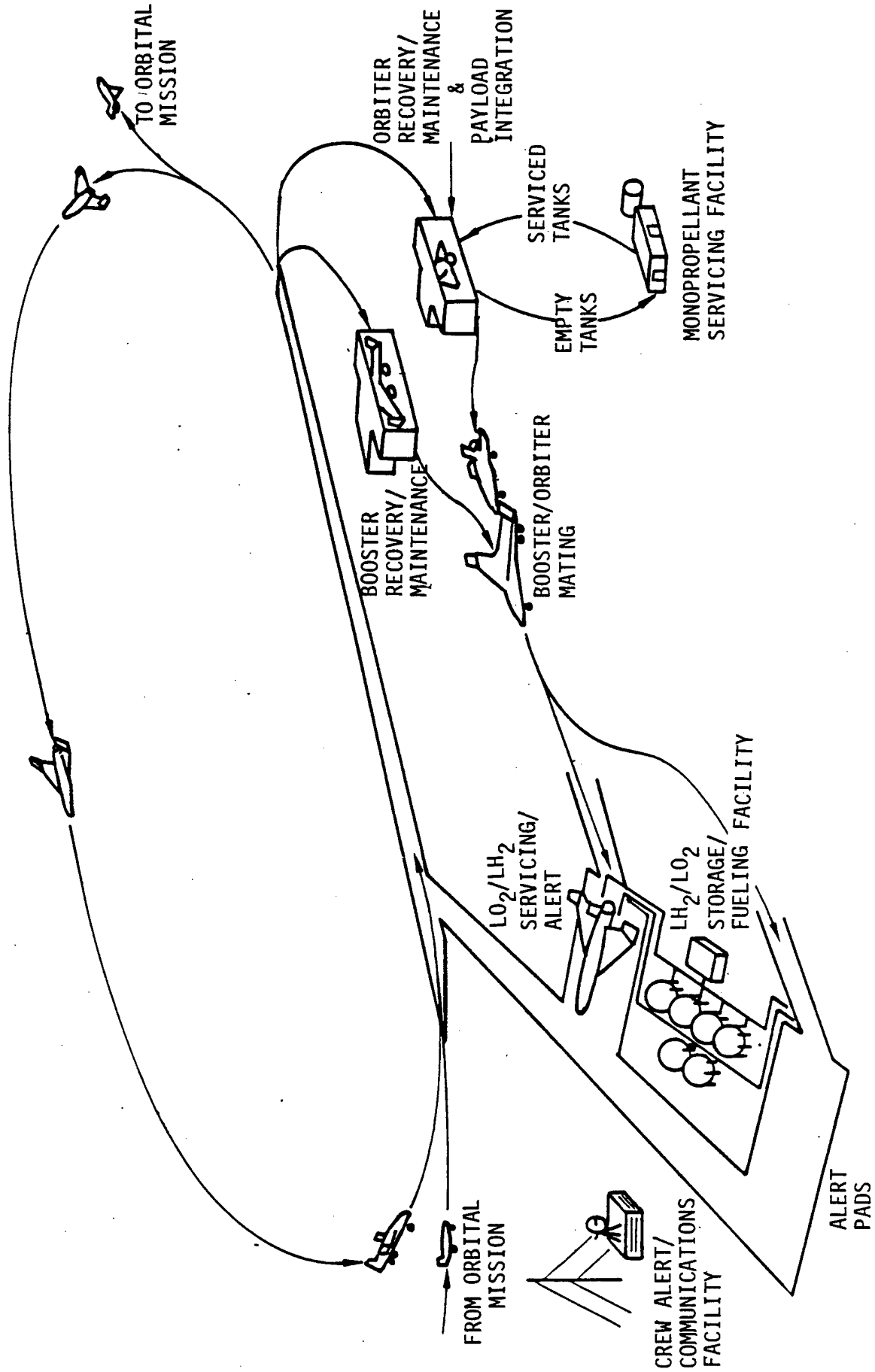

#### TAV TWO-STAGE HTO O&M FLOW DIAGRAM

The handling operations and maintenance (O&M) diagram shown was put together as a first step in identifying the O&M peculiar requirements. Each of the major functions is examined for vehicle, facility, and ground support equipment requirements in the following sheets.

The study reviewed the major considerations in placing an operational two-stage HTO TAV system on existing SAC bases as well as assessing the functional requirements for the vehicle, facilities and support equipment to enable quick response and rapid turnaround.

The major new element for an operational TAV system on a SAC base is a LH2 and L02 production, storage and delivery system. Other support resources in terms of facilities, support equipment, spares, personnel, training and technical data all require careful consideration but are well within the scope of a typical weapon system acquisition process.

BOEING PROPRIETARY

# TAV Two Stage HTO O&M Flow Diagram

CONCEPT B-1

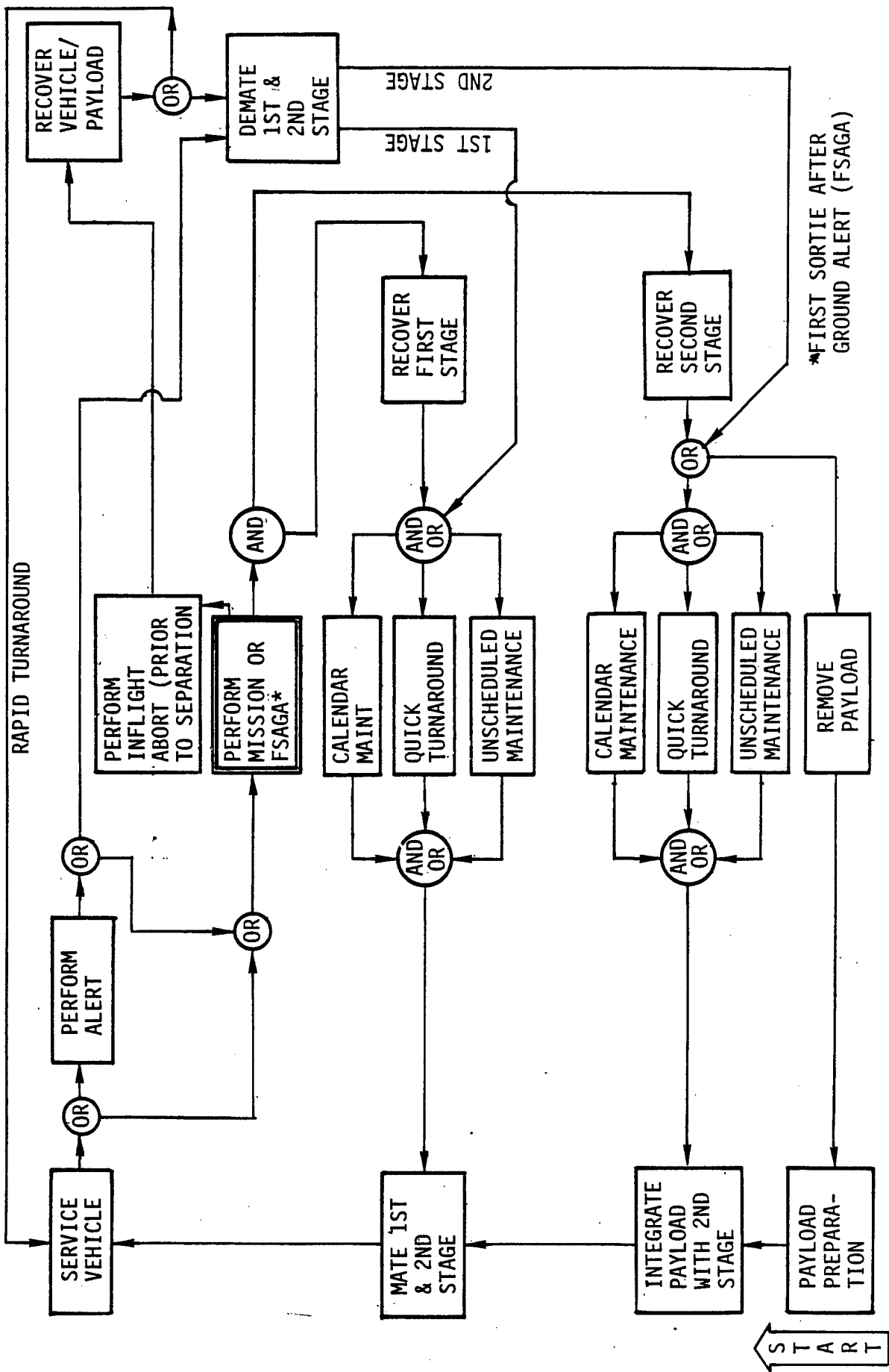

\*FIRST SORTIE AFTER GROUND ALERT (FSAGA)

## TURNAROUND ANALYSIS

The two mission/day requirement allows a turnaround time from approximately 12 to 22 hours depending on the number of orbits required to complete the mission. The two-stage HTO design goals needed for this kind of turnaround are as follows:

## a. Booster/Orbiter

- (1) A fully reusable structural system (no refurbishment between missions).
- (2) Self checkout, fault detection and isolation capability, including the payload.
- (3) A rapid means for purging and servicing mono-propellant systems.
- (4) A rapid means for servicing compressed gas, life support, and crew comfort systems.
- (5) A capability for quick replacement of wheels and brakes.
- (6) Minimum use of electro-explosive devices (EEDs) and ordnance devices.
- (7) Self-aligning features for rapid mating to the booster.
- (8) A capability for rapid chill down and servicing of LH<sub>2</sub> and LO<sub>2</sub> fuel systems.

## b. Support System

- (1) An LO<sub>2</sub> and LH<sub>2</sub> storage and servicing facility with sufficient volume and flow rates to quickly service the vehicle.
- (2) A well trained and well organized ground crew.
- (3) A dock or facility to accomplish post flight recovery and turnaround.
- (4) Adequate spares, technical data and technical services to correct system problems.

Booster/orbiter and support system will have characteristics that provide typical turnaround timelines. Mission No. 1 of the figure provides a turnaround timeline where Booster No. 1 and Orbiter No. 1 are recovered at the launch MOB and prepared for the next mission. Mission No. 2 is a turnaround timeline where the Booster No. 1 is recovered at the launch MOB and mated with a different orbiter, No. 2, ready for launch. As can be seen, this approach saves approximately two hours in preparing for the next mission.

# Turnaround Analysis

CONCEPT B-1

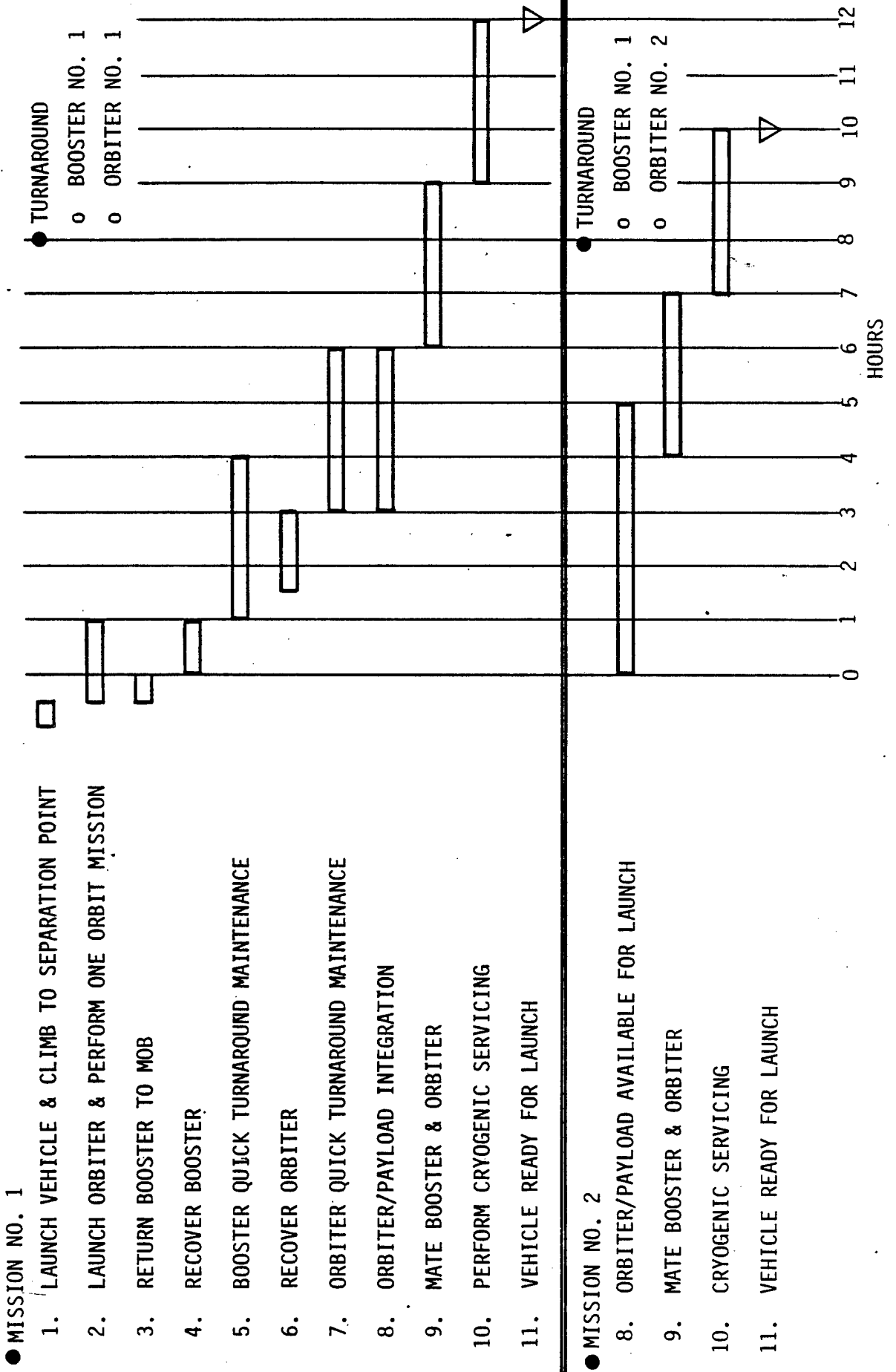

THIS PAGE INTENTIONALLY LEFT BLANK

### **3.1.2 Concept Analysis and Trade Studies**



CONFIGURATION HISTORY

Shown on the opposite page is a series of booster/orbiter configurations which were studied during the Battelle TAV contract before arriving at the recommended two stage Concept B-1.

As seen on the chart the booster configurations studied varied the propulsion choice, wet-wing versus dry wing, and overall planform shape. The orbiter configurations studied also varied the number of rocket engines and the structural concept (hot structure versus thermally protected structure).

The recommended booster configuration (Concept B-1) incorporates both airbreathing and rocket propulsion, separate LO<sub>2</sub>/LH<sub>2</sub> propellant tankage, and JP-4 fuel in the outboard wings.

The recommended orbiter has two alternate designs which basically differ due to the choice of structural materials and thermal protection concept. The "hot structure" concept carries the LO<sub>2</sub> propellant in the wings and has lower reentry planform loading. The "thermal protected structure" concept carries the LO<sub>2</sub> propellant in circular body tanks and has a smaller dry wing with a higher reentry planform loading.

BOEING PROPRIETARY

# Configuration History

D180-27669-4

111

● BOOSTER

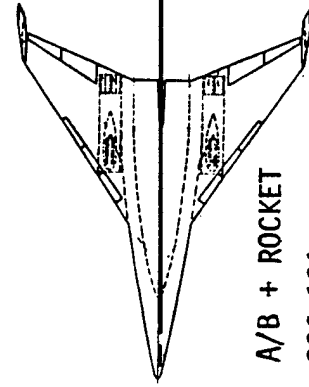

A/B + ROCKET  
896-104

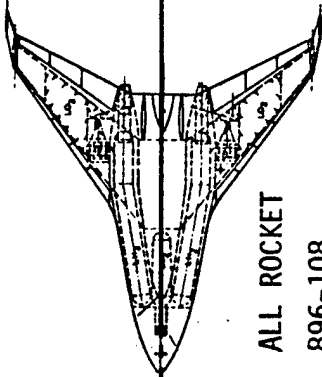

ALL ROCKET  
896-108

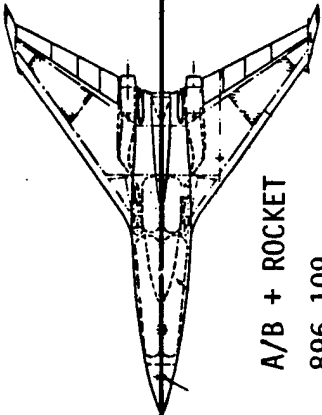

A/B + ROCKET  
896-109

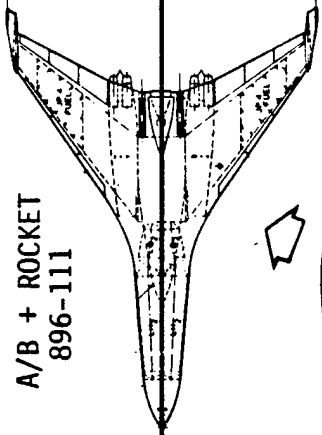

A/B + ROCKET  
896-111

CONCEPT B-1

● ORBITER

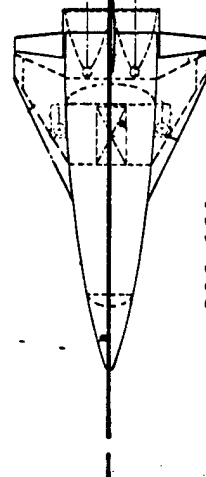

896-104  
(2) SSME ROCKET ENGINES

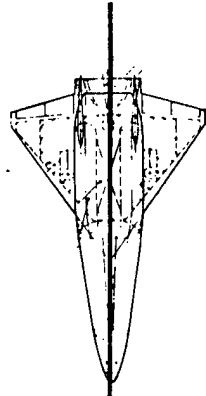

896-107-2  
(1) SSME ROCKET ENGINE

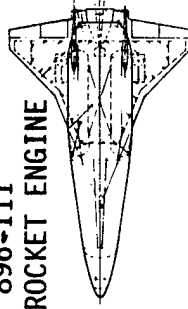

896-111  
(1) SSME ROCKET ENGINE

HOT  
STRUCTURE

ALTERNATE CONCEPTS

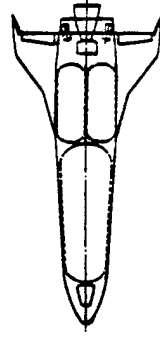

896-112  
(1) SSME ROCKET ENGINE

THERMAL  
PROTECTED  
STRUCTURE

BOEING PROPRIETARY

ORBITER SIZE COMPARISON

This chart illustrates the physical size of the two recommended orbiter concepts when compared to the present day Shuttle vehicle. The inert weights, payload capabilities, and boost propellants are listed. The Space Shuttle has a huge payload bay (15 ft dia x 60 ft long), however, all the boost propellants are carried in a separate expendable drop tank. The two orbiters are designed to carry their own boost propellants. However, their payload bays were down sized to approximately 20 percent of the Shuttle vehicle. Other important differences between the Shuttle vehicle and the orbiters are the number of SSME rocket engines and orbit duration capability.

# Orbiter Size Comparison

o SPACE SHUTTLE

$W_1 = 165,000$  LB

$P/L = 65,000$  LB

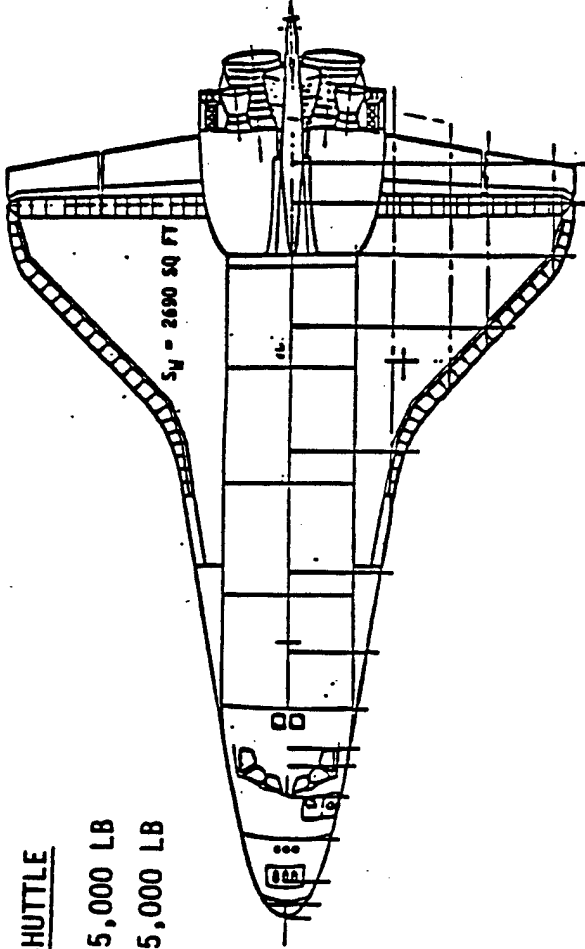

MODEL 896-111

o ORBITER

$W_1 = 86,236$  LB

$W_p = 471,200$  LB

$P/L = 20,000$  LB

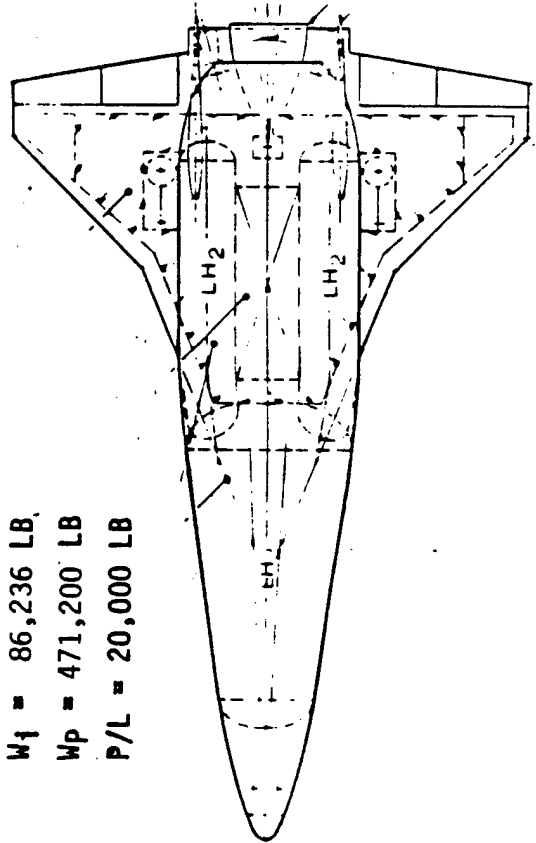

MODEL 896-112

o ORBITER

$W_1 = 84,950$  LB

$W_p = 450,000$  LB

$P/L = 16,050$  LB

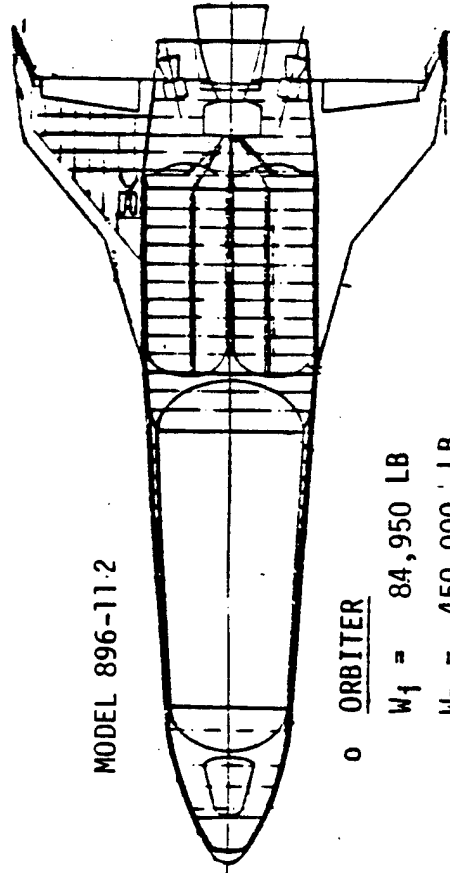

## BOEING PROPRIETARY

## REUSABLE ORBITER CONCEPT B-1 THERMAL PROTECTED STRUCTURE

Shown in the 3-view chart is an orbiter concept which is thermally protected with high temperature reusable surface insulation tiles covering the lower surface and low temperature reusable surface insulation blankets covering the upper surface. Advanced carbon-carbon is used for the nose cone and leading edges. Standoff composite panels hold the thermal protection system away from the H<sub>2</sub> tank conical section and distribute local air loads through structural supports attached to the titanium sandwich H<sub>2</sub> tanks. Two L02 tanks are located below the 10 ft diameter x 24 ft payload bay. This provides for good c.g. control by placing the heavy L02 tanks as well as the variable weight (payload in/payload out) as close as possible to the center of pressure range of the vehicle.

This vehicle uses one SSME-150 with 2 RL-10s for boost thrust. Absolute minimum subsystems have been included for the once-around mission. Through application of 1990 technology to Shuttle subsystems and conversion to the maximum use of composite structure, the projected dry weight approaches 78,000 lbs. With such a light vehicle the wing size may come down significantly with respect to the Shuttle. This will reduce weight further while complicating the balance problem associated with reentry and landing. The wing is sized for landing wing loading of 64 lb/lb<sup>2</sup> and because of the smaller wing influence on hypersonic CP the wing must be placed further aft. Tip fins are utilized for lateral control.

BOEING PROPRIETARY

# Reusable Orbiter Concept B-1 Thermal Protected Structure

Model 896-112

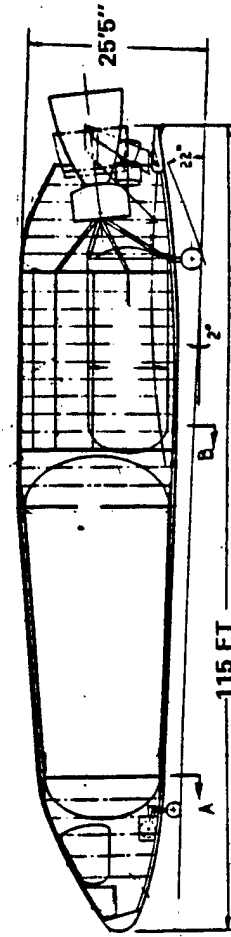
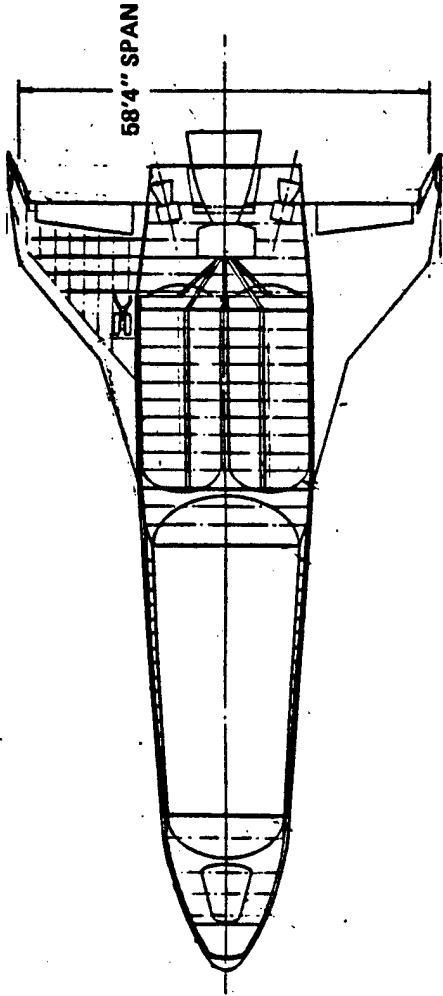

### CHARACTERISTICS

T/W @ SEPARATION	.995
SW	1500 FT <sup>2</sup>
W/S LANDING	63.8
W/S REENTRY	31.1
W PROPELLANT USABLE	450,000 LB
W INERT	84,950
W P/L	16,050
W GROSS	551000

D180-27669-4  
115

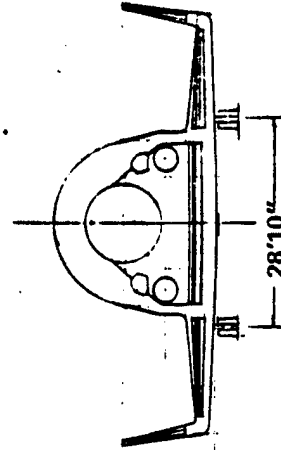

**BOEING PROPRIETARY****STRUCTURAL ARRANGEMENT/INBOARD PROFILE**

The structural arrangement as shown uses composite build-up for most of the primary orbiter structure. Fuselage structure is conventional frame, stringer and skin panel construction with the exception of the evacuated titanium sandwich LH<sub>2</sub> tank. Fore and aft LH<sub>2</sub> tank Y-rings carry orbiter loads into and out of the LH<sub>2</sub> tank. Structure attached to the LH<sub>2</sub> tank supports consists of standoff composite panels and TPS. This structure also supports the leading edge fairing on the underbody. The structure is thermally protected by an external thermal protection system composed of Fiber Reinforced Composite Insulation (FRCI) tiles and Advanced Flexible Reusable Surface Insulation (AFRSI) blankets. Thrust loads are distributed into the LO<sub>2</sub> tanks, payload bay longerons, and aft fuselage by the thrust structure. Advanced carbon-carbon is used for the nose cone and leading edges.

# BOEING PROPRIETARY Structural Arrangement / Inboard Profile

Model 896-112

D180-27669-4

117

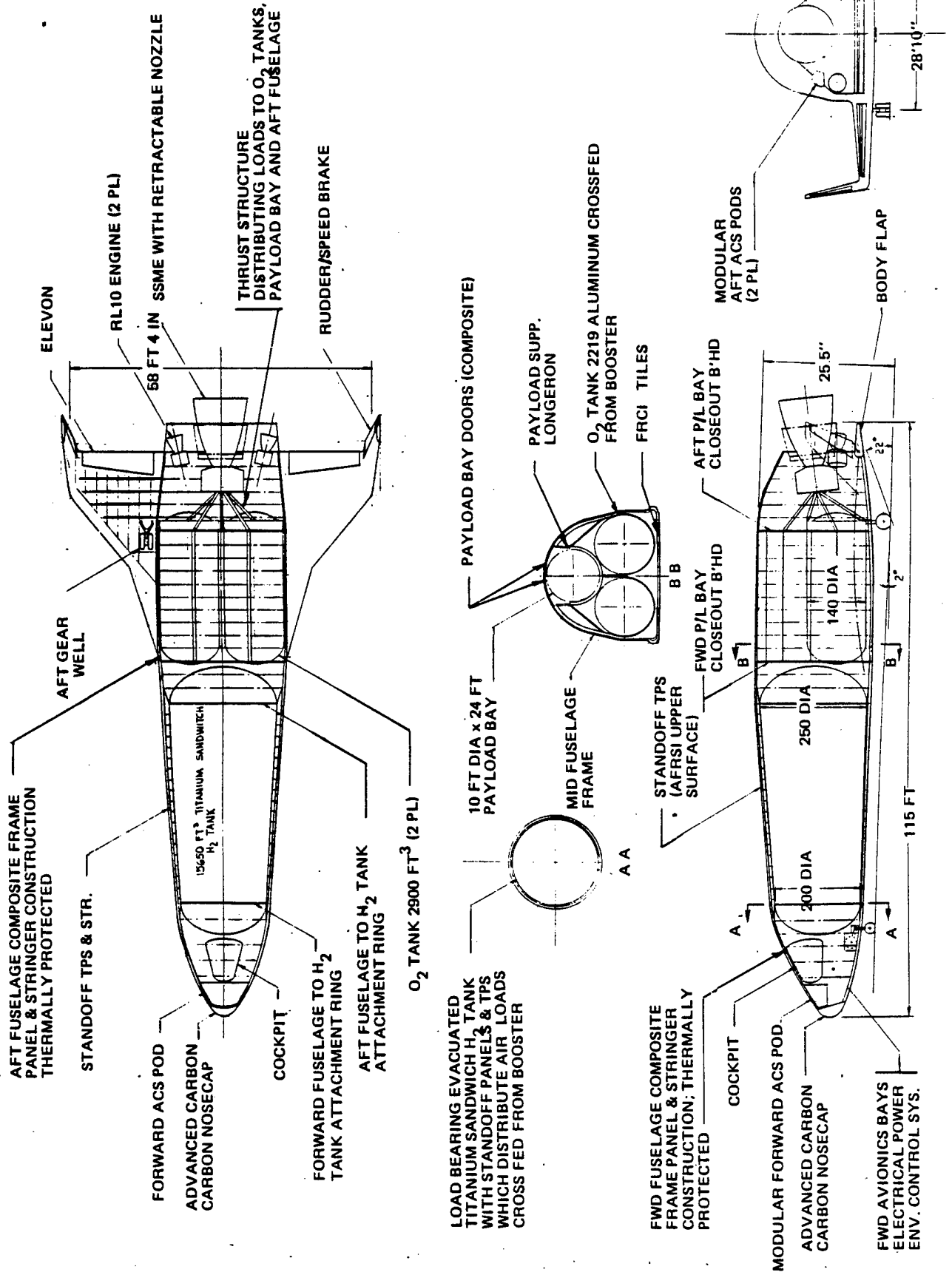



D180-27669-4  
118

**BOEING PROPRIETARY**  
**ORBITER KEY CHARACTERISTICS**  
(MODEL 896-112)

The orbiter concept shown incorporates 1990 technology to the total orbiter concept in order to realize the projected weights. The cockpit is designed to 2-man maximum crew with minimum life support provisions for short duration missions (once-around). There is no airlock in the cockpit and ingress/egress is done through a single overhead hatch. Electrical power is provided by batteries.

Ascent propulsion is provided by a 112 percent SSME with a 150:1 area ratio and two RL-10s. It is possible to better match thrust to separation weight with a combination of advanced engines designed more for this application. Attitude control is accomplished with modular fore and aft bipropellant ACS pods much like those used in the Shuttle. It is recognized that these will potentially complicate the already strained turnaround time requirements. An attractive solution would possibly be to convert the ACS to L02/LH2 pending studies of such a system.

Electro-mechanical actuators are used for surface controls, payload bay door actuation, RL-10 TVC, payload attention and deployment, and nozzle retraction. SSME thrust vector control is provided by a power takeoff from the SSME, driving a hydraulic pump which in turn supplies hydraulic power to TVC actuators. Brake actuation is provided by hydraulic pressure accumulations. The gear is free fall deployed with electrical/mechanical backup.

Thermal control is accomplished by ground support equipment prior to launch. From launch to 140,000 ft there is capability for the cold plates and coolant loops to absorb the rejected heat without exceeding subsystem maximum temperature limits. At 140,000 ft the boiling temperature of water is compatible with the coolant system and the water spray boilers come on line. With short missions the water supply does not become prohibitive for flight above 140,000 ft. An ammonia boiler provides cooling system requirements on reentry below 140,000 ft.

Environmental control consists of a coolant loop around the cockpit, redundant air supply O<sub>2</sub> and N<sub>2</sub> bottles and fan air/water separators to control humidity within the cockpit.

Advanced technology has been applied to avionics and instrumentation with respect to the Shuttle. The computer processor units, input/output processors and mass memory units are scaled down appropriately. Remote switching has been incorporated to reduce wiring to and from the crew cab.

Communications include a KU band TDRSS link and downlink systems. Televisions are included in the payload bay, in the cockpit, and in the forward landing gear bay for landing.

Navigation aids include IMUs which are initialized with respect to the launch pad prior to launch and support guidance through reentry until acquisition of tactical air navigation system station signals directing the vehicle to the correct heading alignment cylinder. The microwave scan beam landing system takes over at roughly 18,000 ft and a range from landing strip of 12-13 nmi for a more accurate approach. A radar altimeter is used for approach and landing below 9000 ft. An air data subsystem is operational below mach = 3. There are provisions for both manual and automatic flight control. The second stage guidance is closed loop to main engine cutoff target.

BOEING PROPRIETARY

# Orbiter Key Characteristics

Model 896-112

- NAVIGATION AIDS: IMUs**  
 TACTICAL AIR NAVIGATION (140,000 FT-18,000 FT (12-13 NM RANGE FROM LANDING))  
 MICROWAVE SCAN BEAM LANDING SYSTEM (FROM 18000 FT, 12-13 NM RANGE)  
 AIR DATA SYSTEM (BELOW M 3)  
 RADAR ALTIMETER (BELOW 9000 FT.)
- GUIDANCE NAV. & CONTROL:**  
 MANUAL AND AUTO FLIGHT CONTROL  
 IMUs & NAV. INITIALIZES AT LAUNCH WRT LAUNCH PAD POSITION  
 RATE GYROS ON ORBITER & ACCELEROMETER ASSEMBLIES  
 2ND STAGE GUIDANCE CLOSED LOOP TO MECO TARGET
- THERMAL CONTROL ACCOMPLISHED BY GSE UNTIL LAUNCH, THERMAL SOAK FROM LAUNCH TO 140,000 FT, WATER SPRAY BOILERS--FREON LOOP FOR FLIGHT ABOVE 140,000 FT. AMMONIA BOILER--FREON LOOP FOR REENTRY BELOW 140,000 FT.**
- ENVIRONMENTAL CONTROL: REDUNDANT O<sub>2</sub> & N<sub>2</sub> SUPPLY BOTTLES**  
 FAN AIR/H<sub>2</sub>O SEPARATORS
- AVIONICS: COMPUTER PROCESSOR UNITS INPUT/OUTPUT PROCESSORS**  
 MEMORY MODULES, REMOTE SWITCHING TO REDUCE WIRING TO/FROM COCKPIT
- COMMUNICATIONS: Ku BAND DOWNLINK AND TDRSS LINK**
- TELEVISION: PAYLOAD BAY & FORWARD GEAR WELL FOR LANDING; COCKPIT**

D180-27669-4

119

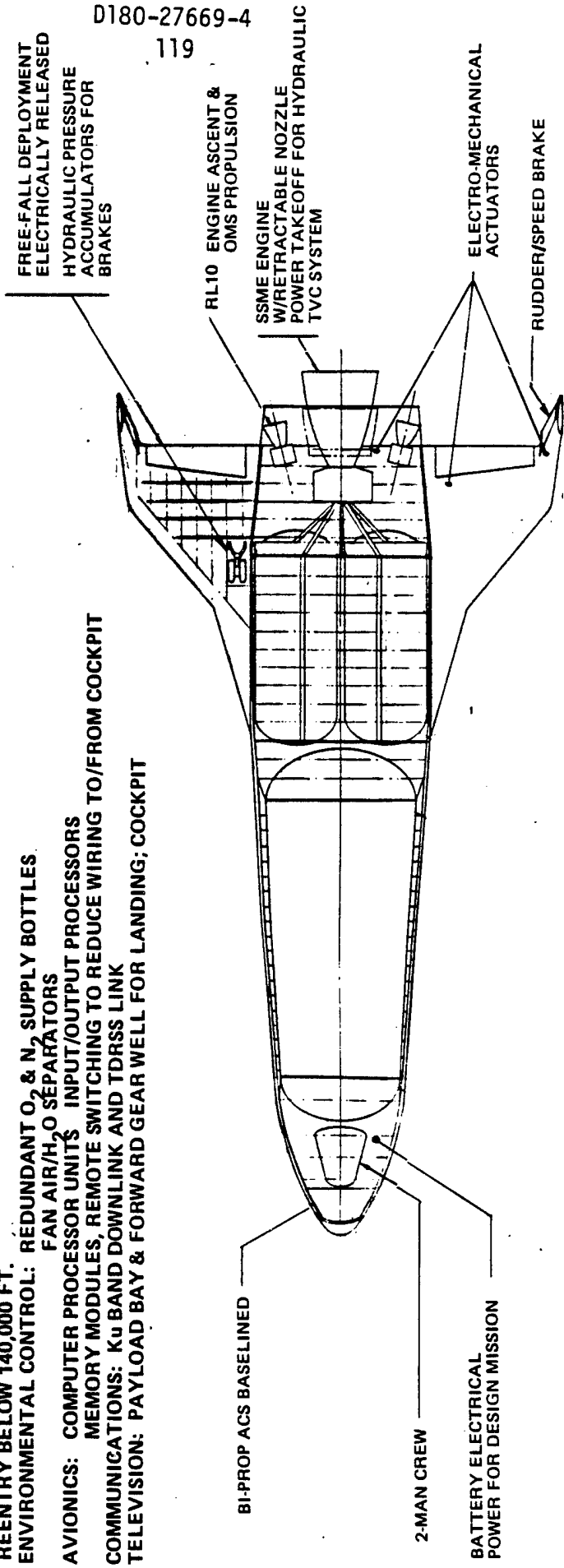

## BOEING PROPRIETARY

### ORBITER GROUP WEIGHT STATEMENT MODEL 896-112

The 896-112 orbiter was designed to be fully compatible with the 896-111 booster. The orbiter employs a dry-wing concept in combination with improved Space Shuttle Reusable Surface Insulation (RSI). Wing planform is traded for increased body volume to accommodate LO<sub>2</sub> body tanks. Since the orbiter has to fit into the booster cavity, it is volume limited, resulting in a lower propellant and gross weight. A brief discussion of the group weight statement by section follows.

#### AERO SURFACES

(5730 lb)

These surfaces are of composite design. Wing mass includes the box body-carry through section and main gear installation provisions. Composite unit weights were estimated at 70 percent of the unit weight of aluminum designed structure.

#### BODY

(26,960 lb)

The body consists of the same basic sections as the B-1 orbiter plus two all welded 2219-T87 aluminum LO<sub>2</sub> propellant tanks. The LH<sub>2</sub> tank is an all welded 6AL-4V(EL1) titanium ring stiffened pressure vessel. The rest of the body is basically of composite design with unit masses of 70 percent of the unit mass of aluminum designed structure.

#### INDUCED ENVIRONMENTAL CONTROL

(14,060 lb)

This group consists of the external TPS system plus internal provisions for thermal control and purge/vent/drain. The external TPS system utilizes advanced RSI on all areas. The density of the RSI is 7.5 lb/ft<sup>3</sup> except in the wing leading edge and body skin areas where the density is 20.0 lb/ft<sup>3</sup>.

#### PROPULSION

This propulsion system employed a retractable nozzle advanced SSME type engine in combination with two RL-10's. Accessories and propellant feed system weights are similar to those utilized on the B-1 orbiter. RCS inerts and propellant weights are greater than those used in the B-1 orbiter due to an increased duty cycle (vertical fin area reduced).

#### LANDING AND AUXILIARY SYSTEMS

(3300 lb)

In addition to landing gear this group includes a landing drag device (0.33 percent of design landing weight).

#### WEIGHT MARGIN

(8629 lb)

The growth margin used in this weight statement was 15 percent or five percent greater than that used in the B-1 orbiter. Reducing this margin to 10 percent would increase the payload by 2870 lbs (16,050 to 18,920 lb).

BOEING PROPRIETARY  
**Orbiter Group Weight Statement**  
 Model 896-112

WEIGHT STATEMENT

AREA (FT<sup>2</sup>)

BODY PLANFORM-INCL FLAP 2,370  
 BODY FLAP 120  
 EXPOSED WING PLANFORM-INCL ELEVONS 610  
 ELEVONS 90  
 TIP FINS PLANFORM 70  
 VEHICLE PLANFORM 3,074  
 TIP FINS INCL RUDDER PER TIP 70  
 RUDDER 20  
 BODY WETTED AREA EXCL FLAP 7,110  
 BODY BASE AREA ABOVE FLAP 300

PLANFORM LOADING (PSF)

ENTRY-NO P/L 25.9  
 ENTRY-WITH P/L 31.1  
 LANDING WITH P/L 63.8

WEIGHT (LB)

AEROSURFACES INCL FLAP 5,730  
 BODY INCL MAIN TANK 26,960  
 INDUCED ENVIRONMENTAL PROTECTION 14,060  
 PROPULSION-ASCENT/OMS 11,740  
 PROPULSION-RCS 1,300  
 SYSTEMS (PRIME POWER, ELECTRICAL, SURFACE CONTROLS, AVIONICS, ECS, PERSONNEL PROVISIONS, PAYLOAD PROVISIONS THERMAL CONTROL, PURGE/VENT/ DRAIN SYSTEM 6,100  
 LANDING & AUXILIARY SYSTEMS 3,300  
 WEIGHT MARGIN 15% EXCL ENGINES 8,620  
(DRY WEIGHT) (77,810)  
 PERSONNEL (2) 480  
 PAYLOAD (ROUNDTrip) 16,050  
 RESIDUALS & RESERVES @ LANDING 1,410  
 INFLIGHT LOSSES 4,250  
 -----  
 OMS PROPELLANT-NOMINAL 1,000  
 RCS PROPELLANT-NOMINAL 450,000  
 ASCENT PROPELLANT INCL FDC 551,000  
 GROSS WEIGHT @ SEPARATION

### LAUNCH VEHICLE CONCEPTS

This chart summarizes the advantages and disadvantages of three different launch vehicle concepts investigated during the Battelle TAV study contract. The booster concepts include:

- o All-rocket boost propulsion with go-around/landing airbreathing engines
- o An airbreathing plus rocket engine combination
- o All airbreathing engine concept

The orbiters were all powered by LO<sub>2</sub>/LH<sub>2</sub> SSME rocket engines.

# Launch Vehicle Concepts

STAGING VELOCITY = 2500 FT/SEC

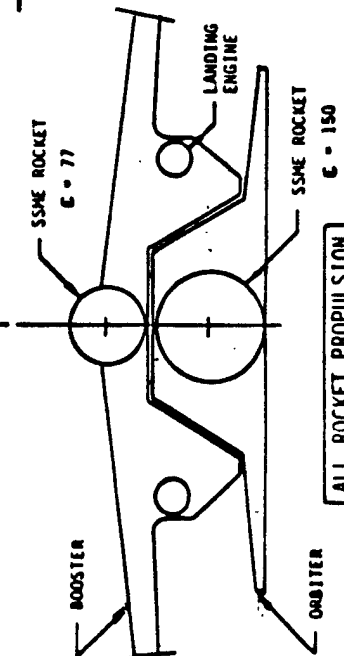
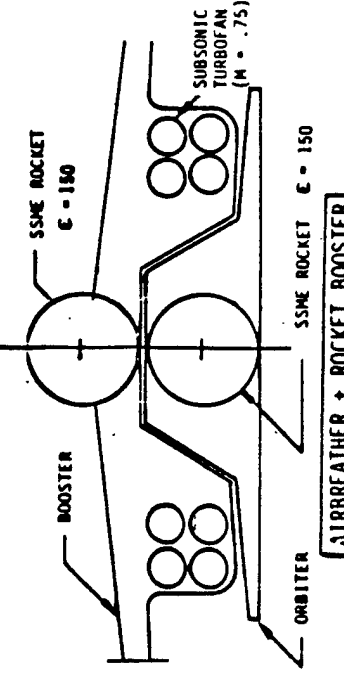
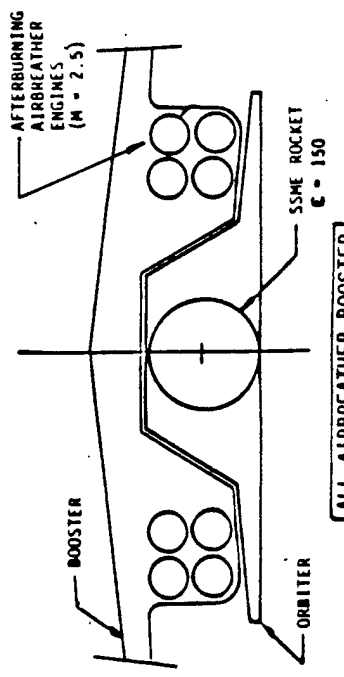
	ADVANTAGES	DISADVANTAGES
 <p>ALL ROCKET PROPULSION</p>	<ul style="list-style-type: none"> <li>● REDUCED PROPULSION ENGINE WEIGHT</li> <li>● SIMPLIFIED PROPULSION CONTROL</li> </ul>	<ul style="list-style-type: none"> <li>● PARASITIC BOOSTER LANDING AND GO-AROUND ENGINES</li> <li>● HIGHER GLOW (LOWER I<sub>sp</sub> AVE)</li> <li>● DEVELOPMENT COST UPGRATED SSME ENGINE</li> </ul>
 <p>AIRBREATHER + ROCKET BOOSTER</p>	<ul style="list-style-type: none"> <li>● AIRBREATHING SFC</li> <li>● ALTERNATE MISSION CAPABILITY</li> <li>● GOOD FERRY CAPABILITY</li> <li>● AIRBREATHER T/O NOISE LEVELS</li> </ul>	<ul style="list-style-type: none"> <li>● DEVELOPMENT COSTS OF UPGRATED AUGMENTED TURBOFANS (F-101)</li> <li>● DEVELOPMENT COSTS, OF UPGRATED ROCKET ENGINES                             <ul style="list-style-type: none"> <li>○ SSME <math>\approx</math> 112%</li> <li>○ RL-10 <math>\approx</math> 200%</li> </ul> </li> </ul>
 <p>ALL AIRBREATHER BOOSTER</p>	<ul style="list-style-type: none"> <li>● AIRBREATHING SFC</li> <li>● GOOD FERRY CAPABILITY</li> <li>● AIRBREATHER T/O NOISE LEVELS</li> </ul>	<ul style="list-style-type: none"> <li>● DEVELOPMENT TIME AND COST FOR NEW HIGH THRUST AIRBREATHING ENGINES                             <ul style="list-style-type: none"> <li>○ TURBOJET AUGMENTED</li> <li>○ TURBORAMJET</li> </ul> </li> </ul>

#### NON-OPTIMUM SEPARATION VELOCITY PENALTY

Selection of the first-stage burnout velocity may have a significant impact on the vehicle payload. The effect of varying burnout velocity is shown for two different missions with north and east launches. In both cases the Boeing concept provides a payload which is slightly below maximum. This concept was designed to achieve a payload capability as near optimum as possible. Maximizing the payload fraction would require increasing the separation velocity to approximately 4000 fps. This separation velocity comparison assumes a constant set of  $\lambda$  values regardless of burnout velocity. As  $V_{bo}$  is increased, the booster propellant weight increases and the orbiter propellant weight decreases, altering the achievable values of  $\lambda$ . If this effect were included, the curves would be more flat in the region of interest and the attendant payload penalty for non-optimum separation velocity would be considerably reduced.

BOEING PROPRIETARY  
**Non-Optimum Separation Velocity Penalty**

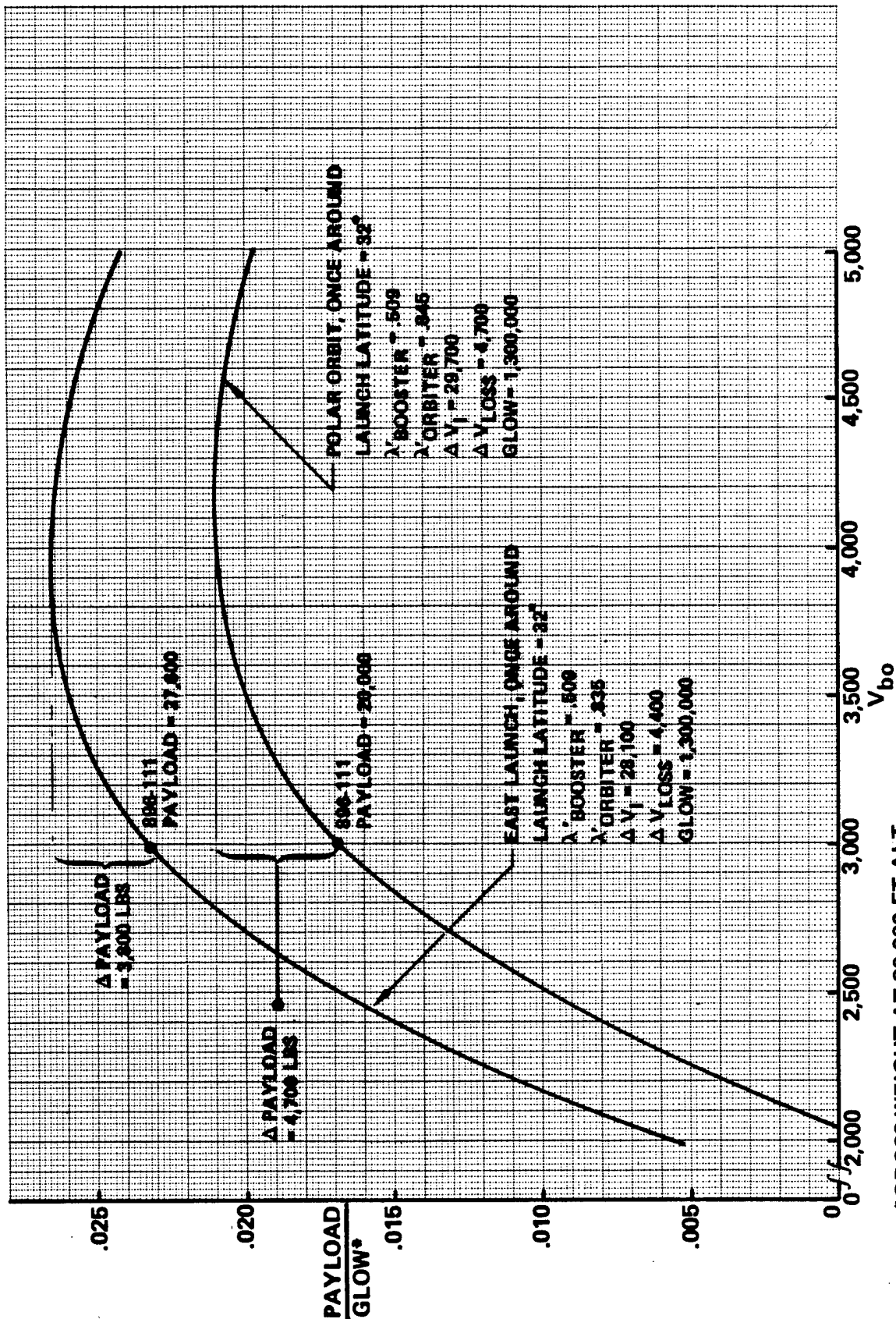

\*GROSS WEIGHT AT 30,000 FT ALT



## BOOSTER/ORBITER SEPARATION ANALYSIS

Preliminary analysis of the booster/orbiter separation is presented. At separation the booster SSME is step throttled to a 35 percent thrust level while the orbiter maintains maximum thrust. The cross-feed fuel system is then disconnected and the trapeze is released. Because of the differential thrust levels and gravitational forces, the orbiter begins to separate from the booster. The trapeze mechanism insures guided and safe controlled separation during this phase. At the point where the separation velocity is maximum, the orbiter is released from the trapeze and continues its ascent. The booster then initiates its post-separation maneuver and returns to the launch site. Because of the complex aerodynamics of the separation, the approach used was that of bracketing the solution. The first analysis was conducted assuming zero dynamic pressure. In this case the complete separation requires 6.2 seconds. When the free-stream dynamic pressure of 65 lbs/ft<sup>2</sup> is taken into account, the aerodynamic lift of the booster forces the vehicles to separate in the much quicker time of 1.5 seconds. Since aerodynamic forces can be controlled through the angle of attack, booster/orbiter separation is a controlled maneuver that can be manipulated to optimize performance and guarantee flight crew safety.

BOEING PROPRIETARY

# Booster/Orbiter Separation Analysis

CONCEPT B-1

● CONDITION AT SEPARATION

M = 3.0  
ALTITUDE 120,000 FT  
q = 65 PSF

● BOOSTER

W = 298,000 LB APPROX  
SSME ROCKET = 190 K LB THRUST  
( THROTTLED TO 35% )

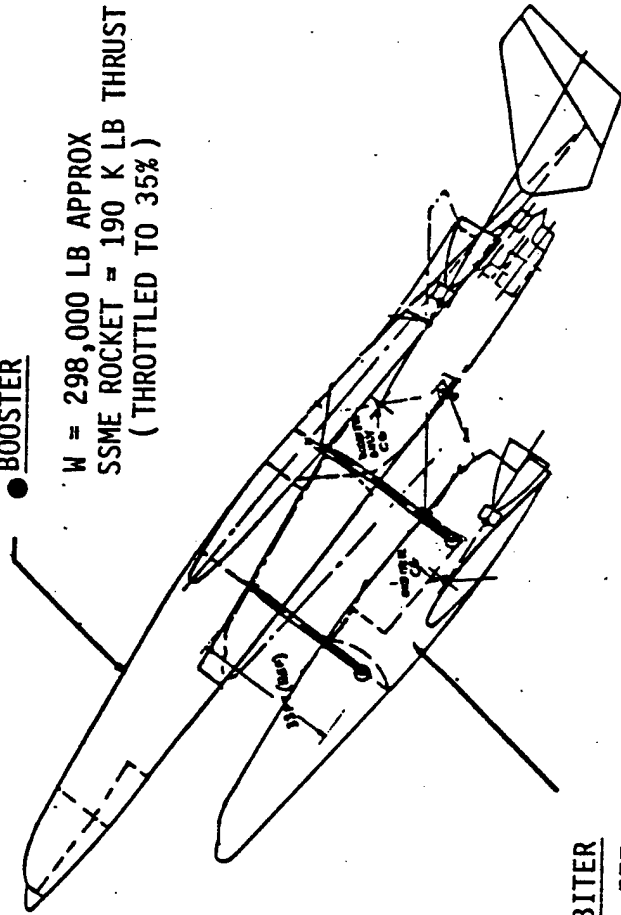

● ORBITER

W = 577,500 LBS  
SSME ROCKET = 530 K LB THRUST  
PLUS (4) RL10 ADV @138,000 LBS TOTAL THRUST

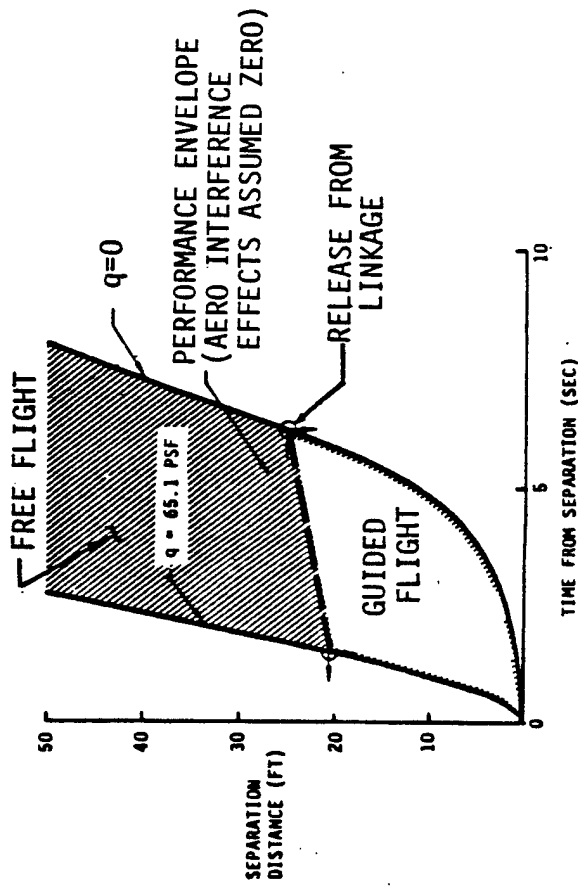

BOEING PROPRIETARY

#### RIGID AERODYNAMIC CENTER VARIATION VS MACH

The rigid aerodynamic center varies from approximately 18 percent MAC at low speed to approximately 38 percent slightly above sonic speed. The center of gravity ranges from 22 percent MAC to 18 percent MAC as weight decreases during the mission. Since the vehicle is statically unstable during a large portion of the subsonic mission leg, a full time longitudinal stability augmentation system (SAS) is required. The minimum time to double perturbation oscillation amplitude is approximately 1.7 seconds, well within the capability of a state-of-the-art SAS. An attempt will be made during future design iterations to eliminate the need for a flight critical SAS through rebalancing of the vehicle.

BOEING PROPRIETARY

# Rigid Aerodynamic Center Variation vs Mach

MODEL 896-111, CONCEPT B-1

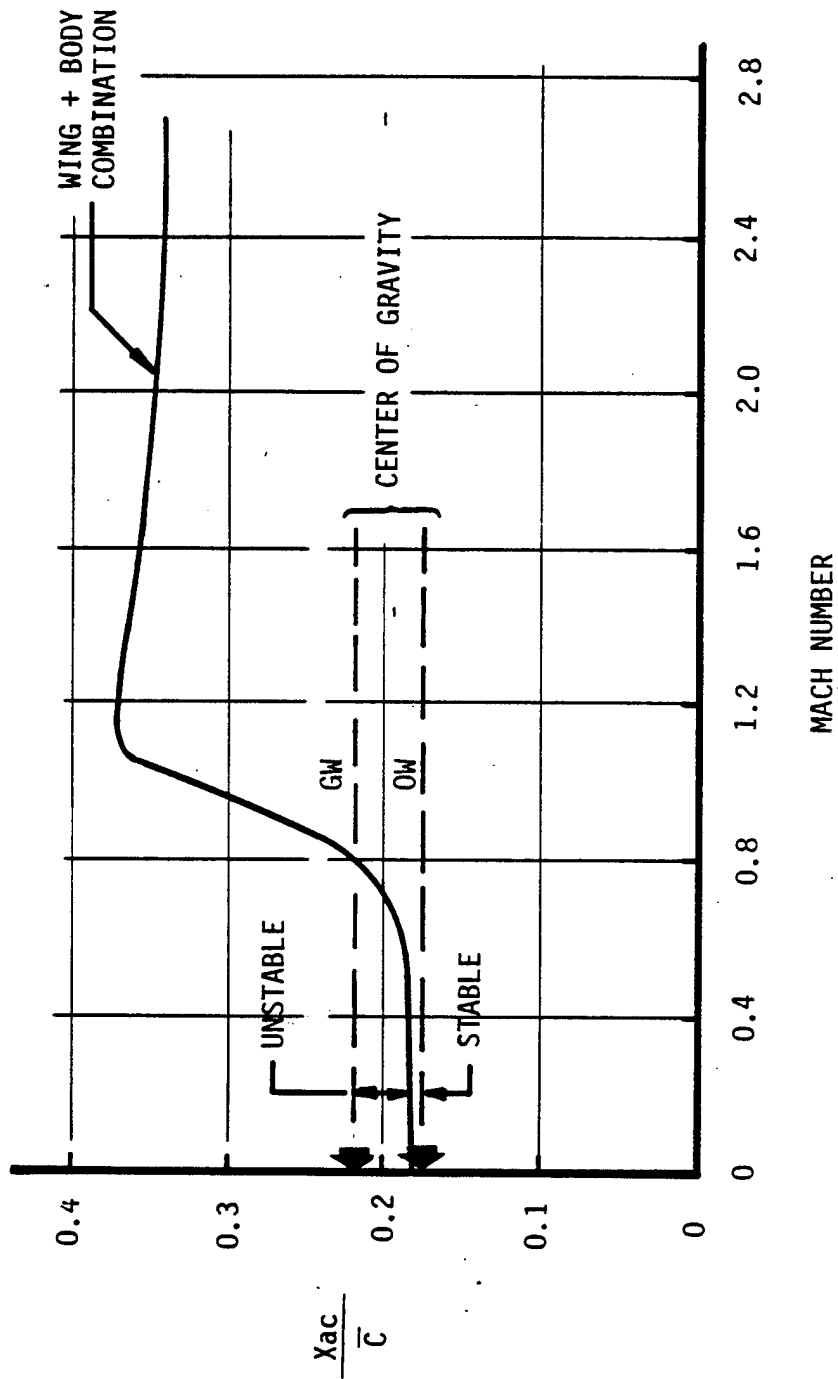

## POST INPUT DATA

Shown is a directory to the necessary data for performance verification of Model 896-111 (Concept B-1) using POST (Program to Optimize Simulated Trajectories). A complete POST input file and corresponding output are included in Appendix B.

# Post Input Data

CONCEPT B-1

<u>ITEM</u>	<u>CHART</u>	<u>PAGE</u>
● CONFIGURATION ENGINE LOCATION COORDINATE SKETCH	TWO-STAGE HTO LAUNCH SYSTEM CONCEPT B-1 REUSABLE ORBITER CONCEPT B-1 - HOT STRUCTURE	73 75
● PROPULSION SYSTEM	PROPULSION SYSTEM SUMMARY	143, 145, 147, 149 & 151
● AERODYNAMIC DATA REFERENCE AREA	TAV BOOSTER/ORBITER AERODYNAMICS TAV ORBITER AERODYNAMICS (ASCENT CONFIGURATION) TAV ORBITER AERODYNAMICS (ENTRY CONFIGURATION)	135 139 141
● CENTER OF GRAVITY	RIGID AERODYNAMIC CENTER VARIATION VS MACH	129
● TRAJECTORY ALTITUDE, ATTITUDE VELOCITY, THRUST	TAV BOOST TRAJECTORY /TRAJECTORY LOSSES	153, 155 & APPENDIX B [3]
● WEIGHTS REFERENCE LENGTHS	BOOSTER GROUP WEIGHT STATEMENT ORBITER GROUP WEIGHT STATEMENT	93 83 & 121
● FUEL BREAKDOWN	BOOSTER JP TO 30 K FT M = .862 = 115,000 LBS ROCKET PROPELLANT = 299,300 LBS JP FROM 30 K FT M = .862 = 10,000 LBS	
● COMPLETE POST INPUT DATA FILE	ORBITER ROCKET PROPELLANT = 471,200 LBS	

D180-27669-4

APPENDIX B

#### APAS COMPUTER MODEL OF BOOSTER/ORBITER

APAS (Aerodynamic Preliminary Analysis System) was used to generate the aerodynamic characteristics of the combined vehicles. After modeling the configuration, APAS utilizes skin friction, far field wave drag, and vortex lattice techniques in estimating the aerodynamic characteristics of the configuration.

BOEING PROPRIETARY

# APAS Computer Model of Booster/Orbiter

MODEL 896-111, CONCEPT B-1

VNUJ PITCH ROLL  
0.0 10.0 0.0

D180-27669-4  
133

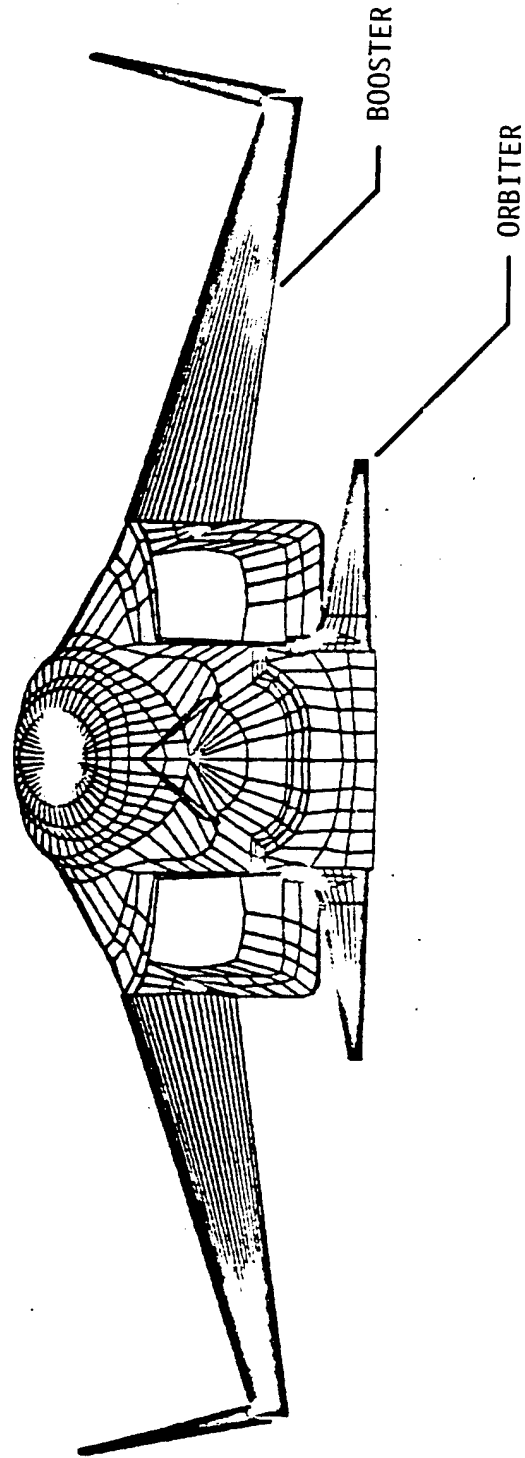



TAV BOOSTER/ORBITER - AERODYNAMICS

Aerodynamic estimates of the combined booster/orbiter configuration were generated through APAS (Aerodynamic Preliminary Analysis System) and several other preliminary design techniques. Minimum drag,  $C_{D0}$ , is composed of skin friction, interference, base, and wave drag. Base drag is included only in the subsonic flight regime. At Mach = 0.862 the rocket engines are ignited and the base drag becomes negligible. The combined booster/orbiter combination provides for an (L/D) max of 11.8 at Mach = .2 and decreases to 8.6 at Mach = 0.9. The degradation in performance is attributed to the increase in base drag with Mach number.

# BOEING PROPRIETARY TAV Booster/Orbiter-Aerodynamics

CONCEPT B-1

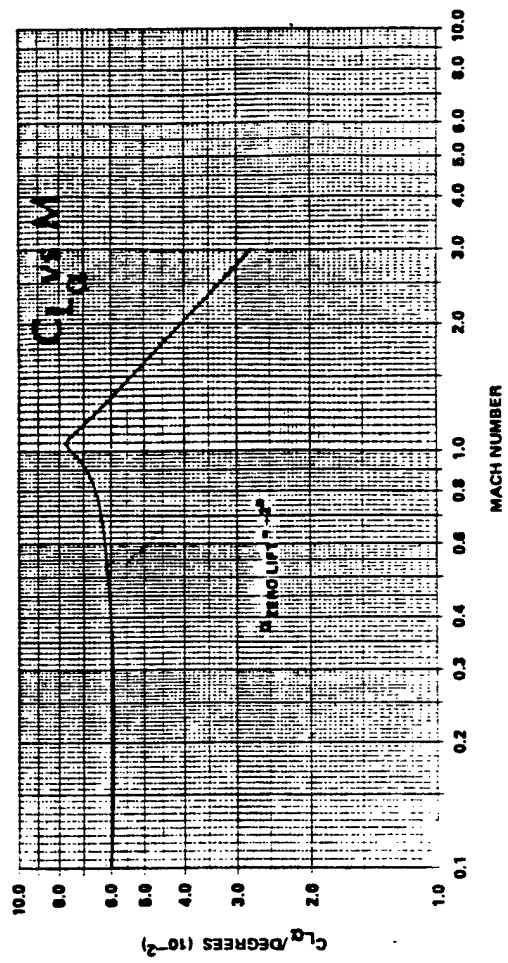
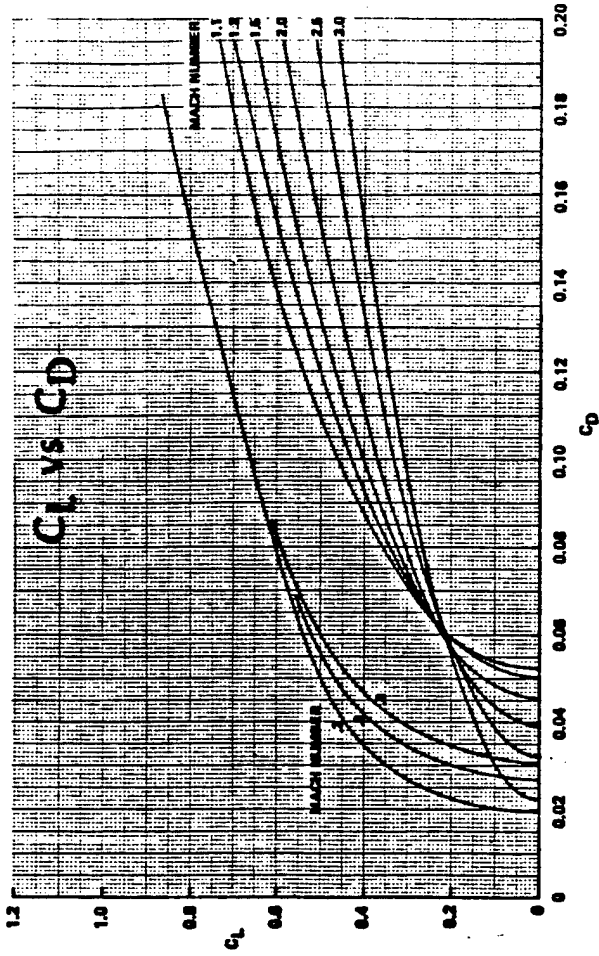
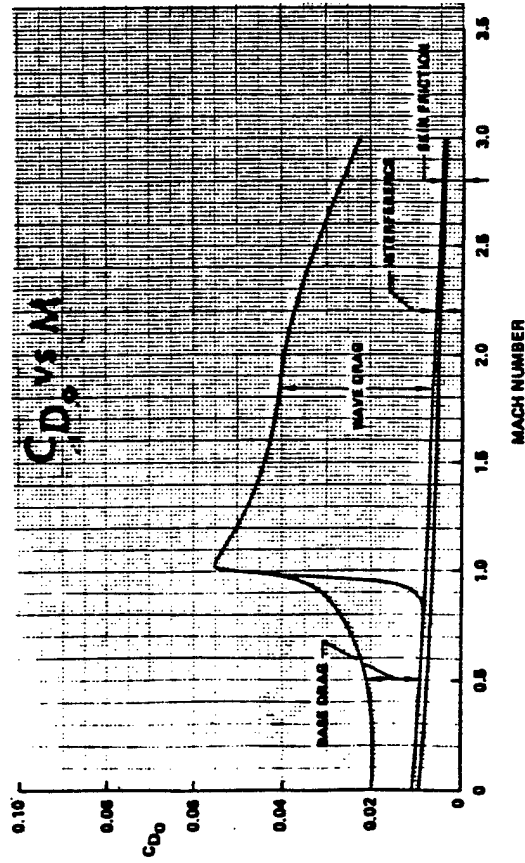

NOTE: BASE DRAG NOT INCLUDED DURING  
ROCKET ENGINE OPERATION

$S_{REF} = 9,000 \text{ FT}^2$

## APAS COMPUTER MODEL OF ORBITER

The aerodynamic characteristics of Model 986-111 orbiter were generated by APAS (Aerodynamic Preliminary Analysis System). In the hypersonic mode, APAS uses the Mark III version of the Hypersonic Arbitrary Body Program originally developed by the McDonnell Douglas Corporation.

**BOEING PROPRIETARY**  
**APAS Computer Model of Orbiter**

MODEL 896-111 CONCEPT B-1

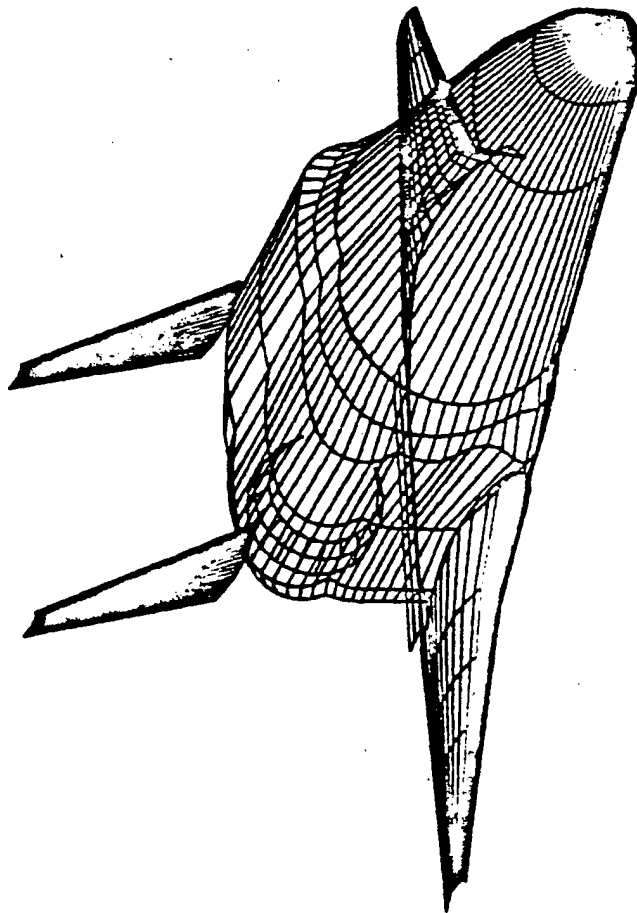

BOEING PROPRIETARY

TAV ORBITER - AERODYNAMICS

Aerodynamic estimates of Model 896-111 Orbiter were generated through the hypersonic arbitrary body option in APAS (Aerodynamic Preliminary Analysis System). In the ascent configuration the base drag is negligible and is not included in the estimates. This provides for an (L/D) max of 2.27 at  $M = 2.5$  and decreases to 2.11 at  $M \geq 10$ .

BOEING PROPRIETARY

# TAV Orbiter - Aerodynamics

CONCEPT B-1

D180-27669-4  
139

## ASCENT CONFIGURATION

$C_L$  vs  $\alpha$

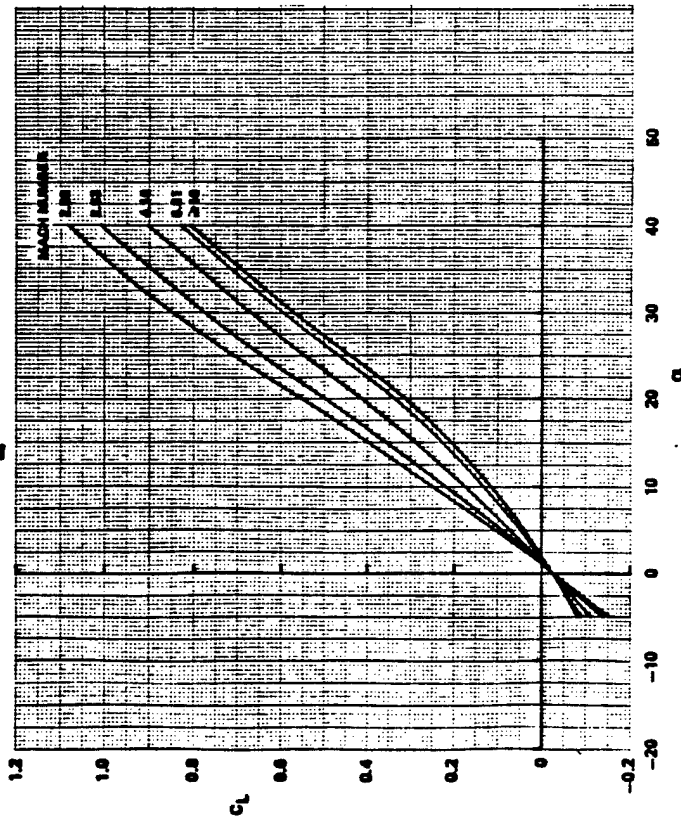

$C_L$  vs  $C_D$

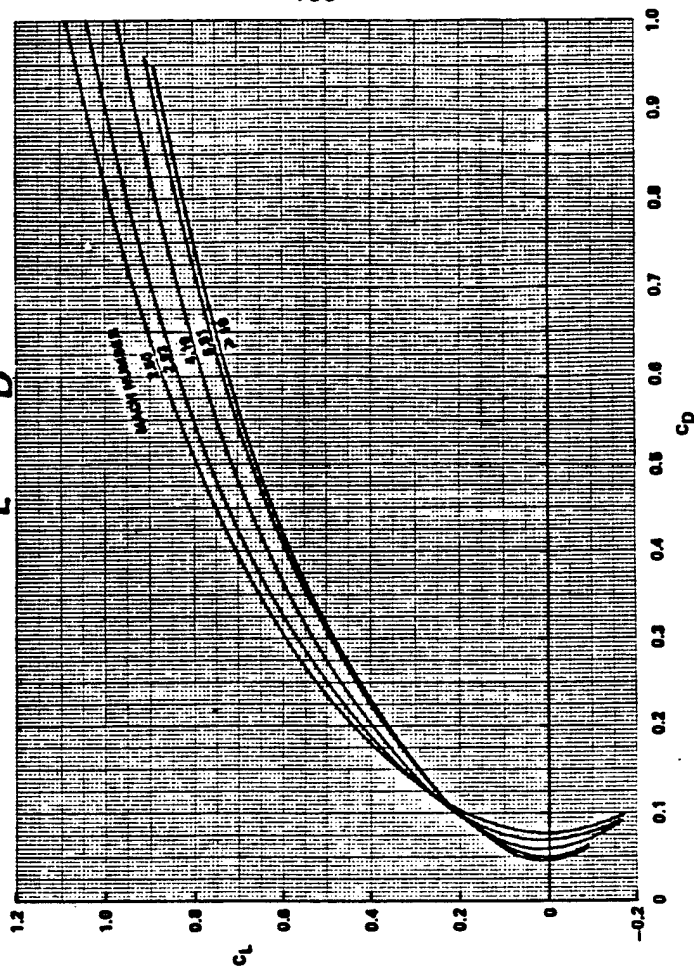

$S_{REF} = 2,510 \text{ FT}^2$

BOEING PROPRIETARY

TAV ORBITER - AERODYNAMICS

Aerodynamic estimates of Model 896-111 orbiter in the entry configuration were generated through APAS (Aerodynamic Preliminary Analysis System). The difference between the ascent and entry configuration is the base drag penalty experienced when the rocket engines are not thrusting. This penalty was estimated in the hypersonic arbitrary body program through an empirical high Mach number base pressure technique. The resultant performance penalty was a reduction in  $(L/D)_{\max}$  from 2.27 to 1.92 and from 2.11 to 1.75 at  $M = 2.5$  and 10 respectively over the ascent configuration.

BOEING PROPRIETARY

# TAV Orbiter - Aerodynamics

CONCEPT B-1

D180-27669-4  
141

## ENTRY CONFIGURATION

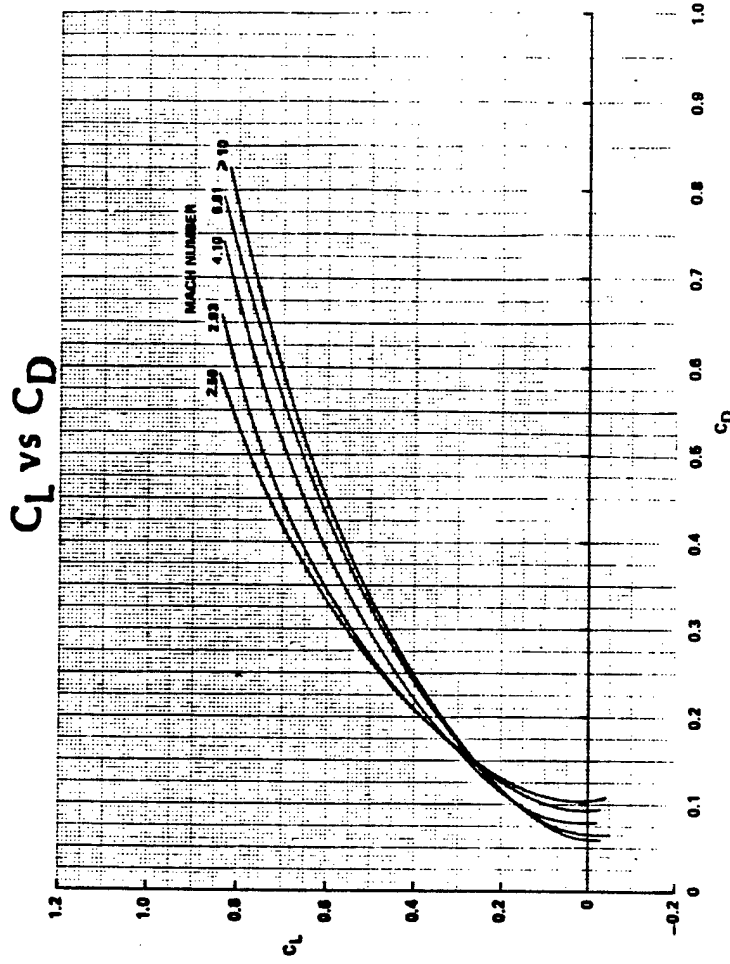
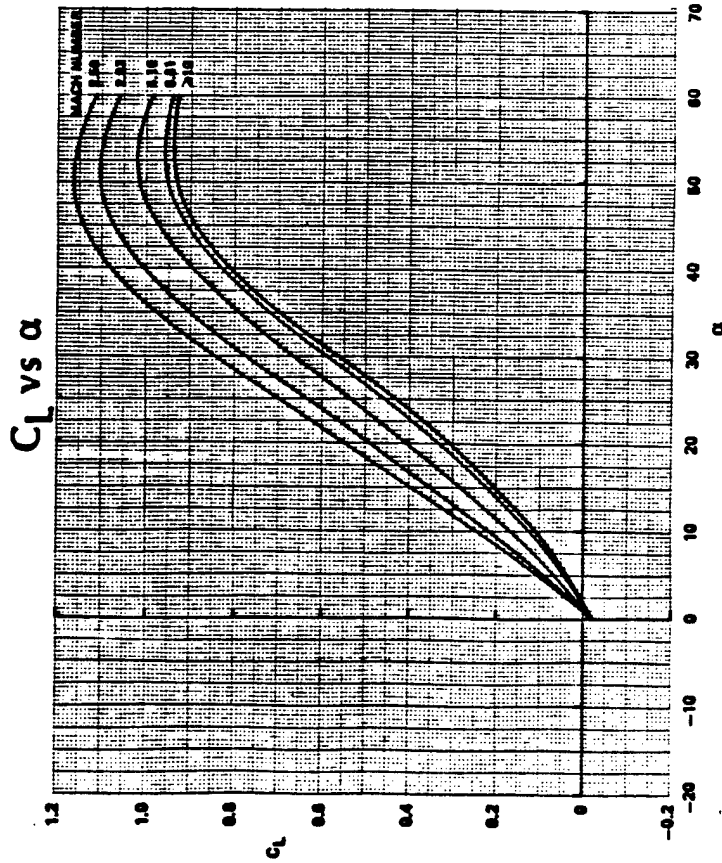

SREF = 2510 FT<sup>2</sup>



BOEING PROPRIETARY

PROPULSION SYSTEM SUMMARY

Model 896-111 (Concept B-1) utilizes a combination of airbreathing and rocket engines. The booster has eight uprated F-101 engines located in two pods of four each. The uprated F-101 has a maximum sea-level static thrust of 35,000 lbs (installed). Current studies indicate that these thrust levels may be possible by increasing the burner temperature of the current engine therefore negating the need for engine uprating. These engines are the primary power source during climb, provide augmented thrust through boost, and remain operating throughout the flight to return booster to the launch site. To maintain the F-101 engines operating throughout the booster flight regime, it may be necessary to burn H<sub>2</sub> during the rocket booster part of the flight. Use of a dual-fuel air-breathing engine will be reviewed as a continuing part of our IR&D studies.

The rocket propulsion system consists of two SSME engines and four advanced RL-10s. The SSMEs, one on both the orbiter and booster, are rated at 112 percent nominal and are expanded 150 to 1. This provides 530,200 lbs vacuum thrust each at an ISP<sub>VAC</sub> of 463.5 seconds. The four advanced RL-10's are located on the orbiter and provide thrust through ascent and OMS in orbit. The engines are uprated to 34,500 lbs of vacuum thrust each at an ISP<sub>VAC</sub> of 430.9 seconds

BOEING PROPRIETARY

# Propulsion System Summary

## ROCKETS

2 - SSME 112%

$T_{VAC} = 530,200 \text{ LB/ENGINE}$

$I_{SPVAC} = 463.5 \text{ SEC}$

$A_E = 87.0 \text{ FT}^2 \text{ (} \epsilon = 150 \text{)}$

4 - RL-10'S (UPRATED)

$T_{VAC} = 34,500 \text{ LB/ENGINE}$

$I_{SPVAC} = 430.9 \text{ SEC}$

$A_E = 6.2 \text{ FT}^2$

## AIR BREATHERS (F-101 UPRATED) MAXIMUM AUGMENTED THRUST

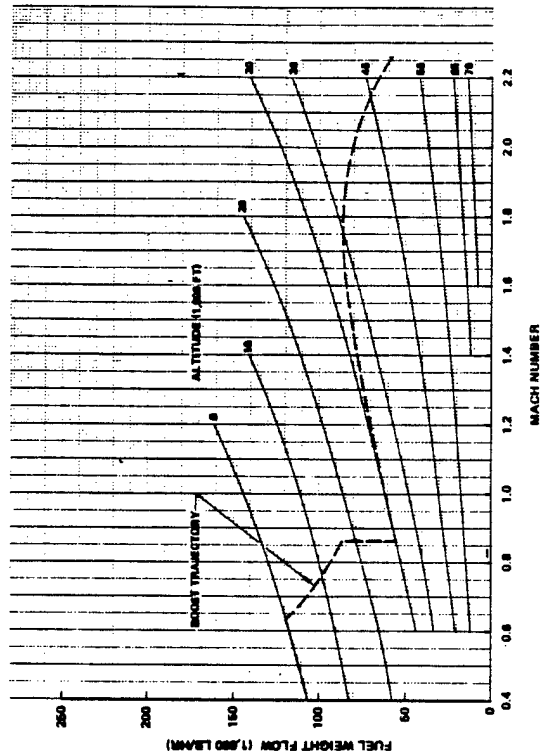
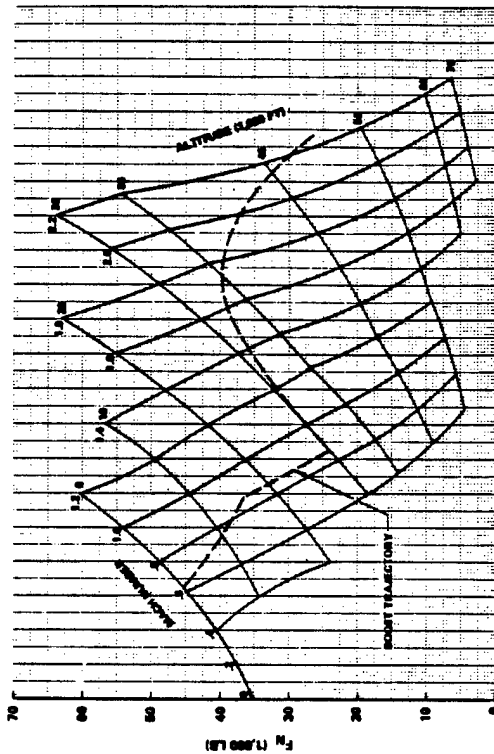

SSME-POWER LEVEL

The key characteristics of the SSME for 100 percent (RPL) and 109% (FPL) of nominal are shown in the figure. The data were provided by Rocketdyne Division of Rockwell International at a Boeing request for a preliminary set of engine parametric data. As noted, Boeing used different values of thrust (530,200 lbs, 112 percent max) and  $I_{sp} = 463.5$  sec than the information provided. Rocketdyne suggested the 112 percent thrust level at an earlier meeting as a technique to improve the thrust/weight ratio during the early part of the launch trajectory. The engine has been tested at 111 percent for approximately 1216 seconds with one high-time engine logging 770 seconds. Rocketdyne believes its use at 112 percent is acceptable in the 1995 time period. The higher  $I_{sp}$  occurs from the use of a 150/1 pure expansion ratio rather than a two-position double bell ( $\epsilon = 55$  to  $\epsilon = 150$ ) system. Upgraded performance will reflect the new  $I_{sp}$  as part of continuing IR&D studies.



SPACE SHUTTLE MAIN ENGINE TEST HISTORY

6-9-83

PROGRAM	ENGINES	TFSTS	SECONDS	FPL SECONDS	111% RPL SECONDS
DEVELOPMENT	17	604	92,700	19,966	72
ACCEPTANCE	16	88	13,436	1,193	
CERTIFICATION (PFC)	4	90	31,820	1,810	
CERTIFICATION (FPLC)	3	66	23,308	14,104	1,144
SINGLE ENGINE TOTAL	40	928	181,264	37,073	1,216
ORBITER GROUND TEST (MPTA)	-	64	10,804	-	
ORBITER GROUND TEST (STS)	-	27	8,514	-	
PROGRAM TOTAL	40	1009	181,582	36,865	
HIGH TIME ENGINES	0002	122	6,125		
	0007	79	14,207		
	2004	48	14,211	1,090	
	2010	43	13,344	8,428	770
TEST STAND DURATIONS (300 SEC)		149			
ORBITER FLIGHT DURATIONS (520 SEC)		145			
FPL ABORT CERTIFICATION (810 SEC)		9			
ABORT TO ORBIT - ATO (665 SEC)		6			
RETURN TO LAUNCH SITE - RTLS (823 SEC)		8			
WORST CASE ABORT TO ORBIT (595 SEC)		5			
RTLS - 1 ENGINE OUT - (760 SEC)		6			

INCLUDES 001-414, 802-313, 750-201, SF-12-1, STS-6

11-88-14

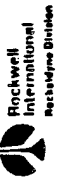

# SSME - POWER LEVEL

D180-27669-4  
145

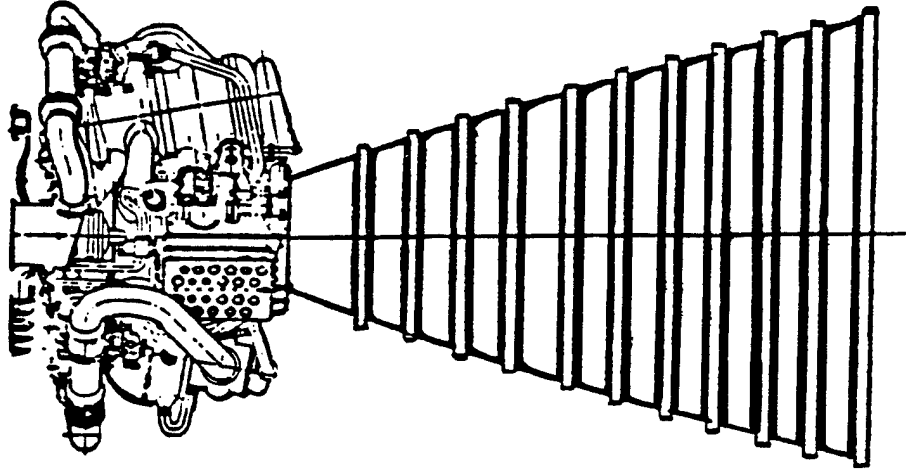

	RPL 100%	FPL 109%
PROPELLANTS	OXYGEN/HYDROGEN	OXYGEN/HYDROGEN
THRUST, LBF		
SEA LEVEL VACUUM	375,000 470,000	516,000 (530,200)*
CHAMBER PRESSURE, PSIA	3012	3287
AREA RATIO	77.5	150
SPECIFIC IMPULSE, SEC		
SEA LEVEL VACUUM	363.2 455.2	395.04 465.7 (463.5)*
MIXTURE RATIO	6.0	6.0
LENGTH, INCHES	167	219
DIAMETER, INCHES		
POWERHEAD NOZZLE EXIT	105 x 95 94	109 x 94.5 126.3
WEIGHT, LBF	6886	6900

\* USED FOR PERFORMANCE CALCULATIONS.  
AN OPTIMIZED TRAJECTORY WITH UPDATED  
I<sub>SP</sub> IS INCLUDED IN APPENDIX B.

308-212G



## SSME PARAMETRIC VACUUM PERFORMANCE

The SSME-150 vacuum ISP improves dramatically with engine throat to exit plane expansion area ratio. Concept B-1 baselined the SSME engine at an expansion area ratio of 150 to 1. Some promise of a lighter weight system or a higher payload may be possible with a higher ratio.

# SSME PARAMETRIC VACUUM PERFORMANCE

D180-27669-4

147

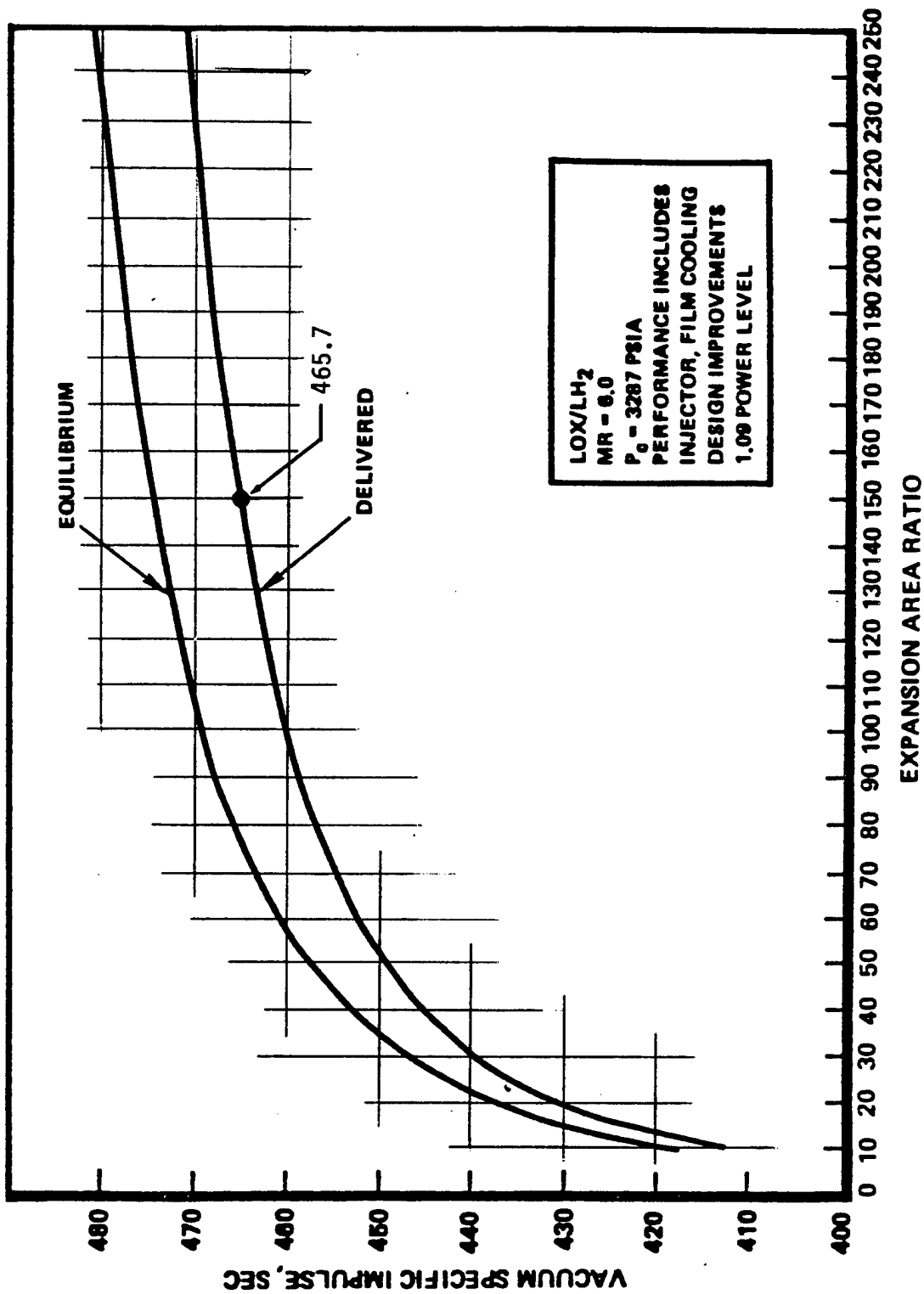

435-733

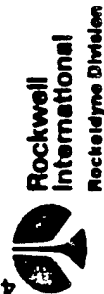

Rockwell  
International  
Rocketdyne Division

## SSME ALTITUDE PERFORMANCE

The altitude effect on engine delivered Isp is shown on the adjacent figure. On Concept B-1, the rocket engines are ignited at 30,000 ft. At this altitude the fuel flow penalty between the existing SSME nozzle, 77.5:1 expansion ratio, and the Concept B-1 engine, 150:1 expansion ratio, is minimal.

# SSME ALTITUDE PERFORMANCE

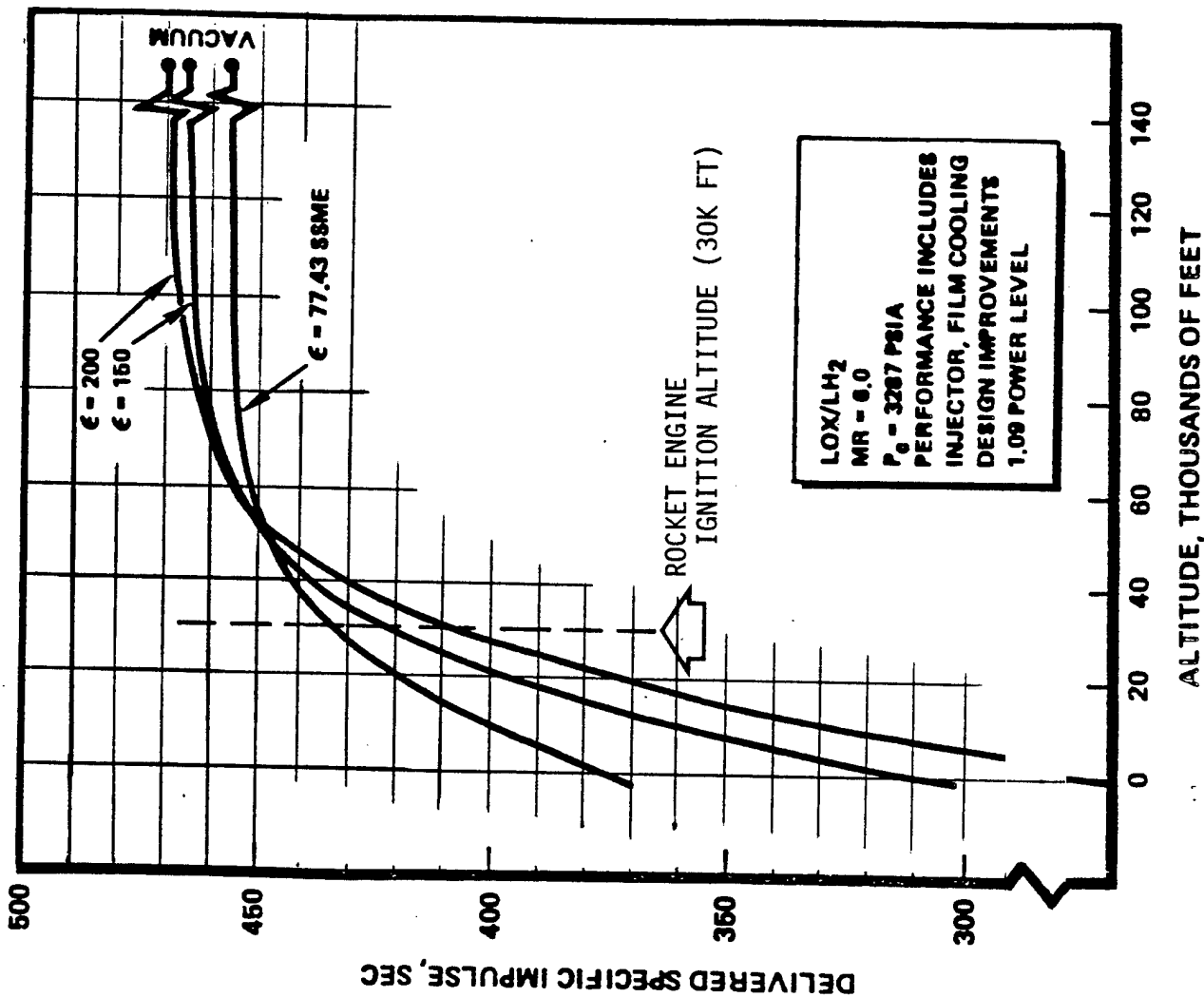



POWER LEVEL, PERCENT SSME THROTTLING PERFORMANCE

Concept B-1 throttles the SSME-150 engine from 112 percent to 65 percent with a constant 6 to 1 mixture ratio to maintain a 3.15 g axial acceleration limit on the orbiter. As shown on the adjacent figure, the ISP penalty for throttling is estimated to be minimal.

# POWER LEVEL, % SSME THROTTLING PERFORMANCE

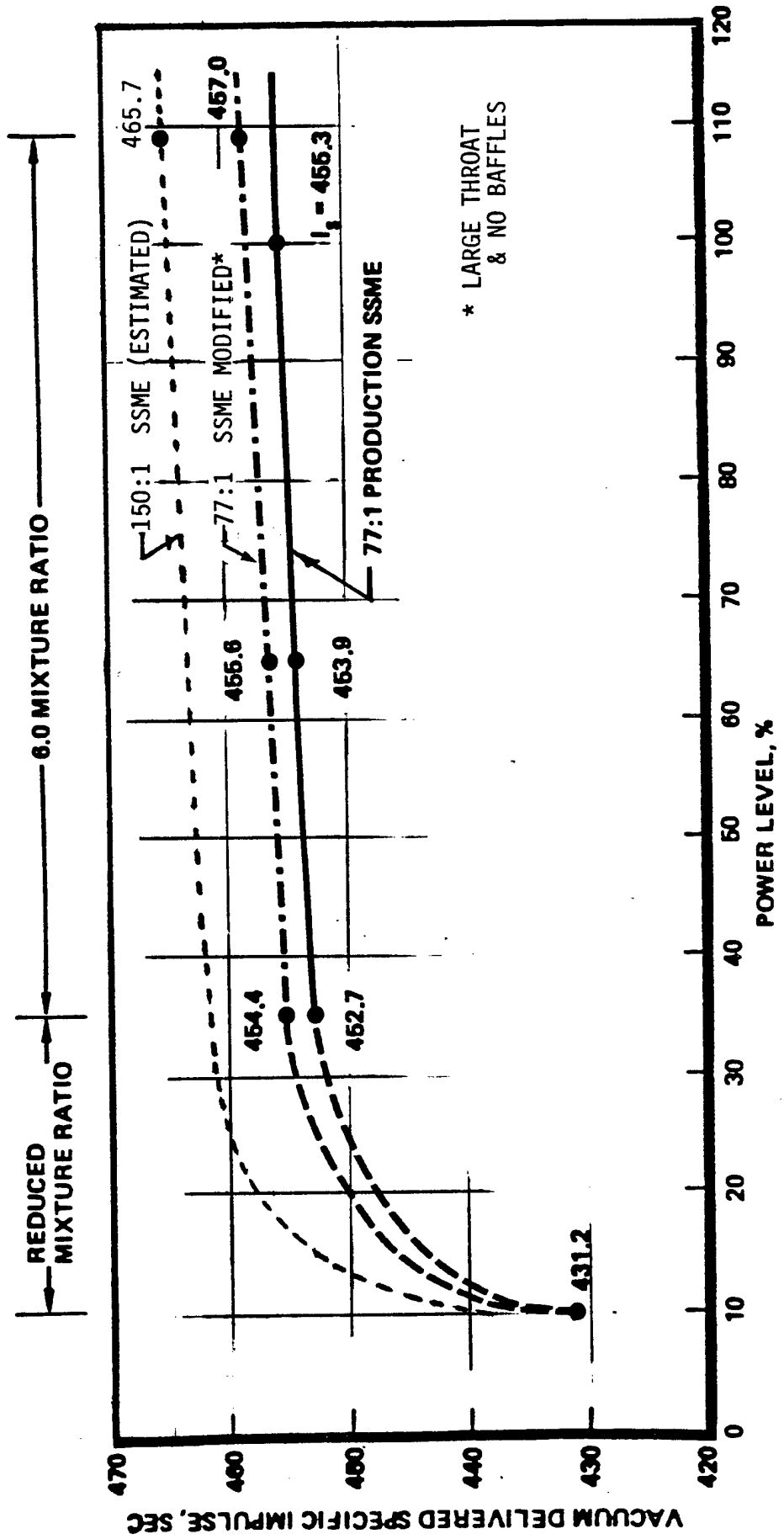

## BOEING PROPRIETARY

## TAV BOOST TRAJECTORY

Model 896-111 (Concept B-1) boost trajectory for the goal mission of once-around polar suborbit is shown. The trajectory begins at 30,000 ft mach = 0.862 with an initial heading of  $-12.7^\circ$ . The first 820.8 seconds of the flight include airbreather start, taxi, takeoff, and climb to 30,000 ft and are not shown on this chart. Included in the trajectory is altitude, velocity, attitude, and thrust histories. At time = 820.8 seconds the vehicles combined weight is 1,185,000 lbs and delivers 1,266,910 lbs of net thrust from the combination of airbreathers and rocket engines. At 882 seconds the airbreathing engines are idled and remain running throughout the flight. Just prior to separation the combined weight of the vehicles is 875,000 lbs. The vehicles separate at 935.54 seconds with the orbiter's propellant tanks full and its initial weight at 577,500 lbs. The orbiter is throttled to a maximum tangential acceleration of 3.15 g's. Selective throttling and subsequent shutdown of the RL-10s enable the SSME to be continuously throttled to 65 percent. This corresponds to the current continuous throttle limit on the engine. At time = 1285.12 seconds the engines are shut down. The weight at engine cutoff is 106,335 lbs which delivers 20,000 lbs payload once-around Earth.

## Definitions:

Velocity R - relative velocity  
 Velocity I - inertial velocity  
 Gamma R - relative flightpath angle  
 Alpha - angle of attack  
 Thrust - net thrust

# BOEING PROPRIETARY

# TAV Boost Trajectory

MODEL 896-111, CONCEPT B-1

TIME SEC	ALTITUDE FEET	VELCVTIV-R FT/SEC	VELCVTIV-I FT/SEC	GAMMA-R DEG	ALPHA CEG	THRUST LBS	RANGE NAUT MI	BANK DEG
820.800	30000.0	457.350	1387.32	0.000000E+00	0.000000E+00	0.126691E+07	67.0000	0.000000E+00
835.800	30827.9	1263.74	1600.00	5.35000	1.50236	0.134530E+07	69.6403	0.000000E+00
850.800	33982.1	1599.28	1829.02	11.1000	1.17037	0.140749E+07	73.1369	0.000000E+00
865.500	40325.2	1904.61	2066.84	16.6501	1.53282	0.141735E+07	77.3303	0.000000E+00
880.400	50572.4	2186.92	2305.34	22.2001	2.72524	0.129932E+07	82.0854	0.000000E+00
895.800	62863.6	2218.73	2333.31	27.9401	3.02069	0.115494E+07	82.7533	0.000000E+00
910.800	75060.5	2377.85	2478.12	32.7501	3.90568	0.117482E+07	87.1818	0.000000E+00
925.476	85912.6	2385.92	2485.60	38.0000	0.000000E+00	0.117566E+07	87.4151	0.000000E+00
940.474	95812.6	2385.92	2485.60	28.0000	3.32255	0.117566E+07	87.4151	0.000000E+00
955.507	105788.3	2635.23	2702.85	28.0000	7.14035	0.119811E+07	92.6171	0.000000E+00
970.507	138855.5	2800.00	2849.31	28.0000	0.000000E+00	0.119222E+07	96.0714	0.000000E+00
985.801	162532.0	2841.33	2893.70	31.1069	21.0886	0.119222E+07	96.0714	0.000000E+00
997.507	185193.0	2651.76	2905.30	32.0000	27.0004	0.119428E+07	98.5692	0.000000E+00
1013.512	208021.0	25800.0	2905.30	32.0000	14.2132	0.119428E+07	99.2787	0.000000E+00

• ORBITER/FLIGHT

935.540	117522.0	3000.00	3039.16	32.0000	16.3663	667006.0	102.509	0.000000E+00
940.000	124595.0	3077.68	3167.10	30.9296	17.0506	667317.0	104.400	0.000000E+00
970.000	171022.0	3736.11	3659.22	23.7295	17.4779	668057.0	119.154	0.000000E+00
1000.000	213712.0	4635.14	4543.94	16.5295	12.6407	668174.0	134.281	0.000000E+00
1030.000	249208.0	5801.90	5666.64	9.32955	6.23163	668195.0	163.005	0.000000E+00
1037.660	256889.0	6144.43	6000.00	7.49184	0.000000E+00	668196.0	170.361	34.7548
1060.000	270393.0	7169.40	7045.75	4.70195	19.1975	668198.0	194.363	30.5897
1078.360	279604.0	8109.04	7999.80	2.94319	24.5306	668199.0	217.074	19.9079
1090.000	284260.0	8727.34	8625.88	2.51870	22.9991	668199.0	232.961	19.8820
1113.190	492365.0	10087.5	9999.74	1.80085	19.0552	668200.0	268.299	21.0810
1120.000	284453.0	10524.7	10446.6	1.58246	19.2926	668200.0	279.680	21.0887
1142.815	299966.0	12073.0	11999.7	0.999615	19.1607	668200.0	320.222	22.3091
1150.000	303995.0	14062.6	13999.5	0.807544	14.3870	668200.0	372.270	23.5382
1166.750	303299.0	15276.0	15217.9	0.489990	12.3329	668200.0	335.976	23.5382
1180.000	305299.0	15276.0	15217.9	0.296096	11.1321	668200.0	403.776	23.9839
1187.930	305852.0	16055.3	16000.0	0.218413	10.2232	652248.0	423.921	24.7543
1207.900	306582.0	18049.1	18000.0	0.392757E-01	9.46730	570900.0	479.144	26.4014
1210.000	306603.0	18259.9	18211.4	0.222920E-01	4.30730	562669.0	485.340	26.6070
1227.770	306371.0	20044.1	20000.0	-0.986672E-01	6.85607	497735.0	540.538	29.0924
1240.000	305864.0	21275.9	21238.4	-0.134773	6.04983	457450.0	581.525	31.3692
1247.580	305459.0	22039.9	22000.0	-0.145678	5.36360	434150.0	608.140	33.3119
1267.340	30436.2	24036.2	24000.0	-0.116342	3.81309	378006.0	682.005	38.7920
1270.000	304220.0	24305.1	24269.2	-0.107437	3.84383	371921.0	692.430	40.5254
1285.812	303821.0	25800.0	25800.0	0.217211E-02	4.05680	335087.0	753.907	50.0666

① INITIATION OF ROCKET BOOST

• INITIAL HEADING = -12.7°

• MAXIMUM TANGENTIAL ACCELERATION = 3.15g

BOOSTER

ISP<sub>VAC</sub> = 463.5 SEC (SSME)

ORBITER

ISP<sub>VAC</sub> = 463.5 SEC (SSME)

ISP<sub>VAC</sub> = 430.9 SEC (RL-10)

## BOEING PROPRIETARY

## TRAJECTORY LOSSES

Detailed breakdown of the trajectory losses is shown for Model 896-111 (Concept B-1) in its goal mission of once-around polar suborbit. Over 57 percent, or 2678 ft/s, of the total ascent velocity losses occur prior to separation. Of these booster losses 46 percent, or 1235 ft/s, are drag losses. This indicates that substantial system improvements can be achieved through drag reduction efforts in further design iterations.

## Definitions:

- G-LOSS - gravitational losses
- D-LOSS - drag losses
- TV-LOSS - thrust vector losses

BOEING PROPRIETARY  
**Trajectory Losses**

MODEL 896-111 CONCEPT B-1

● BOOSTER/ORBITER FLIGHT (LOSSES INITIATED AT 30K AND M = 0.862)

TIME SEC	TOTAL VEL FT/SEC	G-LOSS FT/SEC	G-LOSS FT/SEC	G-LOSS FT/SEC	TV-LOSS FT/SEC	TOTAL LOSS FT/SEC
825.800	0.000000E+00	0.000000E+00	0.000000E+00	0.000000E+00	0.000000E+00	0.000000E+00
835.800	594.015	111.882	23.2882	23.2882	0.508221	186.933
850.800	1235.07	298.329	92.9222	92.9222	0.660147	491.910
865.800	1909.94	511.368	208.201	208.201	0.616243	931.049
880.800	2581.83	711.771	367.950	367.950	1.23118	1250.32
892.800	2865.77	736.324	392.827	392.827	1.33218	1302.42
895.800	3168.94	807.013	370.821	370.821	2.76317	1846.33
896.476	3195.55	894.796	590.617	590.617	2.90682	1644.96
896.476	3195.55	894.796	590.617	590.617	2.90682	1644.96
910.800	3771.64	936.730	795.464	795.464	3.25482	1991.35
919.587	4136.43	1058.36	927.066	927.066	9.54632	2191.52
925.801	4399.95	1159.04	1024.74	1024.74	32.2466	2413.69
927.587	4476.56	1186.30	1053.52	1053.52	41.1644	2479.89
927.587	4476.56	1186.30	1053.52	1053.52	41.1644	2479.89

● ORBITER FLIGHT

935.540	4822.69	1234.98	1180.69	1180.69	55.3720	2677.76
940.000	4989.67	1242.94	1262.73	1262.73	62.4127	2767.06
970.000	6185.08	1267.99	1659.42	1659.42	118.724	3285.90
1000.00	7442.83	1273.39	2025.37	2025.37	163.363	3861.93
1030.00	8842.46	1274.39	2238.53	2238.53	183.116	3893.85
1037.86	9222.13	1274.48	2271.71	2271.71	184.685	3930.70
1060.00	10369.7	1275.20	2345.35	2345.35	251.956	4072.34
1078.36	11423.9	1275.61	2383.36	2383.36	307.258	4166.06
1090.00	12119.4	1275.91	2400.71	2400.71	366.223	4242.67
1113.19	13611.4	1276.39	2427.90	2427.90	469.650	4373.76
1128.00	14080.4	1276.51	2434.18	2434.18	494.316	4404.84
1142.15	15717.4	1276.84	2449.60	2449.60	566.094	4492.77
1150.00	16344.2	1276.94	2453.46	2453.46	566.818	4517.06
1166.75	17774.9	1277.15	2459.30	2459.30	626.719	4563.00
1180.00	19021.9	1277.30	2462.09	2462.09	652.684	4591.91
1187.93	19616.8	1277.38	2463.19	2463.19	666.680	4607.10
1207.90	21640.5	1277.62	2464.55	2464.55	693.874	4635.88
1210.00	22053.4	1277.65	2464.59	2464.59	696.155	4638.23
1227.77	23654.9	1277.91	2464.22	2464.22	712.201	4654.17
1240.00	25094.7	1278.14	2463.45	2463.45	720.680	4661.49
1247.58	25624.6	1278.30	2462.87	2462.87	724.002	4665.01
1267.34	27466.3	1278.82	2461.35	2461.35	731.221	4671.23
1270.00	28135.6	1274.90	2461.19	2461.19	731.822	4671.76
1285.12	29666.5	1279.46	2460.69	2460.69	735.455	4675.45

BOEING PROPRIETARY

TRANSATMOSPHERIC VEHICLE LOSSES

The accumulation of total losses as a function of relative velocity is shown with time intervals indicated. This graphical presentation reinforces the disparity of losses between the booster and the second stage. Another interesting feature is the radical slope change at 919.6 seconds. These additional losses are attributed to thrust vectoring and gravitation losses associated with meeting flightpath angle requirements for separation.

BOEING PROPRIETARY  
**Transatmospheric Vehicle Losses**

CONCEPT B-1

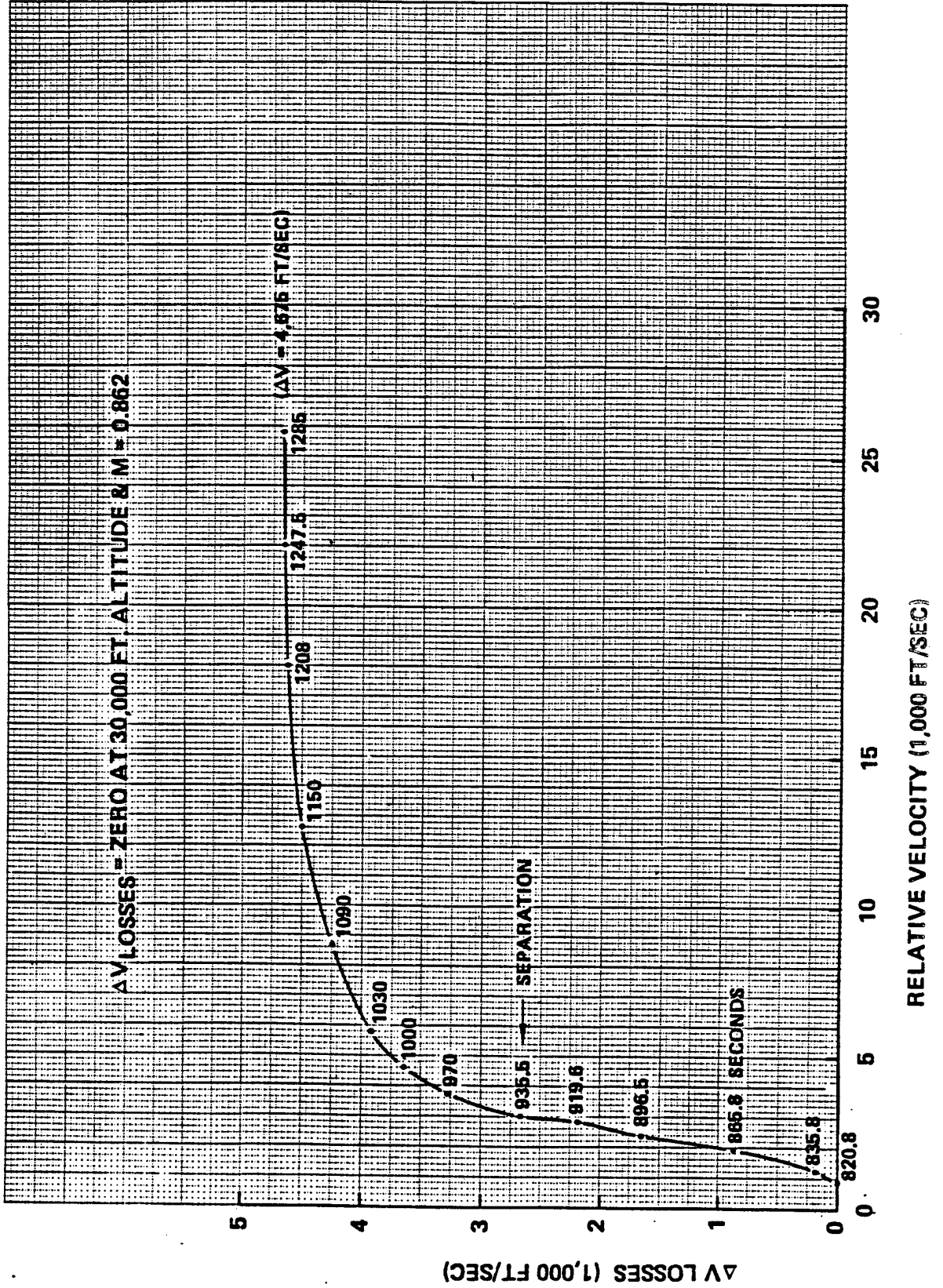



## PAYLOAD DENSITY HISTORY

The corresponding payload density trend was used to establish base point design payload density for TAV orbital stages. Payload bay data used to define the trend are also included.

# Payload Density History

PROGRAM	PAYLOAD BAY DATA			LB/FT <sup>3</sup> DENSITY AVR
	WT LB	VOL. FT <sup>3</sup>		
SHUTTLE	65K	10,603 (15 X 60)		6.13
RASV	20K	1,571 (10 X 20)		12.6
SORTIE	3K	135 (4½ X 8½)		22.2
SEP. STUDY	5K	577 (7 X 15)		8.66
LANGLEY	25K	3,534 (15 X 20)		7.07
747F	253K	22,890		11.05
727F	34,994	4,166	} COMM. DATA	8.4
707F	84,588	7,420		11.4
737F	36,300	3,745		9.7
DESIGN POINT	20,000	2,000 (11 X 21)		10.0

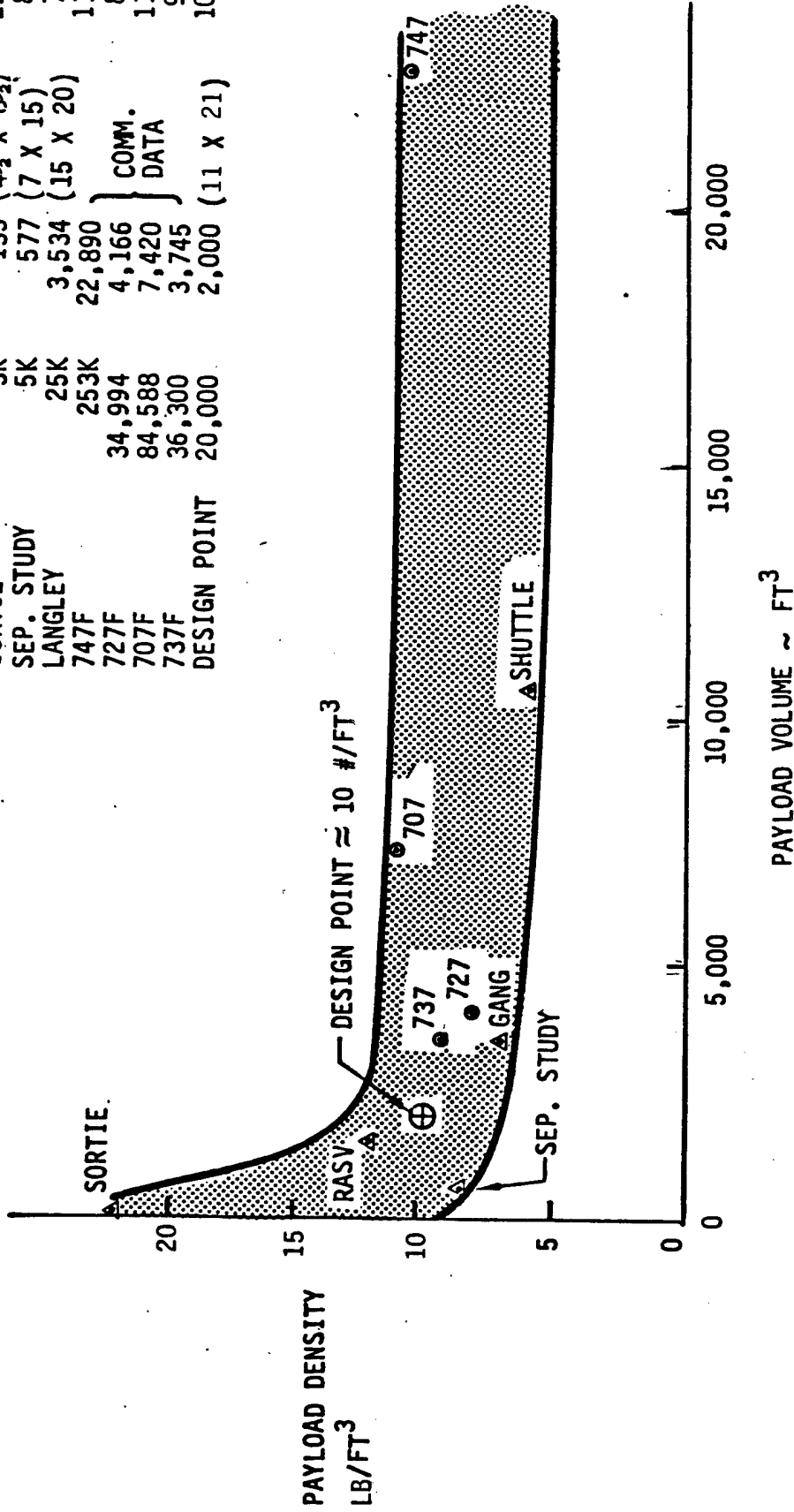

PAYLOAD VOLUME ~ FT<sup>3</sup>

#### PRELIMINARY DESIGN WEIGHT PROGRAM

There are several basic elements that make up the PDWTS computer program package: The data dictionary (DICTION), the PDWTS input data file editor (PEDIT), and the mass property program itself (PDWTS). A schematic illustrating the relationship of these elements is presented.

One of the primary advantages to this system is that it produces a consistent data base. This is a prime prerequisite for any concept evaluation. It allows the user the advantage of investigating the effects of special features (nuclear hardening, advanced technology, etc.) but requires the user to understand the basic limitations of individual component weight estimating methods included in the total program. Engineering judgment and mass property prediction experience must be applied to produce acceptable data.

TAV concepts have added the requirement of defining additional component weight estimating methods to the existing PDWTS program.

Boeing IR&D efforts are currently directed toward expanding orbiter weight prediction methods in order to allow the development of orbiter weight and mass property descriptions similar to the booster design weights program shown.

# Preliminary Design Weights Program

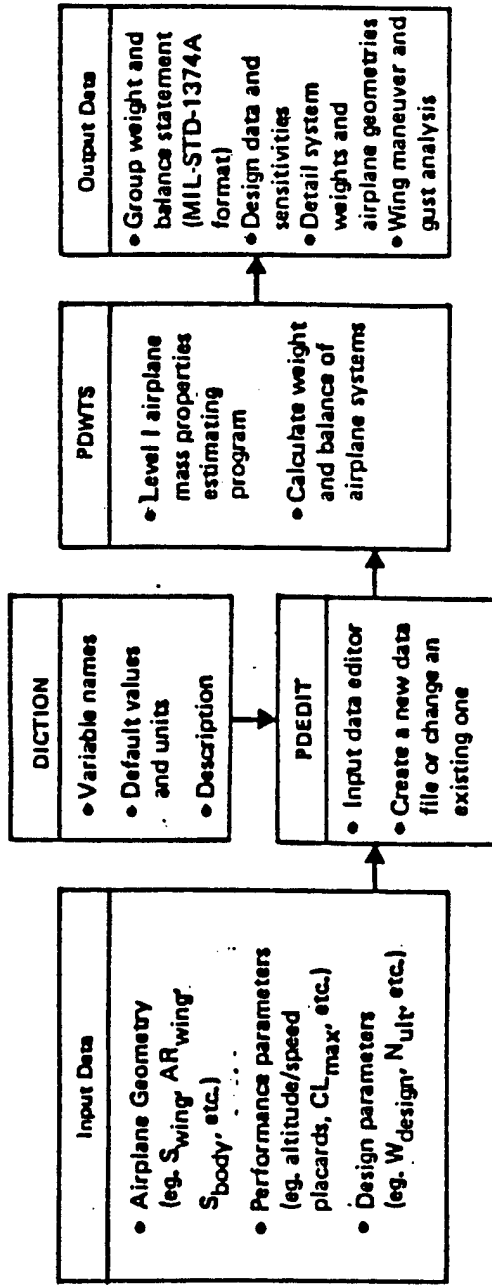

- o INPUT DATA - ALLOWS INVESTIGATION OF 322 VARIABLES TO DEFINE A SPECIFIC CONFIGURATION
- o PD EDIT - STORES ANY CONFIGURATION AND PROVIDES ABILITY TO EVALUATE IMPACT OF VARIATIONS
- o PD WTS - CONDUCTS WEIGHT ANALYSIS USING WEIGHT ESTIMATING METHODS FOR INDIVIDUAL COMPONENTS OR SUBSYSTEM. THE WEIGHT DATA BASE WAS DEVELOPED USING CORRELATIONS OF DESIGN PARAMETERS WITH BROAD BASE OF AIRCRAFT HARDWARE PROGRAMS (DOCUMENTED WEIGHT PREDICTING METHODS)
- o OUTPUT DATA - AS SHOWN ABOVE

## OPERATING WEIGHT STUDIES

The adjacent weight trades were developed for Model 896-104. They assume a constant landing weight and only show the booster weight change associated with the variable change. These would be an additional weight change associated with vehicle gross weight to obtain the same performance (fuel, propellant, and their associated provisions).

The weight trends shown are indicative of the changes expected for the Model 896-111 Booster. A load factor evaluation for this booster at a limit value of 2.5 yielded an OW change of +13,430 lbs and a wing weight change of +11,510 lbs compared to 896-104 comparable values of +12,600 and +11,200 lbs.

Gross weight variations with a fixed change in OW due to a modification are +0.8 lbs/lb. This assumes a constant weight or performance upper stage. The +0.8 lbs is broke down into +0.2 lb of structure and equipment (OW) and +0.6 lbs of rocket propellant and JP4. This again assumes a constant landing weight.

# Operating Weight Studies

(LANDING WEIGHT CONSTANT)

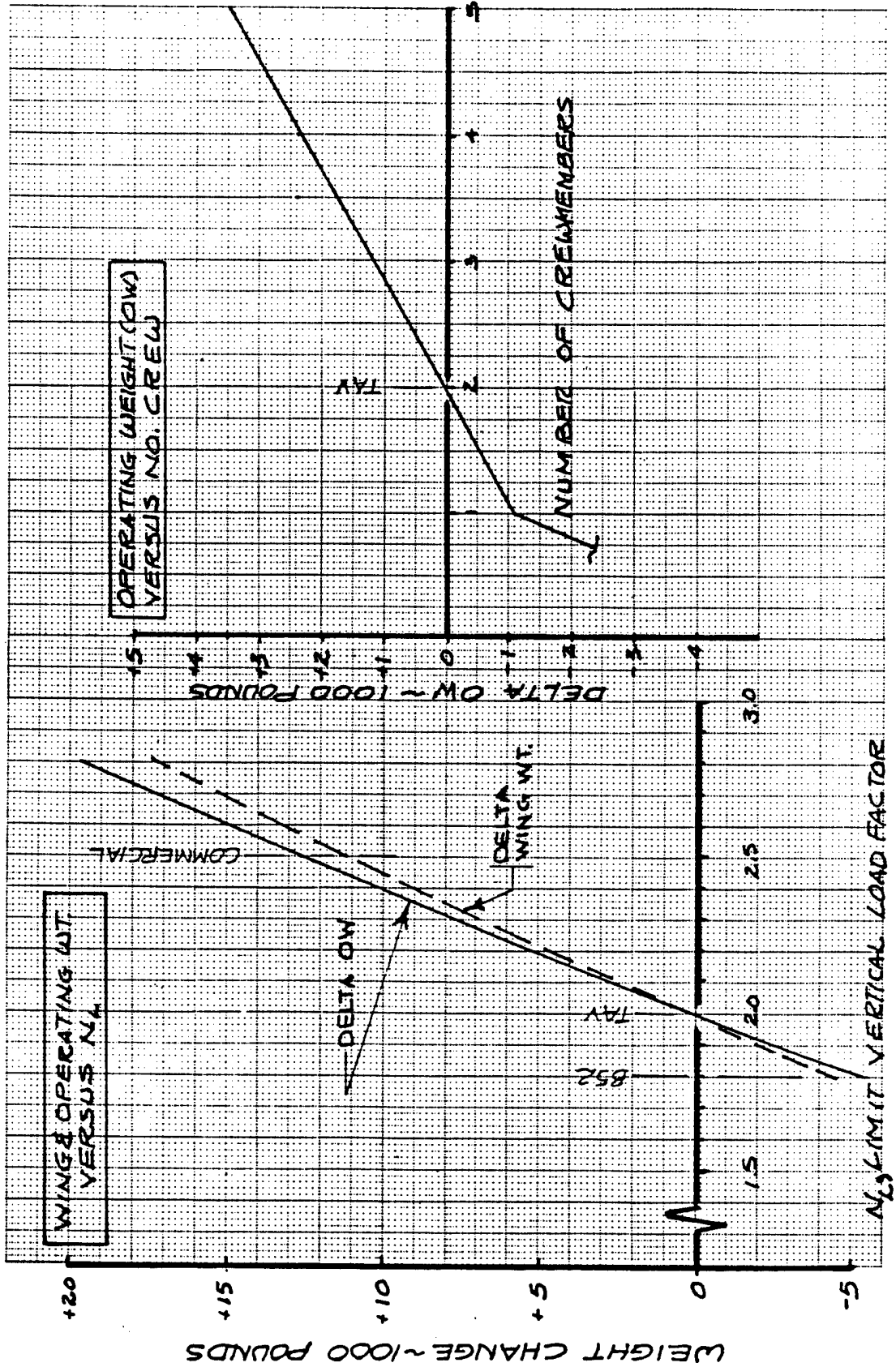

## WEIGHT VERIFICATION - HISTORICAL DATA

The attached plot illustrates general trending of the ratios of actual Operating Weights to Design Gross Weights plotted against Design Gross Weights for a variety of aircraft. The same relationships are shown for rocket powered reusable/expendable booster concepts.

This plot encompasses a design state-of-the-art period of more than 30 years and contains aircraft that cover a broad spectrum of design features such as speed, range, payload and design structural load factors. A weight trend line for cargo aircraft was generated as an attempt to normalize some of the variables.

Boeing TAV orbiter and booster plot points indicate (1) the estimated orbiter weight is compatible with actual vertical takeoff expendable systems with allowances for reusable vehicle features such as wing, thermal protection and landing gear and (2) booster estimated weight data, while slightly lower than mean values for cargo airplanes, appear to be a reasonable 1995 IOC goal.

# Weight Verification - Historical Data

1 F-86	17 810	25 TRIDENT 1F	33 B047B	41 990A	49 B-52H	58 E-16A
2 F-102A	18 C-119G*	26 B29A	34 C-124C*	42 DC-8	50 748B-50	59 C-160*
3 JET STAR	19 BAC-111	27 377	35 880	43 707-420	51 747	60 C-97A*
4 GULFSTREAM	20 AM-650	28 727	36 B-47E	44 VC-10	52 C-2A*	61 C-130E*
5 F-100F	21 CARAVELLE	29 MK-4	37 720	45 C-14A	53 C-131A*	62 C-135A*
6 F-27	22 749A	30 YB-58A	38 720B	46 707-320C	54 SST	63 C-133A*
7 F893	23 ELECTRA	31 COMET4C	39 C-133	47 B-36D	55 C-54G*	64 C-5A*
8 F106B	24 DC-7B	32 B-50B	40 707-120	48 B-52D	56 C-119G*	65 747-200F*

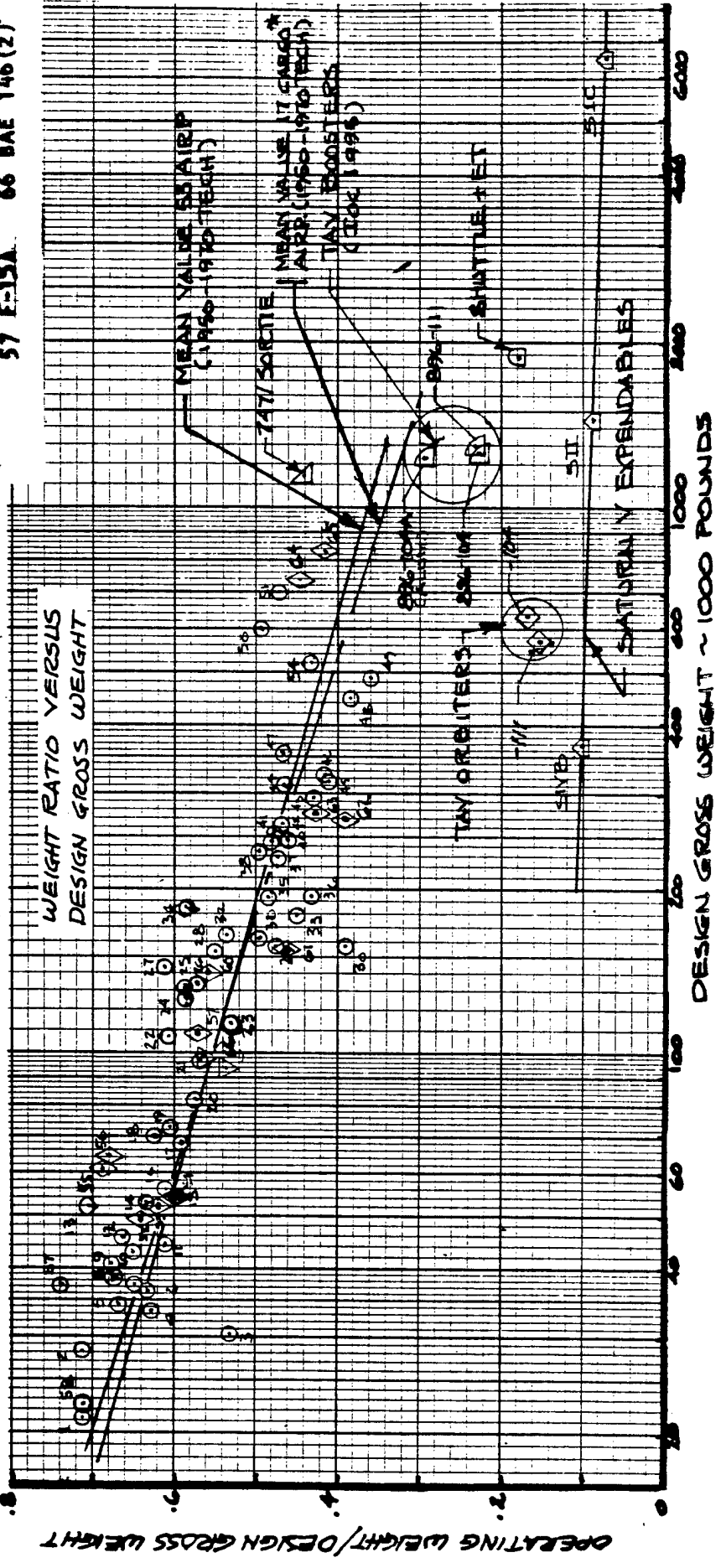



### **3.1.3 Cost Analysis**

# Preliminary TAV System Costs (1983 Dollars)

- BOEING AEROSPACE PARAMETRIC COST MODEL (PCM) - USED FOR ORBITER - CALCULATES DDT&E COSTS AND VEHICLE PRODUCTION COSTS. INPUTS ARE DRY WEIGHT BREAKDOWN, WRAP RATES & FACTORS, COMPLEXITY FACTOR ESTIMATES (RELATIVE SCALE), MATERIAL FACTORS, LEARNING CURVES, SCHEDULE FACTORS, COMMONALITY FACTORS. OUTPUTS ARE ENGINEERING AND DEVELOPMENT SHOP MANHOURS AND DOLLARS, MFG., BASIC FACTORY LABOR HOURS AND DOLLARS AND SUPPORT COST DOLLARS.
- BOEING MILITARY AIRPLANE (ATACM) COST MODEL - USED FOR BOOSTER - CALCULATES DDT&E COSTS AND VEHICLE PRODUCTION COSTS FOR AIRFRAMES (LESS ENGINES & AVIONICS). INPUTS ARE A.M.P.R. WEIGHT BREAKDOWN, SPEED, LEARNING CURVES, AIRFRAME QUANTITY, COMPLEXITY FACTORS, TECHNOLOGY AVAILABILITY DATE, MATERIAL WEIGHTS, OUTPUTS ARE ENGINEERING, DEVELOPMENT TOOLING AND PRODUCTION HOURS AND DOLLARS AND MATERIAL DOLLARS FOR DDT&E AND PRODUCTION QUANTITIES.
- MODELS UTILIZE CER'S REFLECTING BOEING AND INDUSTRY EXPERIENCE - CER'S DEVELOPED BY BOEING AND RAND CORPORATION USING MULTIPLE REGRESSION ANALYSIS OF WEIGHT, SPEED, ETC., TO DEVELOP HOURS PER LB., DOLLARS PER LB., DOLLARS PER HOUR, ETC.
- BOOSTER DDT&E COSTS CORRECTED FOR LOW PRODUCTION RATES - LEARNING CURVES FOR COST/QUANTITY CALCULATIONS WERE ADJUSTED (FLATTENED) BECAUSE OF LOW RATE (10 VEHICLES PER YEAR) PRODUCTION. MOST BOEING AIRFRAME CER'S REFLECT RATES OF 3 TO 10 OR MORE PER MONTH.
- BOOSTER/ORBITER RATIO EQUALS - 3 BOOSTERS/10 ORBITERS. (ONE BOOSTER/BASE WITH 5 BOOSTERS AS FLEET SPARES) SPARE BOOSTERS FERRIED TO OPERATIONAL BASES AS REQUIRED.
- VALUES OF MAJOR DESIGN AND PROGRAM COST DRIVERS ARE BASED ON PRELIMINARY DESIGN ASSUMPTIONS. VALUES (AND COSTS) WILL VARY WITH FURTHER DEFINITION OF THE TAV SYSTEM.
  - TWO FLYABLE TEST SYSTEMS AND ONE FULL VEHICLE FOR GROUND TEST
  - MINIMIZATION OF THERMAL PROTECTION SYSTEM REQUIREMENTS IS AN ASSUMED DESIGN GOAL
  - STATE OF THE ART TECHNOLOGY IS ASSUMED ADEQUATE TO DEVELOP AND PRODUCE THE TAV SYSTEM IN THE 1995 TIME PERIOD
  - MAXIMUM UTILIZATION OF EXISTING PROPULSION SYSTEMS (E.G., SSME AND UPRATED F101) IS A GROUND RULE.

TOTAL VEHICLE INVESTMENT COSTS AS A FUNCTION OF  
NUMBER OF VEHICLES IN THE FLEET BY THE YEAR 2000

Boeing's costing concept envisions design and construction of limited production tooling in the DDT&E phase as the basis for manufacture of flight and ground test vehicles. This limited production tooling is assumed adequate to support low rate production of less than one vehicle per month.

In compliance with paragraph 2.3 of the referenced letter these tooling costs for both orbiter and booster which are part of "Test Articles Fabrication and Technology Development" are also included in the hardware investment curves shown here.

All plots (orbiter, booster, and total) are against the number of TAV orbiters, assuming a constant ratio of 3 boosters to 10 orbiters.

Reference: Battelle Columbus Laboratories Letter BCD-SSS-TAV-HHC-ICM-83-1 dtd August 8, 1983, Subject: Life Cycle Costing for TAV Concepts

# Total Vehicle Investment Costs as a Function of Number of Vehicles in Fleet by the Year 2000

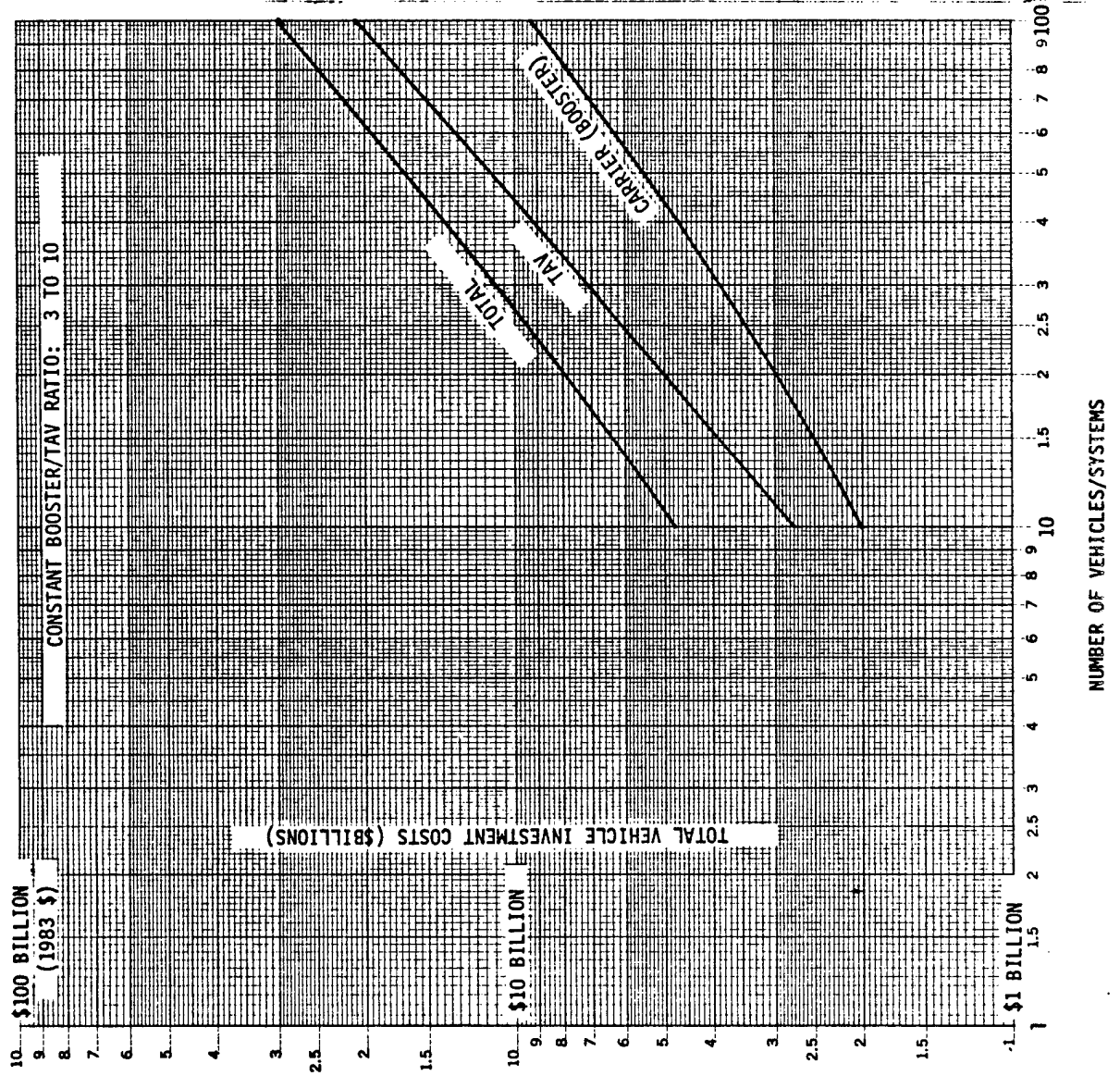

BOEING PROPRIETARY

TOTAL FACILITY INVESTMENT COSTS AS A FUNCTION OF  
NUMBER OF VEHICLES IN THE FLEET BY THE YEAR 2000

The facility costs for the initial 50 systems assume sequential base activation of 10 bases with 5 TAV systems as the initial base complement. Additional TAV systems (up to 5 additional per base) are deployed after all 10 bases are in operation.

Common propellant storage and pumping facilities are included in the total (system) curve and excluded from the TAV (orbiter) and carrier (booster) curves.

Each storage and plumbing facility was assumed to include 6 Dewars, piping and a GH<sub>2</sub> liquifier. \$25 million per base is included as a rough approximation of these facility costs. Further definition of this facility was not available for costing.

JP4 fuel for booster airbreathing engines is assumed available from existing base facilities.

# Total Facility Investment Costs as a Function of Number of Vehicles in Fleet by the Year 2000

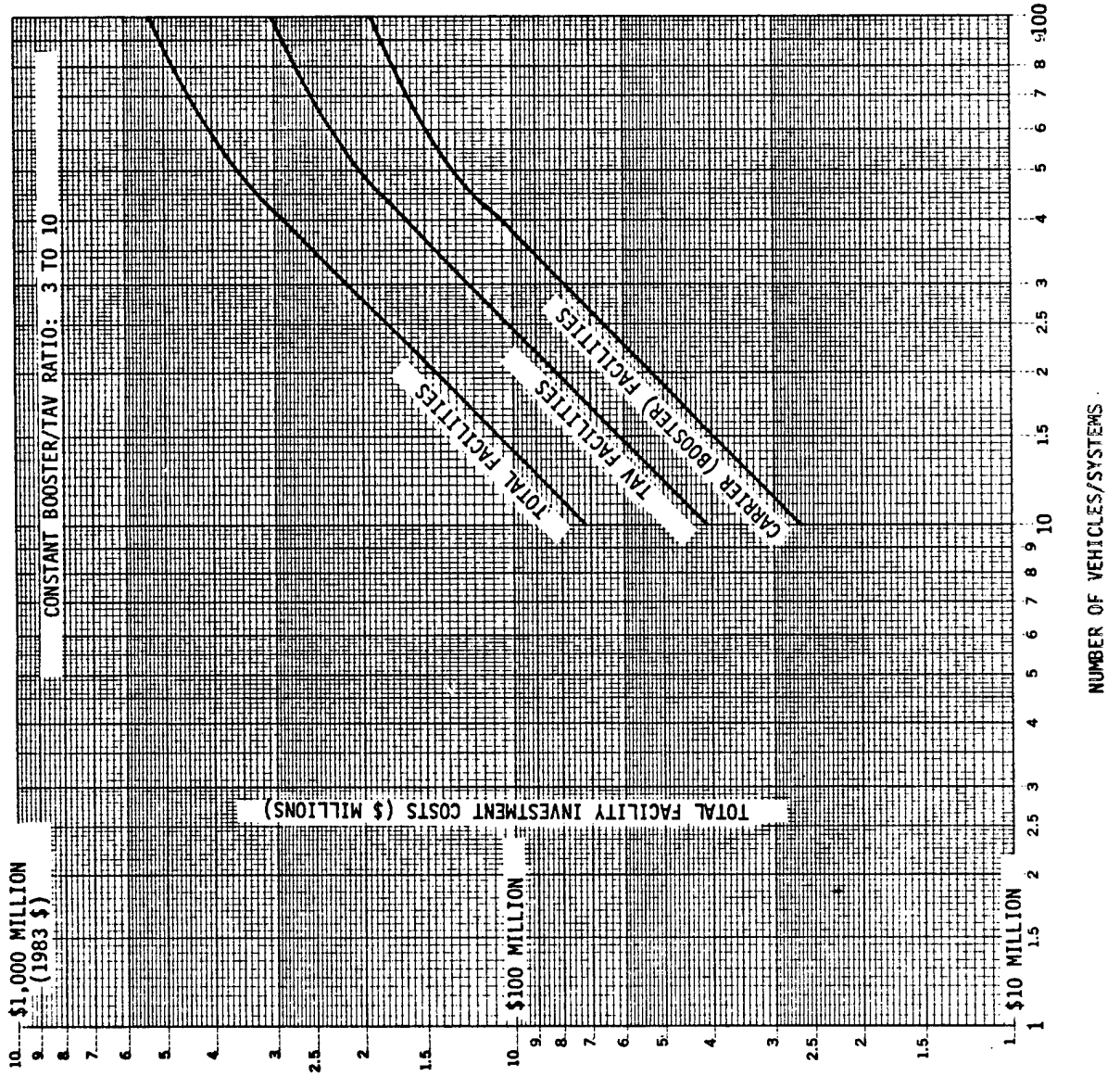

**BOEING PROPRIETARY****TAV OPERATIONAL COSTS AS A FUNCTION OF NUMBER OF VEHICLES AND NUMBER OF FLIGHTS**

Operational costs of propellant and of spares/maintenance of propellant storage and pumping facilities were based on "per flight" consumption rates and varied proportionately with the number of flights.

Other operational costs (personnel, spares/maintenance and other) were varied with both number of vehicles and utilization.

Other scenario assumptions were:

- a. Sequential activation of 10 bases for first 50 systems produced.
- b. Twenty-year operational cost of \$540 million per base for first 10 bases (assuming baseline scenario of 5 systems per base and 2 flights per orbiter per year).
- c. Operational cost per system of systems 51 through 75 estimated to be 60% of average for first 50 systems (assuming same utilization and no additional bases).
- d. Operational cost per system of next 25 systems (76 to 100) estimated to be 60% of average for systems 51 to 75 (assuming same utilization and no additional bases).
- e. Variances in operational costs due to changes in utilization were based on following assumed factors (applied to baseline):

	Cost Element		
	<u>Personnel</u>	<u>Propulsion</u>	<u>Spares/ Maintenance</u>
1 flt/veh/yr	.88	.50	.75
2 flt/veh/yr	Baseline	Baseline	Baseline
5 flt/veh/yr	1.80	2.50	2.20
10 flt/veh/yr	3.50	5.00	4.00
15 flt/veh/yr	4.90	7.50	5.20
20 flt/veh/yr	6.13	10.00	6.65

Cost curves could vary significantly with increased definition of system, missions, and operational scenario.

BOEING PROPRIETARY

# TAV Operational Costs as a Function of Number of Vehicles and Number of Flights

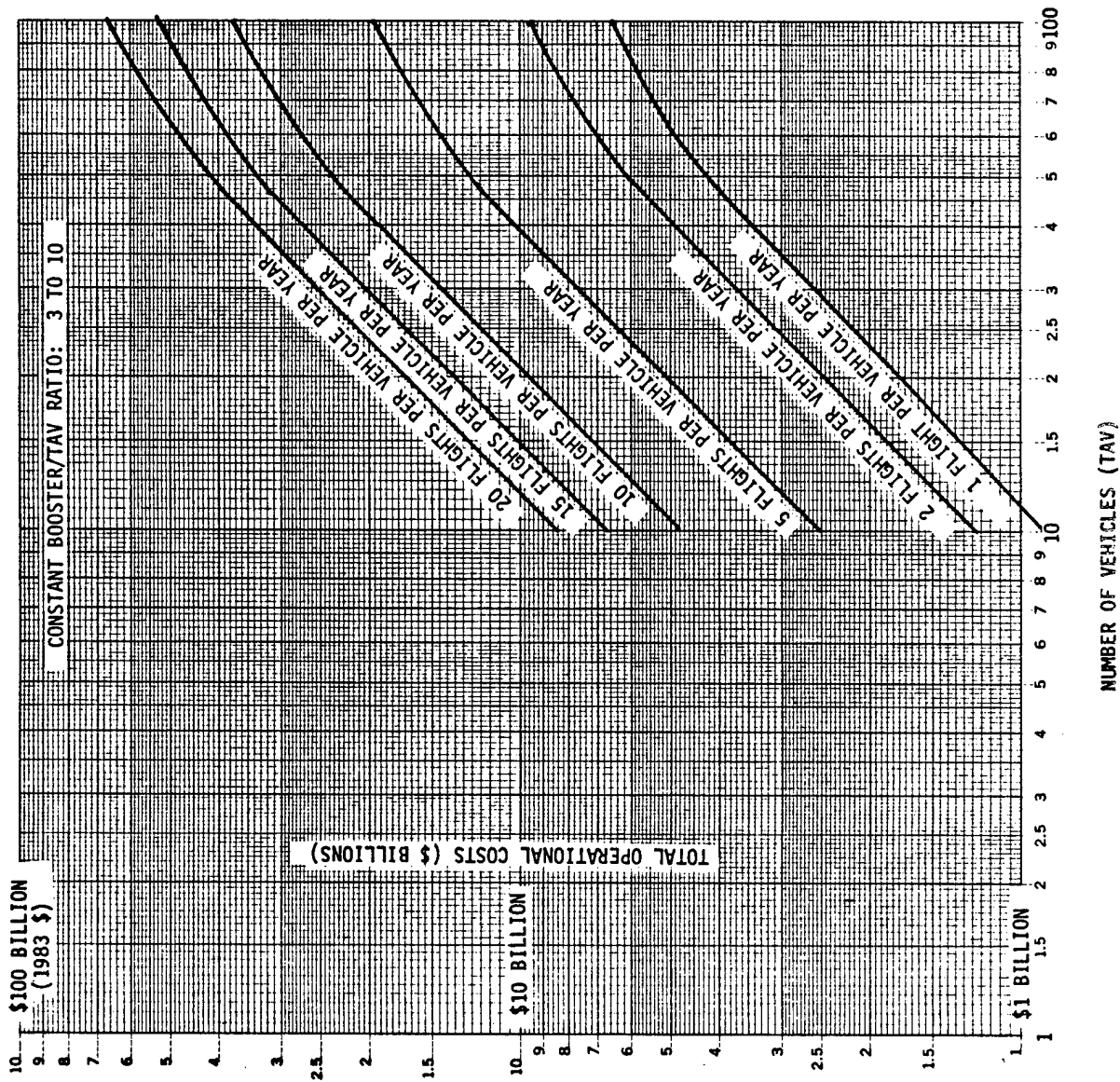



THIS PAGE INTENTIONALLY LEFT BLANK

## PRELIMINARY TAV SYSTEM COSTS (1983 DOLLARS)

DDT&E COSTSSYSTEMS DESIGN

- o TAV orbiter design was estimated using Boeing Aerospace Company's Cost Model (PCM). The model contains CERs derived from industry space and missile programs. Inputs in this case are dry weight breakdown, wrap rates, design complexity factors, material factors and hardware specifics. Outputs are design and development shop hours and dollars.
- o TAV booster design was estimated using Boeing Military Airplane Company's "Advanced Technology Airframe Cost Model" (ATACM). Inputs in this case are AMPR weight breakdown, speed, technology availability date, airframe type, design complexity factors, and materials mix. Outputs are design and development manhours and dollars.
- o "Other" system design is wind tunnel effort in support of aerodynamics and separation technology based on analogy to other wind tunnel programs.

TEST ARTICLES FABRICATION AND TECHNOLOGY DEVELOPMENT

- o TAV Orbiter: Two flight test vehicles and ground test hardware equivalent to one vehicle were estimated by PCM. Limited tooling (for low rate production) is included. Additional model inputs are quantities, schedule factors, and learning curves. Outputs are hardware costs and tooling costs.
- o TAV Booster: Two flight test vehicles and one (equivalent ground test vehicle were estimated by ATACM. Limited tooling (for low rate production) is included. Additional inputs are quantities, schedule factors, and learning curves. Outputs are hardware costs and tooling costs.

GROUND & FLIGHT TESTS AND EVALUATION

- o TAV Orbiter test costs estimated by PCM. PCM is a program model which contains CER's which derive these costs from above inputs.
- o TAV Booster test costs estimated by ATACM. ATACM is a program estimating model which contains CER's which derive test costs.
- o "Other" testing of mated system and separation actuation estimated using CER's developed from other Boeing ground test and flight test programs.

# BOEING PROPRIETARY

## TAV COSTING METHODOLOGY

### HARDWARE/FACILITY INVESTMENT COSTS

#### PREPRODUCTION FACILITIES

- o Existing Boeing facilities are believed adequate to design and produce the TAV system.

#### VEHICLE PRODUCTION

- o TAV orbiter manufacture was estimated by "PCM." Manufacturing cost routines of the model are sensitive to inputs for weight, manufacturing complexity, technology platform, materials, automation factor, off the shelf assumptions and learning curves. Curve slopes were adjusted (flattened) from 85% to 90% consistent with limited tooling for low production rate.
- o TAV Booster manufacture was estimated by "ATACM." The model is sensitive to weight, speed, technology availability, airframe type, materials, complexity to manufacture and learning curve. Curve inputs were adjusted from 80% to 85% for limited (low rate) production concept.

#### AIR FORCE FACILITIES

- o "Peculiar" facilities costs for the TAV program are rough order of magnitude estimates. Maximum utilization of existing SAC base facilities is assumed along with adaptation of facilities made available by phaseout of other systems.
- o TAV Orbiter: Major work statement items are "visually clean" maintenance and payload integration hangars (one per base).
- o TAV Booster: Major work statement item is modified B-52 nose dock (one per base).
- o "Other": Major system item is liquid propellant storage and pumping facility at each base. Fuel is assumed available from suppliers in 1995-2015 time period. No production facilities in the estimate.
- o Support Equipment: Major items envisioned are command and control and data reduction hardware and software. \$ 10 million per base.

BOEING PROPRIETARY

TAV COSTING METHODOLOGY

OPERATIONS COSTS

PERSONNEL

Manpower estimates from integrated logistics support group. Rates and factors applicable to personnel cost are from 1 Feb 82 edition of AFR 173-13

<u>FUNCTION</u>	<u>OFFICER</u>	<u>ENLISTED</u>	<u>CIVILIAN</u>
Flight Crew	24	---	---
Maintenance	8	150	1
Wing/Base Staff	10	26	2
Weapon System Security	1	40	--
Payload	2	10	1
Total Direct	45	226	5
Base Support Indirect	2	40	10
GRAND TOTAL	47	266	15

TAV COSTING METHODOLOGY (Cont'd)

TAV SYSTEM PROPELLANTS

Propellant costs are based on utilization requirements (including losses) for 100 flights annually or a period of 20 years. O&M crews and maintenance and spare parts for the propellant storage and pumping facilities are included.

REPAIR PARTS/SPARES (maintenance spares)

- o TAV Orbiter Fleet: Costs were estimated using replenishment spares CER's developed for SAMSO by The Aerospace Corp., "STS Cost Methodology," 21 Aug 70.
- o TAV Booster Fleet: Cost estimates developed using CER's developed for SAMSO by The Aerospace Corp. under contract F04701-70-C-0059, 31 Aug 70.
- o "Other": A rough order of magnitude allowance of \$2 million/year/base is made for maintenance and updating of hardware and software in the system command/control and data reduction facilities.

OTHER

Factored costs in the "Other" category are based on standard LCC techniques for including base maintenance materials and replacement training for flight and maintenance crew personnel. Per AFR 173-13 dated 1 Feb 82.

# Preliminary TAV System Costs (1983 Dollars)

Cost Category	Costs in Millions \$				Comments
	TAV Orbiter	Booster/Carrier Systems	Other	Total	
<b>DDTAE Costs</b>					
Systems design	1,727	1,794	64	3,585	3 Vehicles Equip., 2 Flight 1 Test
Test Articles Fabrication and Technology Development	1,240	1,701	91	3,032	
Ground & Flight Tests and Evaluation	377	109	40	526	
<b>Subtotal</b>	3,344	3,604	195	7,143	
<b>Hardware/facility Investment Costs</b>					15 Boosters/ 50 Orbiters @10 Vehicles/Yr.
Preproduction Facilities	-NONE	(BOEING FACILITIES AVAILABLE)			
Vehicle Production	11,110	4628	0	15,738	
Air Force Facilities	101	77	253	431	
Support Equipment	104	55	106	265	
<b>Subtotal</b>	11,315	4760	359	16,434	
<b>Operations Costs</b>					10 Bases 100 Flights/Yr. for 20 Years LH <sub>2</sub> - \$1.10/lb LOX - \$.05/lb
Personnel (Number/Type/Costs)	-	-	1360	1360	
TAV System Propellants	-	-	743	743	
Repair Parts/Spares	1,444	1,477	400	3,321	
Other	-	-	720	720	
<b>Subtotal</b>	1,444	1,477	3,223	6,144	
<b>Scenario TAV Program Totals</b>	16,103	9841	3,777	29,721	
Government Program Management Office	459	259	-	718	

## TAV PROGRAM PLAN

A program plan for Concept B-1 is shown on the adjacent page. The major milestones were arrived at by assuming a USAF IOC need date of 1995. Then a DDT&E program was derived based on three key items: 1) the flight test vehicle would be modified to be the first vehicle into the operational fleet (all subsequent operational vehicles would be produced from a concurrent production program--not shown on the chart) 2) an eighteen month flight test program, and 3) a C/A award to first flight time of forty-eight months (typical commercial airplane development schedule). The competitive demonstration and validation was judged to take approximately twenty-four months to complete. However, an overlap between the DDT&E and the validation would be a reasonable program. Finally, experience dictates a concept definition (C.D.) phase of eighteen months will be required to firm up the key technology risks and a planned program for eliminating the risks.

# TAV Program Plan

CONCEPT B-1

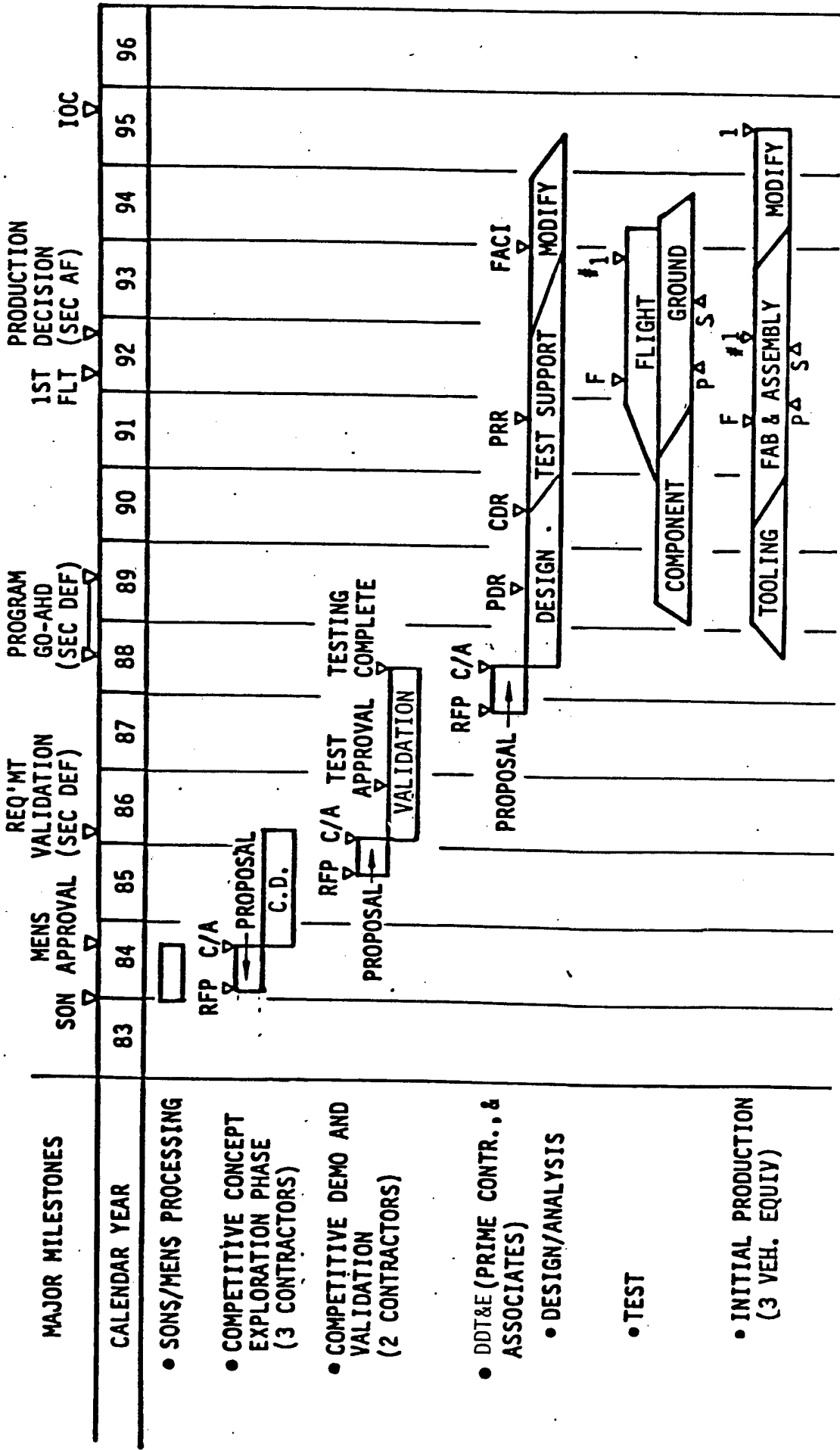



THIS PAGE INTENTIONALLY LEFT BLANK

### **3.1.4 Technology Risk Assessment**

### **3.1.5 Requirements Compliance**

### **3.1.6 Conclusions**

#### TECHNOLOGY ISSUES

Concept B-1 performance is based on an assumed 1995 technology status. The technology issues identified in the adjacent chart represent an assessment of the risk level associated with the assumptions used in the design. A high risk identification implies performance, schedule and cost may be impacted. Medium or low risk rating implies one or two of the above may be affected. The ratings identified are judgmental, but were assigned after reviewing the key design baseline decisions.

The two high risk items, engine turnaround and orbiter structure, are items that may be resolved due to ongoing planned efforts to evaluate these items.

# Technology Issues

ITEM	BOOSTER	ORBITER
MASS FRACTION	CRYOGENIC WET WING PRESSURE MEDIUM RISK	
STRUCTURES/MATERIALS THERMAL MANAGEMENT	ADVANCED COMPOSITES MACH 2.5 TRANSIENT HEATING LOW RISK	CRYOGENIC TO REENTRY TEMP. MAT'L REUSABLE & LIGHTWEIGHT EVACUATED H/C - HIGH RISK
PROPULSION	A/B TECH. AVAILABLE M = 3.0 LOW RISK	ROCKET: <ul style="list-style-type: none"> <li>o CHILL DOWN - MEDIUM RISK</li> <li>o TURNAROUND - HIGH RISK</li> <li>o HORIZONTAL FIRING - LOW RISK</li> <li>o SSME UPGRADE - LOW RISK</li> </ul>
POWER/AERO & LIFE SUP'T		LOW RISK
SEPARATION		SLING SYSTEM - LOW RISK
GN&C/STABILITY & CONT.	LOW RISK	EXTENSIVE FLIGHT SOFTWARE ALL AZ. & LAT. LAUNCH - LOW RISK
LANDING	LOW RISK	REQUIRES AIRFIELD PRIORITY CLEARANCE OPERATIONAL RISK
BASING FACILITIES		OPERATIONAL NOISE - (SONIC BOOM) - LOW RISK LH2 & LOX TANKAGE INSTL. & OPS. - LOW RISK
CONFIGURATION CHANGES		MODIFICATIONS IN REVIEW - SINGLE SSME ORBITER ENGINE <ul style="list-style-type: none"> <li>- EXOTIC A/B BOOSTER</li> <li>- A/B &amp; ROCKET BOOSTER</li> </ul>
PROGRAM COST & SCHEDULE		CONTINUOUS DEVELOPMENT - DRIVEN BY <ul style="list-style-type: none"> <li>o DESIGN DETAIL</li> <li>o REQUIREMENTS</li> </ul>

## TWO-STAGE (B-1 CONCEPT) COMPLIANCE WITH TAV REQUIREMENTS/GOALS

Concept B-1 meets all the requirements stated in Battelle's document D83-02434 (Revised 7/29/83, Secret), "Final Requirements for a Transatmospheric Vehicle Concept Development." In addition, Concept B-1 complies with all the design goals except the desire to have a single stage system. Concept B-1 was proposed to reduce the weight growth technology risk. Historically, airplane weight growth ranges between 10 to 30 percent from concept development to the flight weight version. This growth is attributed to additional requirements as well as engineering optimism in the initial design phases. The two-stage performance is less sensitive to weight growth and therefore provides less inherent risk to the success of an operational system.

# BOEING PROPRIETARY

## Two-Stage (B-1 Concept) Compliance With TAV Requirements/Goals

ITEM	TWO STAGE CAPABILITY
o OPERATION REQUIREMENTS	
(1) MANNED FLIGHT OPERATION	CONFIGURED FOR TWO MAN FLIGHT CREW
(2) GLOBAL RANGE	PROVIDES ALL AZIMUTH LAUNCH TO ORBITAL ALTITUDES
(3) SORTIE OPERATIONS	SYSTEM CAN DO SUBORBITAL "ONCE AROUND" SORTIE MISSIONS
(4) RAPID RESPONSE	SYSTEM CONCEPTUALLY WILL MEET MILITARY AIRPLANE BASE ESCAPE TIMELINES
(5) FLEXIBLE BASING	DESIGN IS COMPATIBLE WITH MILITARY BASE HANDLING AND OPERATIONS
(6) HORIZONTAL T/O AND LANDING	T/O AND RECOVERY USE NORMAL RUNWAYS
(7) ADVERSE WEATHER OPERATION	DESIGNED TO FLY IN ALL WEATHER CONDITIONS
o DESIGN GOALS	
(1) RESPONSE TIME - 5 MINS (FROM ALERT STATUS)	MEETS 5 MIN GOAL (WITH CRYOGENICS LOADED)
(2) TURNAROUND TIME - 2 MISSIONS/DAY	SYSTEM CAN BE TURNED AROUND IN 12 HOURS (PRELIMINARY TIMELINE ESTIMATES)
(3) FULLY REUSABLE	BOOSTER AND ORBITER REUSE ALL COMPONENTS
(4) SINGLE STAGE (GROUND LAUNCHED)	OPERATIONAL FLEXIBILITY AND WEIGHT GROWTH CONCERNS FAVORED A TWO-STAGE CONCEPT
(5) 20,000 LBS TO LOW POLAR ORBIT	SYSTEM MEETS PERFORMANCE GOAL
(6) MULTIPLE ORBIT STAY	CREW PROVISIONS ARE AVAILABLE TO MEET 12 HRS

### CONCLUSIONS

The two-stage fully reusable HTO launch system concept will fulfill the USAF's need for an operational military system used to utilize the advantages of space in future years. The system can be operated from existing bases since its gross weight is only a modest increase from existing airplane systems. The technology growth to date and the technology advances required to make this concept a reality are acceptable development risks. The Boeing studies on the two-stage system have not identified a fatal flaw.

# Conclusions

- CONCEPT B-1 ○ HAS MILITARY OPERATION CAPABILITY
  - WILL BE A FUNCTIONAL WEAPON SYSTEM
  - HAS ACCEPTABLE DEVELOPMENT RISKS
  - MEETS ALL DESIGN REQUIREMENTS
- SYSTEM PAYLOAD-TO-ORBIT PERFORMANCE GOAL ACCOMPLISHED WITH A 1.3M LB GLOW
- CONCEPT ACCOUNTS FOR KEY TECHNOLOGY GROWTH
  - EXISTING AIRBREATHER AND ROCKET ENGINE PLANNED UPGRATING
  - RECOGNIZES BOEING COMMITMENT TO ADVANCED GRAPHITE COMPOSITES DESIGN AND ASSEMBLY
  - ANTICIPATES DEVELOPMENT OF HOT STRUCTURE ASSEMBLY PROCESSES
- CONCEPT USES STATE-OF-THE-ART 1995 SUBSYSTEM WEIGHTS AND VOLUMES (e.g., AVIONICS)



## **3.2 Sortie Vehicle (Concept B-2)**

## 3.2.1 Detailed Concept Definition

The air-launched Sortie TAV (concept B-2) basic assumptions are outlined on the facing page. The baseline configuration is shown in isometric form on the following page.

The Boeing study effort on Air-Launched Sortie Vehicle (ALSV) was initiated under subcontract to Pratt & Whitney as a possible application for using and/or upgrading the RL-10 engine. The study was conducted from November 1981 through August 1982 under Air Force contract to Rocket Propulsion Laboratories and is reported in detail in three documents: AFRPL-TR-82-069, Volume I - Program Summary; Volume II - Technical Report; and Volume III - Appendix.

The data presented in this document drew extensively from the original study. Additional studies were conducted to evaluate the changes required to meet the "TAV Preliminary Requirements," specifically to determine the maximum reasonable payload in polar orbit (5000 pounds) in a manned configuration.

This concept emphasizes the use of existing technology to assure a high degree of creditability in achievement of performance, schedule, and cost estimates quoted.

## AIR LAUNCHED SORTIE TAV (CONCEPT B-2)

The air-launched Sortie TAV (concept B-2) basic assumptions are outlined on the facing page. The baseline configuration is shown in isometric form on the following page.

The Boeing study effort on Air-Launched Sortie Vehicle (ALSV) was initiated under subcontract to Pratt & Whitney as a possible application for using and/or upgrading the RL-10 engine. The study was conducted from November 1981 through August 1982 under Air Force contract to Rocket Propulsion Laboratories and is reported in detail in three documents: AFRPL-TR-82-069, Volume I - Program Summary; Volume II - Technical Report; and Volume III - Appendix.

The data presented in this document drew extensively from the original study. Additional studies were conducted to evaluate the changes required to meet the "TAV Preliminary Requirements," specifically to determine the maximum reasonable payload in polar orbit (5000 pounds) in a manned configuration.

This concept emphasizes the use of existing technology to assure a high degree of creditability in achievement of performance, schedule, and cost estimates quoted.

BOEING PROPRIETARY

## Air Launched Sortie TAV (Concept B-2)

D180-27669-4

193

- BASELINE APPROACH—GO FOR LOW RISK, QUICKEST AND CHEAPEST DEVELOPMENT
  - USE EXISTING ENGINES—SSME AND RL-10'S
    - SEVEN YEARS TO DEVELOP A NEW ENGINE
    - SAVES 0.5 TO 1.0 \$B OF DDT&E COST
  - USE EXISTING SUBSYSTEMS TECHNOLOGY
  - GRAPHITE EPOXY AND GRAPHITE POLYIMIDE STRUCTURE
  - ADVANCED CERAMIC THERMAL PROTECTION
  - STS AND IUS AVIONICS, RCS, EPS, ETC.
  - REQUIRES 747 GROWTH DERIVATIVE (7000 FT<sup>2</sup> WING)
  - NECESSARY TO MEET MANNED 5000 LB PAYLOAD CAPABILITY
  - DESIGN AND TOOLING COSTS COULD BE OFFSET BY FREIGHTER/COMMERCIAL DERIVATIVE PRODUCTION

THE AIR LAUNCHED SORTIE APPROACH TRADES EARLY LOW-COST, LOW RISK DEVELOPMENT AGAINST HIGHER OPERATING COSTS

- KEY QUESTION IS BREAKEVEN FLIGHTS PER VEHICLE

AIR LAUNCHED SORTIE/TAV

The figure shown on the opposite page depicts the launch sequence of the Air Launched Sortie Vehicle and the 747 Carrier Aircraft. All of the cryogenic propellants would be contained in vacuum jacketed tanks inside the carrier aircraft. The drop tank and the cryogenic propellant tanks in the Sortie Vehicle would be empty, but the Sortie Vehicle would have its discretionary mission equipment, storable propellants, and other consumables on board. After takeoff, the combination climbs to approximately 25,000 ft, at which time cooldown and cryogenic propellant transfer to the drop tanks and Sortie Vehicle is started.

Release of the Sortie Vehicle occurs at approximately 25,000 ft and approximately 20-deg flight path angle under approximately -.04-g normal acceleration, which ensures positive separation. The thrust from the two outboard RL10's exceeds the drag of the Sortie Vehicle/drop tank combination at this altitude, so propellants remain settled in the engines and their inlet feedlines. The remaining SSME rocket engine is started as soon as the Sortie Vehicle has cleared the 747's tail. The drop tank is emptied after 277 sec at approximately 305,000 ft and 21,600 ft/s. It is then discarded and burns up on reentry. The Sortie Vehicle achieves orbital velocity using propellants contained in its internal tanks.

The Sortie Vehicle then performs its mission. This will probably be of only one or two orbits, so the losses in cryogenic propellants contained in the vehicle's internal tanks will be minimal. These propellants will be used for the vehicle's deorbit burn and, if desired, could also be used for other propulsive maneuvers. Finally, after completing its mission and deorbit burn, the Sortie Vehicle reenters and lands at an Air Force Base with a 10,000-ft runway. Normally this will probably be the same base at which the 747 launch aircraft had landed.

BOEING PROPRIETARY

# Air Launch Sortie/TAV (Concept B-2)

- SINGLE SSME + PAIR OF STANDARD RL10'S
- INCREASED T/W ELIMINATES NEED FOR ROCKET AUGMENTATION OF 747
- AIR LAUNCH GLOW INCREASED TO 425,000 LBS.
- 5,000 LBS PAYLOAD TO 500,000 FT POLAR ORBIT

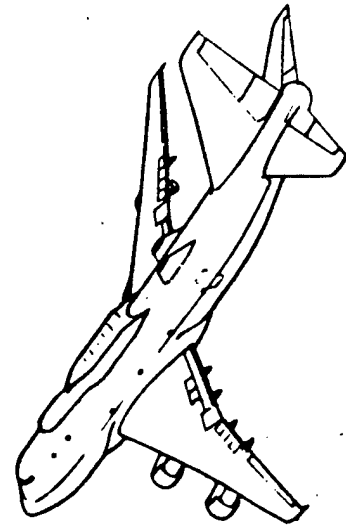
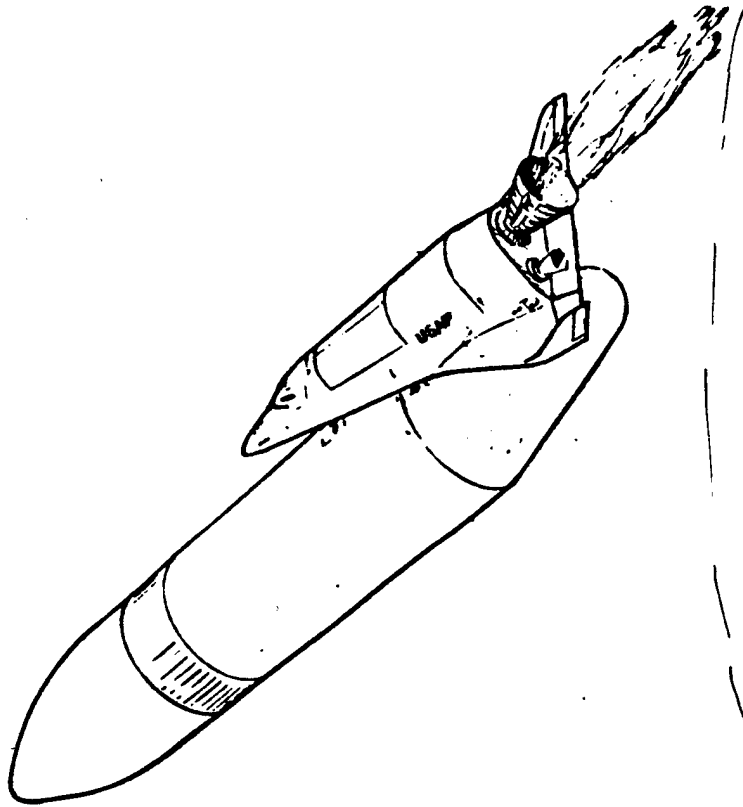

**BOEING PROPRIETARY**

**CONCEPT B-2 ORBITER CONFIGURATION**

The facing figure shows a three-view configuration drawing of the baseline concept. An important factor is that the entry wing loading raises the temperature to the point which precludes metal TPS and forces the use of a ceramic TPS. The landing wing loading is within the same range as the shuttle orbiter, so we would expect approximately the same characteristics. The system as shown is sized for a glow of 425,000 lb.

BOEING PROPRIETARY

# Concept B-2 Orbiter Configuration

CHARACTERISTICS
SW(TRAP) = 940 FT <sup>2</sup>
STF = 67 EACH
W/S ENTRY = 36.7
W/S LANDING = 43.7
GROSS WEIGHT = 59,350
WPROPELLANT = 16,100
SYSTEM GLOW = 425,000 LB

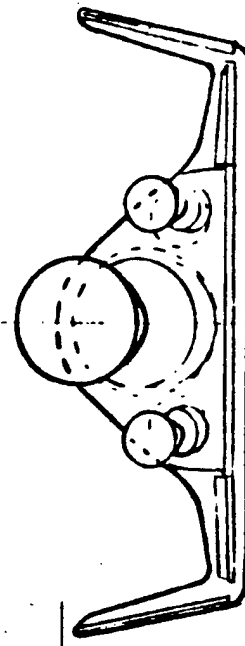
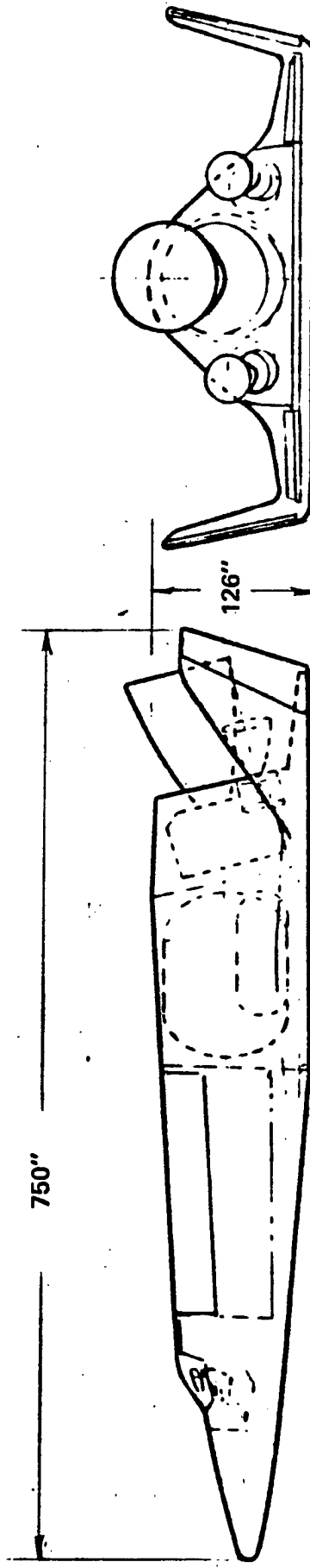
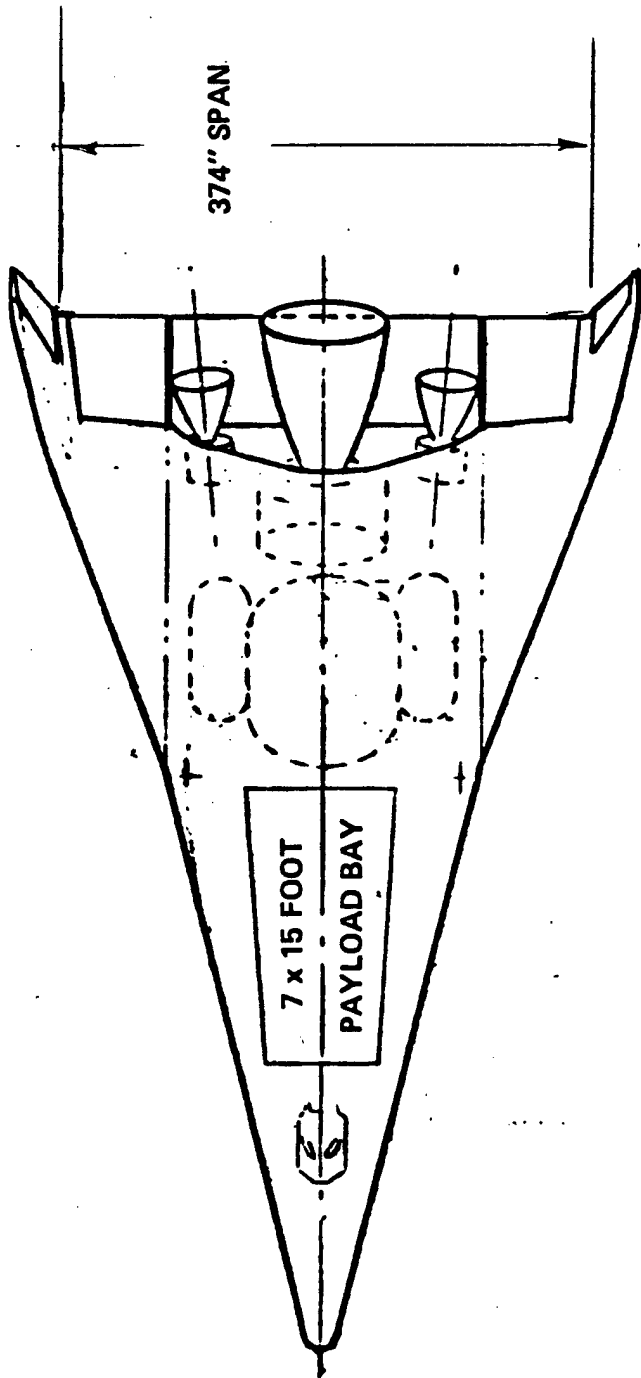



BOEING PROPRIETARY

CONCEPT B-2 CONFIGURATION FEATURES

Key design features for concept B-2 is the once-around polar mission with minimum subsystems; the 7 x 15-ft payload bay with a 5,000 lb payload. The vehicle carries a one-man crew with possibility for a two-man crew, or a second crewman in the payload bay. These requirements are much stricter than the original air-launch Sortie vehicle. As a result, we have added requirements and features to the vehicle equivalent to about 8,000 lb of payload. So, this is equivalent, if we had the original vehicle, of about 13,000 lb of payload. In this concept we are using a standard SSME at 109% thrust level and existing RL10A-3-3A engines which we are using for on-orbit maneuvering. Features of the structure and TPS will be discussed in detail on the following pages.

BOEING PROPRIETARY

## Concept B-2 Configuration Features

### CONFIGURATION FEATURES

- DESIGN REQUIREMENTS
  - ONCE AROUND POLAR (MINIMUM SUBSYSTEMS)
  - 7 x 15 FOOT PAYLOAD BAY (5000 LB AMSC REQ.)
  - ONE MAN CREW (2ND CREWMAN IN P/L BAY)
  - 100 MISSION LIFETIME
- PROPULSION
  - 109% SSME
  - RL10-33A BASELINED FOR ON-ORBIT MANEUVERING
- STRUCTURE
  - COMPOSITE FRAME, STRINGER & PANEL CONSTRUCTION
  - TITANIUM FOR HIGHLY LOADED COMPONENTS
  - INTERNAL H<sub>2</sub> AND O<sub>2</sub> TANKAGE FOR FINAL INSERTION CIRCULARIZATION, ORBIT MANEUVERING AND DE-ORBIT
  - COMPOSITE PAYLOAD BAY DOORS
  - COMPOSITE WING SPARS AND RIBS
- TPS
  - FRCI ON LOWER SURFACES
  - AFRSI/TITANIUM ON UPPER SURFACES
  - ACC NOSECONE AND LEADING EDGES

AIR LAUNCHED SORTIE VEHICLE STRUCTURAL DEFINITION

The structural definition shown is for the Air Launch Sortie Vehicle instead of the stage-and-a-half TAV vehicle, but the structural characteristics are thought to be the same. Heavily loaded components would be titanium, such as the attachment fittings and some of the engine thrust fittings. Much of the internal structure would be graphite epoxy with the external panels being graphite-polyimide composite materials. These external panels are covered with a ceramic thermal protection system, the so-called shuttle tile. The vehicle has a carbon-carbon nosecon and possibly a carbon-carbon body flap. These materials are 1983 state of the art and have been tested or are in existence right now for these applications.

BOEING PROPRIETARY

# Air Launched Sortie Vehicle Structural Definition

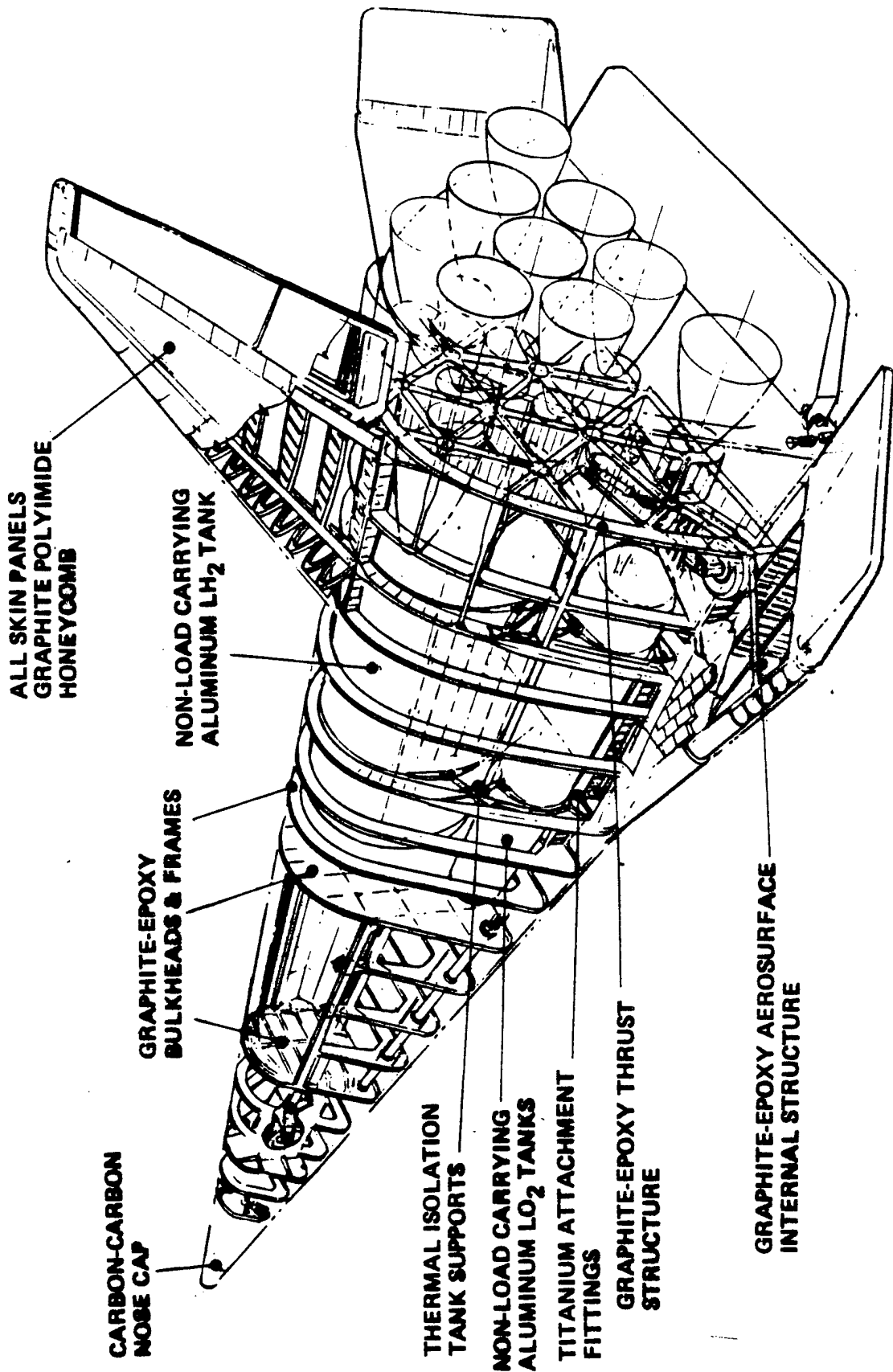

THERMAL PROTECTION SYSTEM

The figure opposite shows the peak temperature distribution on a vehicle with planform loading of 35-lb/ft<sup>2</sup>, which is typical of the Sortie operating range. The thermal-protection-system distribution is also shown. It consists of a carbon-carbon nosecap while the leading edge and body flap material will be a high-density fibrous refractory material somewhere in the order of 20 to 22 lb/ft<sup>3</sup>. The major part of the bottom of the vehicle is covered with a low-density fibrous refractory material, the so-called shuttle tile, at approximately 9 to 10 lb/ft<sup>3</sup>. The temperature distributions shown are well within the capability of this material and provides a large margin, several hundred degrees, of overshoot capability. This margin ensures safe operation in unknown atmospheres and under wartime conditions.

BOEING PROPRIETARY

# Thermal Protection System

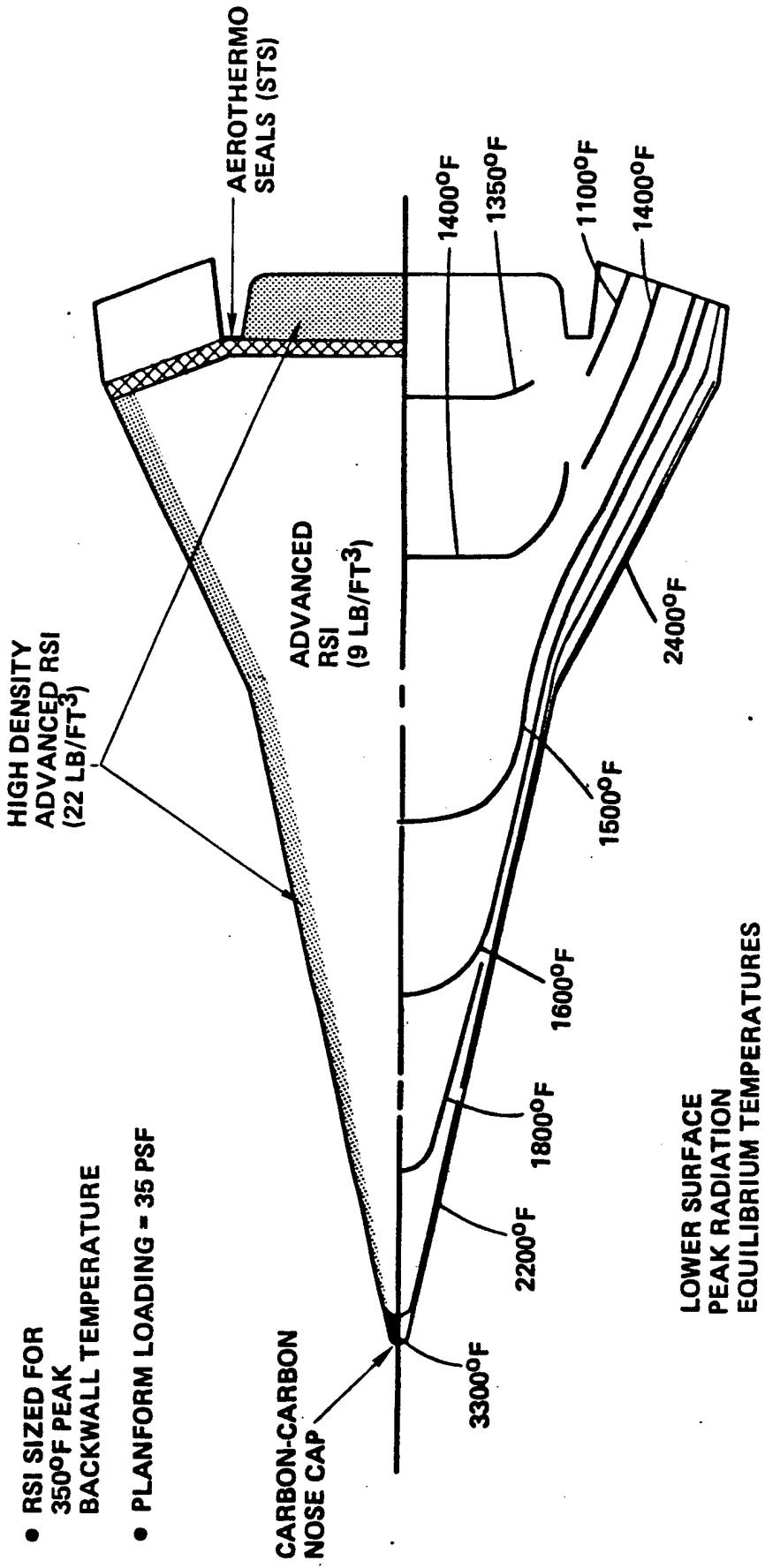

- RSI SIZED FOR 3500°F PEAK BACKWALL TEMPERATURE
- PLANFORM LOADING = 35 PSF

CARBON-CARBON NOSE CAP

ADVANCED RSI (9 LB/FT<sup>3</sup>)

HIGH DENSITY ADVANCED RSI (22 LB/FT<sup>3</sup>)

AEROTHERMO SEALS (STS)

LOWER SURFACE PEAK RADIATION EQUILIBRIUM TEMPERATURES

1400°F  
1350°F  
1100°F  
1400°F

2400°F  
1500°F

1600°F  
1800°F  
2200°F

3300°F

CONCEPT B-2, CONFIGURATION FEATURES (continued)

The avionics for this configuration are state of the art such as found in the current shuttle orbiter or the inertial upper stage system. The communications would be a Ku band with a TDRSS link to allow the vehicle to talk to controllers anywhere on the earth continuously. Considerable use of television is thought, rather than large optical windows, to both reduce weight and give the crew enhanced visual capability. A full set of navigation aids is considered for instrument landings.

CONFIGURATION FEATURES (CONT'D)

- AVIONICS
  - COMPUTERS—CPUs AND IOPS MEMORY MODULES MDMs
  - REMOTE SWITCHING TO REDUCE WIRING TO/FROM COCKPIT
- COMMUNICATIONS
  - Ku BAND DOWNLINK
- TDRSS LINK
- TELEVISION
  - CREW CAB, P/L BAY, FWD GEAR WELL, COCKPIT
- NAVIGATION AIDS
  - IMU'S
  - TACAN 140,000 FT—MSBLS
  - MSBLS 18,000 FT 12—13 NMI RANGE FROM TOUCHDOWN
  - AIR DATA SYSTEM BELOW M.3
  - RADAR ALTIMETER
- GUIDANCE NAV & CONTROL
  - MANUAL, AUTO FLIGHT CONTROL
  - IMU'S & NAV. INITIALIZED @ LAUNCH WRT PAD POSITION
  - RATE GYROS AND ACCELEROMETER ASSEMBLIES ON ORBITER
  - CLOSED LOOP GUIDANCE TO MECO TARGET



**CONCEPT B-2, ORBITER CHARACTERISTICS AND GROUP WEIGHT STATEMENT**

The weight breakdown for the baseline orbiter concept is shown on the opposite page. The empty weight of the vehicle, dry weight, is 34,600 lb and the full-up weight, including propellant, will be just under 60,000 lb.

BOEING PROPRIETARY  
**Concept B-2**

# Orbiter Characteristics & Group Weight Statement

<u>AREA (FT<sup>2</sup>)</u>	<u>WEIGHT (LB)</u>
BODY PLANFORM--INCL FLAP	814
BODY FLAP	114
EXPOSED WING PLANFORM--INCL ELEVONS	194
ELEVONS	64
TIP FINS PLANFORM	62
VEHICLE PLANFORM	1070
TIP FIN--INCL RUDDER } PER TIP	73
RUDDER	24
BODY WETTED AREA--EXCL FLAP	1770
BODY BASE AREA--ABOVE FLAP	140
<u>PLANFORM LOADING (PSF)</u>	
ENTRY--NO PAYLOAD	33.0
ENTRY--WITH 5000 LB PAYLOAD	37.7
<u>XCG (% LENGTH TO FLAP HINGE LINE)</u>	
ENTRY/LANDING--NO PAYLOAD	TBD
ENTRY/LANDING--WITH 5,000 LB P/L	TBD
AEROSURFACES--INCL BODY FLAP	1,710
BODY--INCL MAIN TANKS	9,940
INDUCED ENVIRONMENTAL PROTECTION	3,860
PROPULSION--ASCENT/OMS	10,600
PROPULSION--RCS	440
SYSTEMS { PRIME POWER, ELECTRICAL, SURFACE CONTROLS, AVIONICS, ECS, PERSONNEL PROVISIONS, PAYLOAD PROVISIONS	4,400
LANDING AND AUXILIARY SYSTEMS	1,220
WEIGHT MARGIN (10% EXCL ROCKET ENGINES)	2,430
(DRY WEIGHT)	(34,600)
PERSONNEL (1)	240
PAYLOAD (ROUND TRIP)	5,000
RESIDUALS & RESERVES @ LANDING	190
INFLIGHT LOSSES	2,780
OMS PROPELLANT--NOMINAL	-----
RCS PROPELLANT--NOMINAL	440
ASCENT PROPELLANT--INCL FPR	16,100
(GROSS WEIGHT @ SEPARATION)	(59,350)
	$\lambda = 0.296$

INERT WEIGHT = 59,350 - 16,100 - 5,000 = 38,250

**BOEING PROPRIETARY****BASELINE CONCEPT B-2 ORBITER**

The facing figure shows the characteristics of the baseline orbiter vehicle. The structure is graphite epoxy or graphite polyimide composite. This is covered with an advanced ceramic thermal protection system. Key features of the thermal protection system are: carbon carbon at the nose, a high-density tile material on the leading edges, a lower density fibrous refractory material on the underside, and a flexible thermal protection system which covers the top. The vehicle is nominally shown with one crew member, although the cockpit has been sized to take two crew members; has a 7 x 15-ft payload bay; carries approximately 16,100 lb of internal L<sub>2</sub>/LH<sub>2</sub> propellant in a mixture ratio of 6:1. As shown, it has wing tip fin controllers, carbon carbon body flap, and is designed with a single standard SSME and two orbital maneuvering system engines which would be RL10A-3-3A's.

BOEING PROPRIETARY  
**Baseline Concept B-2 Orbiter**

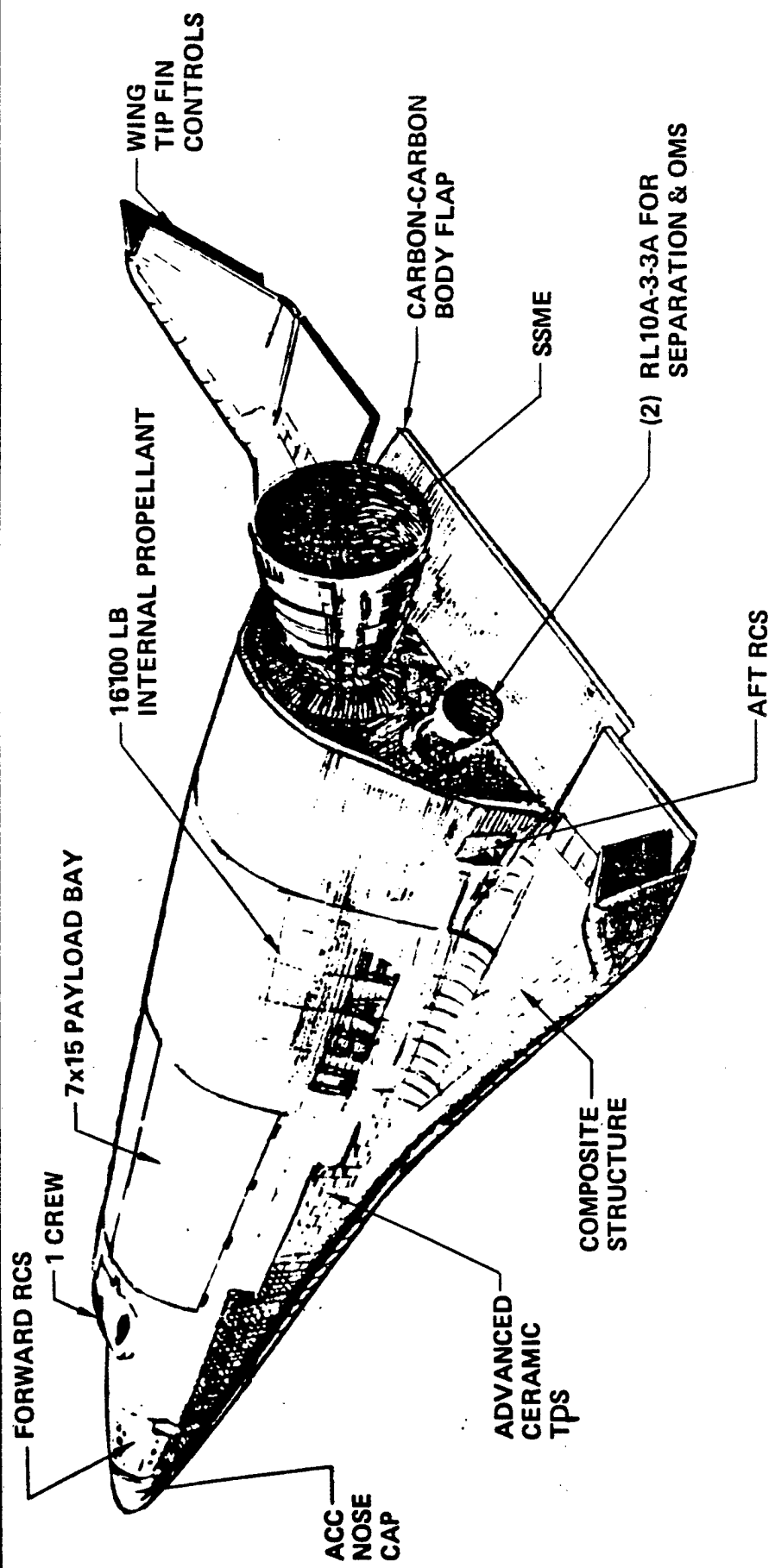

BASELINE B-2 CONCEPT USES  
EXISTING TECHNOLOGY THROUGHOUT

BOEING PROPRIETARY

CONCEPT B-2, CONFIGURATION FEATURES (continued)

The RCS baseline is a shuttle-type bipropellant system because it is in existence today. There would be certain advantages to going with a L02/propane or L02/RP1 thruster if it were available because it provides for increased safety. This would ease the turnaround time by not requiring as much time to safe the system during turnaround. Electromechanical actuators were chosen primarily for their servicing capability. No weight advantage is seen over hydraulic system but there is a definite advantage in turnaround time. Since it is an all-electrical system, the vehicle uses electrical power instead of an APU. A lightweight battery system and fuel cells would be used if extended orbits are required. The thermal control system is relatively simple, as shown. Because the vehicle will generally have a limited time on orbit, the environment control system will also be simple.

BOEING PROPRIETARY  
**Concept B-2**

D180-27669-4  
211

CONFIGURATION FEATURES (CONT'D)

ATTITUDE CONTROL

- BIPROPELLANT ACS BASELINED

ACTUATORS

- ELECTRO-MECHANICAL ACTUATORS EXCEPT FOR PRESSURE ACCUMULATOR HYDRAULIC BRAKE ACTUATION AND HYDRAULIC PUMP TAKEOFF FOR SSME GIMBAL

- FREE FALL GEAR DEPLOYMENT, ELECTRICALLY RELEASED

ELECTRICAL POWER

- BATTERY POWER SUPPLY

THERMAL CONTROL

- ACCOMPLISHED BY GSE UNTIL LAUNCH, THERMAL SOAK TO 140,000 FT, THEN WATER SPRAY BOILER-FREON LOOP FOR FLIGHT ABOVE 140,000 FT. REENTRY BELOW 140,000 FT AMMONIA BOILER-FREON LOOP. H<sub>2</sub>O COOLANT LOOP FOR COCKPIT

ENVIRONMENTAL CONTROL

- REDUNDANT N<sub>2</sub> BOTTLES WITH CRYO-O<sub>2</sub> SUPPLY WITH EMERGENCY O<sub>2</sub> BACKUP BOTTLE
- FAN AIR/H<sub>2</sub>O SEPARATORS

BOEING PROPRIETARY

DROP TANK DESIGN REQUIREMENTS

It is very important that the drop tank have a high  $\lambda'$ . The concept shown on the next page has a  $\lambda'$  approaching .94. To do this it requires a common bulkhead tank and very little thermal insulation. Thermal insulation is limited just to keep oxygen or air from freezing on the tank when it reaches altitude. The tank is chilled with boiloff gas but not filled with propellant until it gets to altitude. At altitude it is well above the frost line, so there shouldn't be any water freezing on the tank. The feed and fill lines are sized to fill the tank in 20 minutes and also the feed lines are sized by the fact the engine pumps need a certain head to operate. Important design requirements on the drop tank are slosh, especially when it is partly filled; thermal stresses, since the tank is filled very quickly; and the fact that the tank should burn up on reentry if possible.

BOEING PROPRIETARY

## Drop Tank Design Requirements

---

- $\lambda \geq .935$ , COMMON BULKHEAD CONFIGURATION
- LO<sub>2</sub> FORWARD FOR TRIMABLE LAUNCH CG
- LOX TANK STRUCTURE DESIGNED BY 2.0 G NORMAL LOAD FACTOR FULLY FUELED
- DISTRIBUTED LOAD OR CRADLE INTERFACE WITH CARRIER
- LH<sub>2</sub> TANK STRUCTURE DESIGNED BY COMBINATION OF HYDROSTATIC AND AXIAL LOADS DURING BOOST
- TANK TPS (CPR FOAM) SIZED BY COMBINATION OF ASCENT HEATING (LOX OGIVE) AND BOILOFF (LH<sub>2</sub> TANK)
- FILL AND FEED LINES SIZED BY HIGH SPEED FILL REQUIREMENT (20 MINUTES) AND ENGINE NPSH REQUIREMENTS
- SLOSH/C.G. CONTROL DURING PROPELLANT TRANSFER
- DROP TANK FRAME THERMAL STRESSES
- RE-ENTRY BURNUP



BOEING PROPRIETARY

D180-27669-4  
214

DROP TANK CONFIGURATION

The drop tank configuration shown on the opposite page is an all-aluminum drop tank of skin and stringer construction designed to carry 344,450 lb of LO<sub>2</sub>/LH<sub>2</sub> propellant at a 6:1 mixture ratio. Configuration of the drop tank is similar to that shown in the earlier air launch Sortie vehicle study and has just been sized up to meet the larger propellant requirements for this study.

BOEING PROPRIETARY

# Drop Tank Configuration

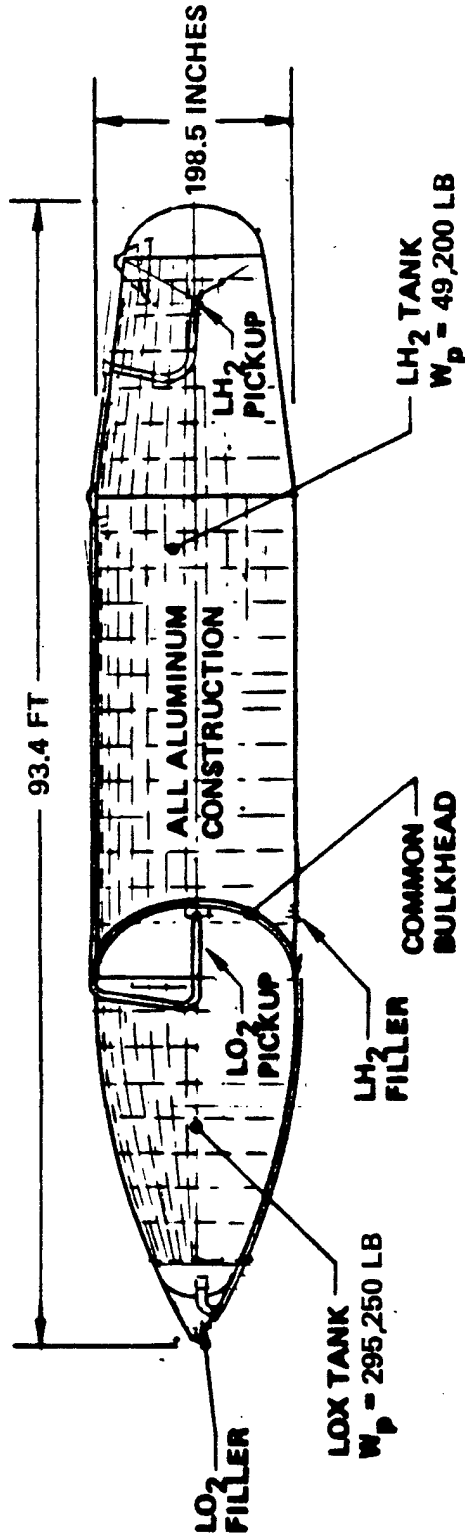

STRUCTURES WEIGHT	12,690 LB	USABLE PROPELLANT = 344,450 LB
TPS WEIGHT	930	GROSS WEIGHT = 365,650 LB
PROPULSION/MECHANICAL	2,680	MASS FRACTION, $\lambda' = 0.942$
ELECTRICAL/INSTRUMENTATION	200	
ATTACHMENT/SEPARATION	600	
RANGE SAFETY	200	
10% GROWTH	1,730	
(DRY WEIGHT)	(19,030 LB)	
RESIDUALS	2,170	
(INERT WEIGHT)	(21,200 LB)	

BOEING PROPRIETARY

#### 747 GROWTH DERIVATIVE LAUNCH PLATFORM

The airplane configuration shown is one of several possible growth derivatives of the existing 747-200 freighter airplane. The particular configuration shown is a 7,000-ft<sup>2</sup> aspect ratio 9 wing. This vehicle was originally sized as a possible commercial derivative. As such it had insufficient material in the wing root to withstand the larger bending stresses we will require. As a part of a study the additional material was added to that design which allows us to get up to a max zero fuel weight of 944,200 lb. This allows us to carry on the centerline almost 500,000 lb, 425,000 of which would be payload the other would be equipment in the form of dewars, launch personnel, equipment, etc. The configuration shown has a V tail, that's an option to the conventional tail. The idea for the V tail being this would allow us to use orbiter thrust to obtain a higher flight path angle and altitude before we separated.

BOEING PROPRIETARY

# 747 Growth Derivative Launch Platform

D180-27669-4  
217

## AIRPLANE CHARACTERISTICS

WING AREA = 7000 FT<sup>2</sup>  
ASPECT RATIO = 9.06  
TAKEOFF GROSS WT = 1,144,200 LB  
MAX ZERO FUEL WT = 944,200 LB  
MAX LANDING WT = 1,004,200 LB  
OPERATING EMPTY WT = 506,620 LB  
MAX LAUNCH WT = 425,000 LB  
A/P MISSION FUEL = 200,000 LB

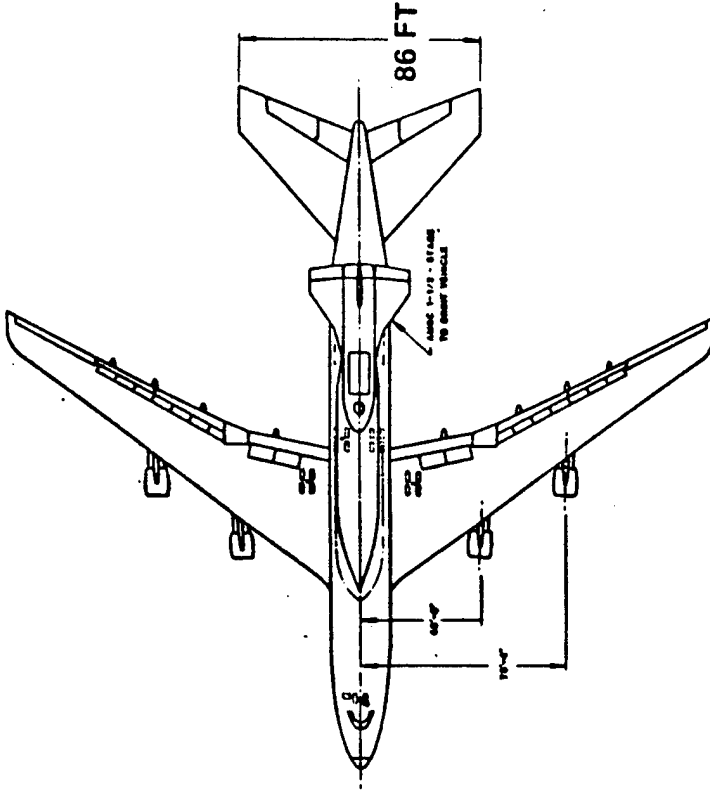

(2) LO<sub>2</sub> TANKS

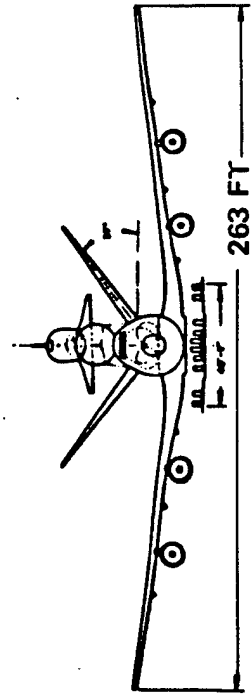
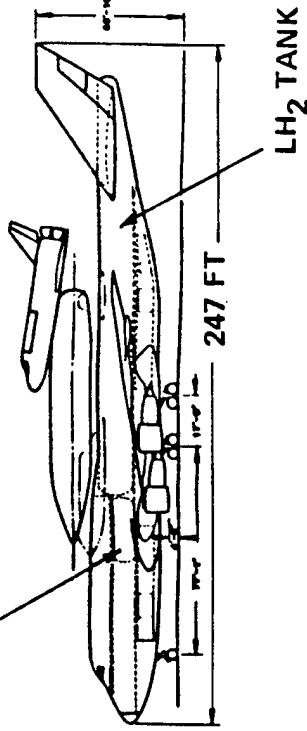

WORLD AIRFIELD DISTRIBUTION

The figure on the opposite page depicts operating sites available for our 747 derivative study airplane. There are over 850 of these sites worldwide with a good portion located in the continental U.S.

BOEING PROPRIETARY

# World Airfield Distribution

## 747 Launcher Aircraft Contingency Operations

8000 Ft. Runway Length

147 Ft. (45 m) Width, LCN 67 (100 Sorties)

851 Airfields

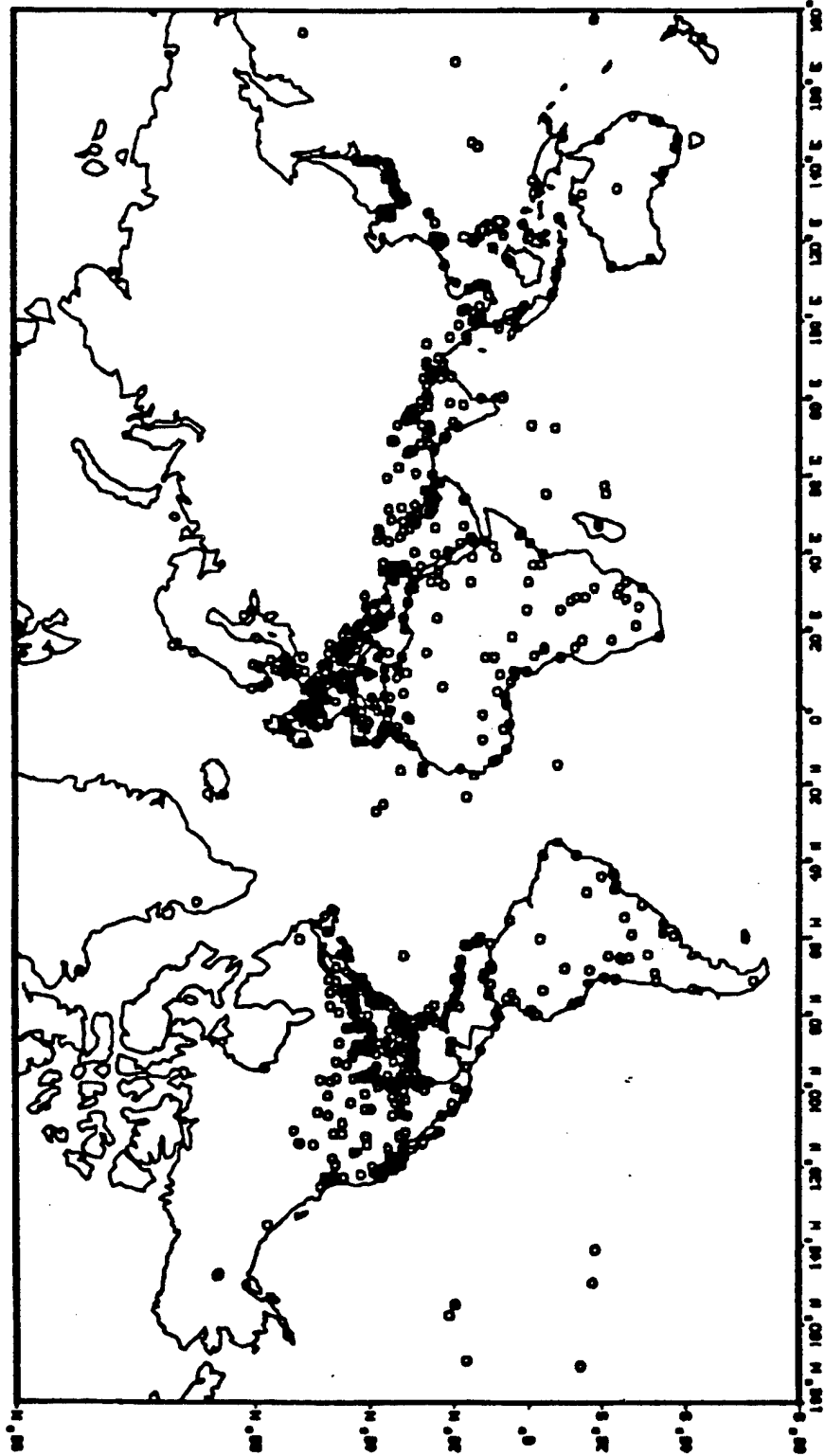

## BOEING PROPRIETARY

## WEIGHT COMPARISONS FOR 747 LAUNCH PLATFORMS AND DERIVATIVES

The chart shown on the opposite page compares the 747 launch aircraft with versions of several derivatives. This table shows the characteristics of the existing modified 747-200 airplane which was used in the Air Launch Sortie Vehicle Study. The center column shows the modified 7,000-ft<sup>2</sup> study airplane as modified for our carrier's launch platform operation. The third column shows a commercial version of this same airplane. The principal difference is in the max zero fuel weight which is increased by over 300,000 lb for the launch airplane by increasing the gauges in the wing center sections. Gauges were increased right up to the limit of the current construction process in what we might expect out of current technology jig.

# Weight Comparisons for 747 Launch Platform and Derivatives

	1982 ALSV STUDY (2.25g OPERATION)	7000 FT <sup>2</sup> WING <sup>②</sup> LAUNCH PLATFORM (2.25G OPERATION)	7000 FT <sup>2</sup> WING <sup>③</sup> COMMERCIAL FREIGHTER (2.5g OPERATONI)
OEW	383,865	506,620	370,600
PAYLOAD	316,135	427,580	259,400
FUEL	160,000	200,000	370,400
TOGW	860,000	1,134,200	1,000,000

MZFW

700,000<sup>①</sup>

944,200

630,000

FUEL CAPACITY, LBS 348,465

513,500

513,500

① THIS IS WITH REDUCED TOGW OF 860,000 LBS  
MTOW IS 890,000 LBS AT MZFW OF 654,000 LBS

② 60,000 LB SLST JT9D-7R4 DERIVATIVE ENGINES

③ 54,750 LB SLST JT9D-7R4G2 ENGINES. NOSE AND SIDE CARGO DOORS



## AIR LAUNCH SORTIE SYSTEM BASING SCENARIO

The scenario for handling and operating the airlaunch sortie system is shown on the opposite figure. The processing and integration facility is a two-level facility where the drop tanks will be mated with the orbiter which will then mated on top of the 747. This will require construction of some new hangar capability, but will allow us to stockpile orbiters and drop tanks with a fully integrated payload so as we go from one payload to another for different operations. Also shown is an alert pad with a cryogenic tankage where these vehicles can stand out and be on a 5-min alert basis.

**BOEING PROPRIETARY**  
**Air Launch Sortie System**  
**Basing Scenario**

- MAJOR FACILITIZATION REQUIRED TO MEET OPERATIONAL GOALS.

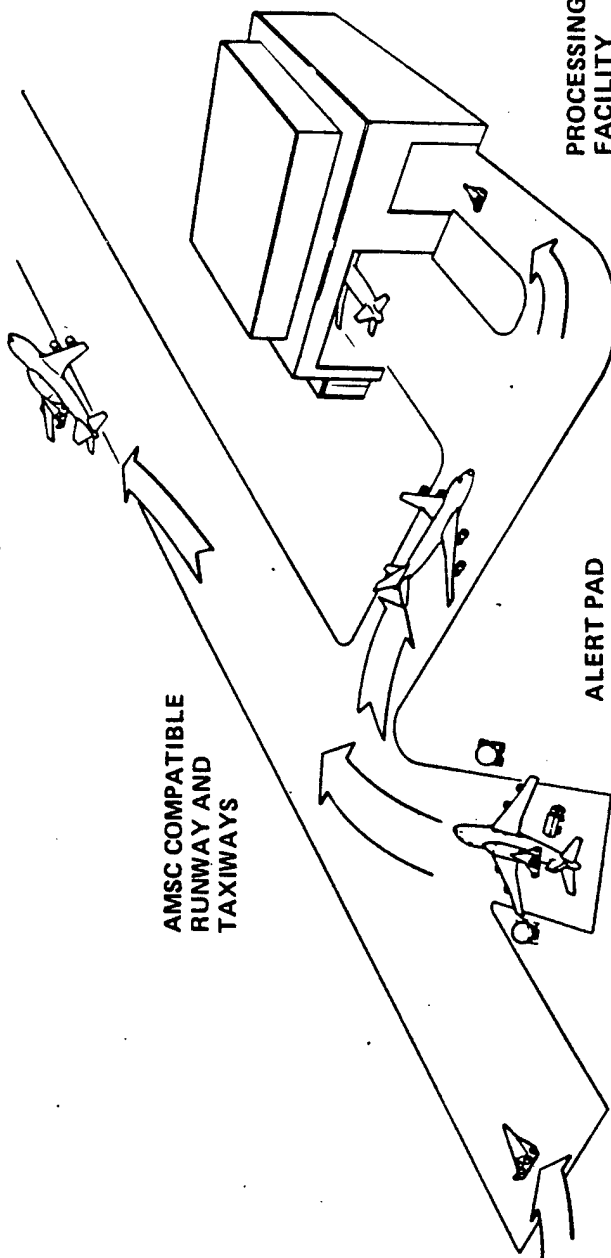

AMSC COMPATIBLE  
 RUNWAY AND  
 TAXIWAYS

- ALERT PAD
- CRYOGENIC FUELING
  - GROUND HOLD EQUIPMENT

PROCESSING AND INTEGRATION  
 FACILITY

- MAINTENANCE
- ORBITER AND AIRCRAFT INTEGRATION
- DROP TANK STORAGE AND CHECKOUT
- SYSTEM CHECKOUT AND LAUNCH PROCESSING
- PAYLOAD INSTALLATION AND CHECKOUT
- MULTIPLE INTEGRATION/ CHECKOUT CELLS

## TAV CONCEPT B-2 TURNAROUND TIME IMPLICATIONS

The chart shown is from the current shuttle operations and shows the time required for turnaround for shuttle orbiter. As you see this time is out at approximately 900 hr, much of which is required of integrating the payload. This implies it is going to be very difficult to get one or two-day turnaround capability with any other reusable spacecraft vehicle. The features required to get this fast turnaround are noted. You need a completely integrated launch preparation facility dedicated to this type of vehicle when you design the orbiter with maximum access so we can do more than one operation simultaneously on the vehicle. Such operations as changing out the RCS system, or changing out a failed component, or reconfiguring the payload bay all have to be done simultaneously. We need the entire work station on an elevator so we can integrate the drop tank with the vehicle at the same time we are integrating the vehicle with the payload. It is very important that the drop tank be prechecked and carrier vehicle preloaded and ready to go before we try to integrate the entire system.

# BOEING PROPRIETARY

## TAV Concept B-2 Turnaround Time Implications

### CURRENT STATE-OF-THE-ART (STS)

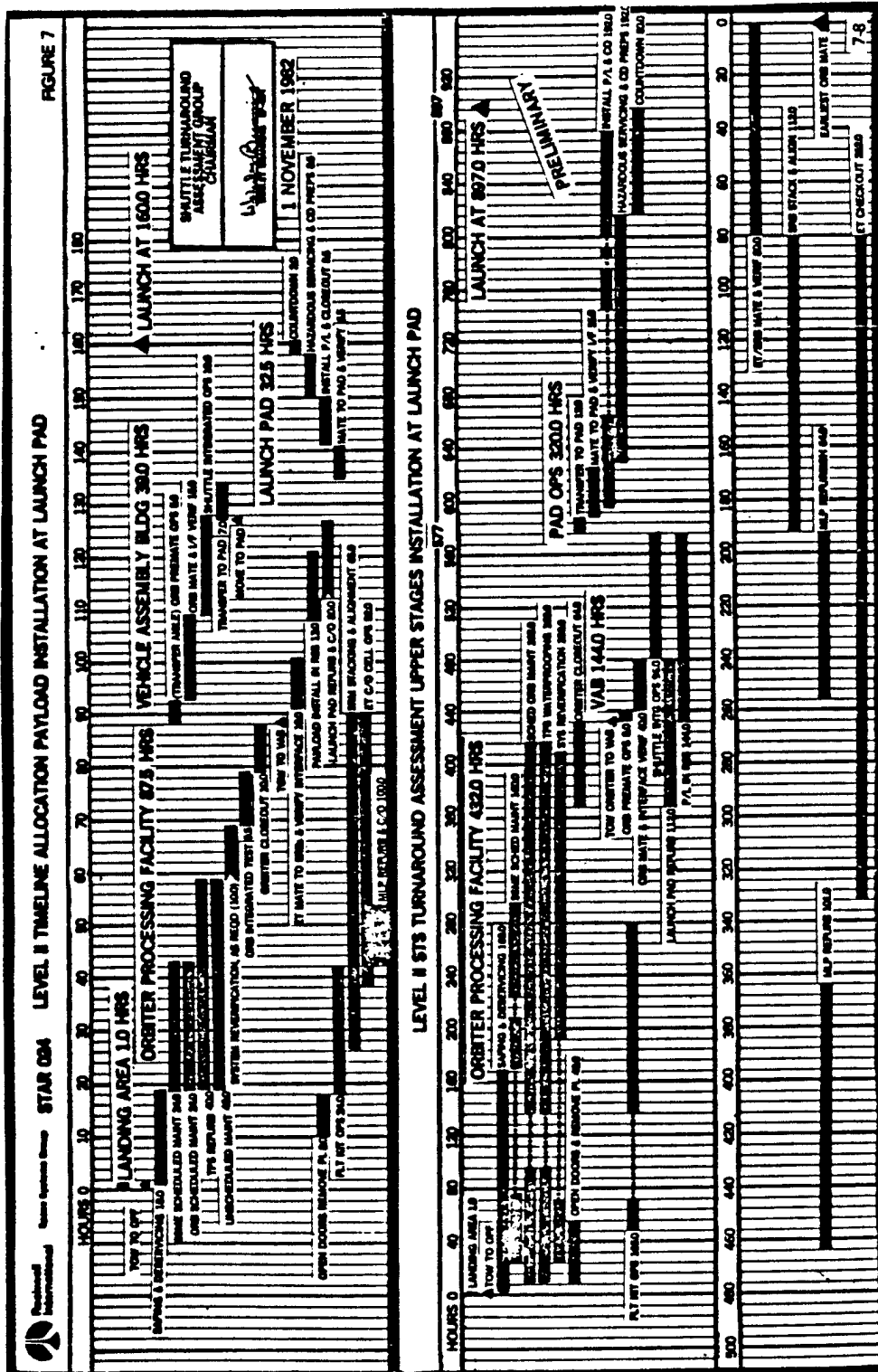

- APPROACHES FOR 1-2 DAY TURNAROUND**

  - INTEGRATED LAUNCH PREPARATION FACILITY
  - MAXIMUM ORBITER ACCESS (MAXIMIZE VEHICLE MANLOADING)
  - ELEVATOR WORK STATION
  - PRE-CHECKED, PRE-POSITIONED DROP TANK
  - SIMULTANEOUS INTERFACING AND CHECKOUT
  - ELIMINATION OF HAZARDOUS MATERIALS

## AIR LAUNCH SORTIE SYSTEM ALERT PAD CONCEPT

The alert pad concept shown allows the simultaneous fueling and recycling of the boilloff on the carrier vehicle, as well as allowing the loading of the crew into the orbiter. The loading concept also allows access to ground power and everything is mobile such that we can clear the alert pad and allow the vehicle to meet its 5-minute alert capability.

BOEING PROPRIETARY  
**Air Launch Sortie System**  
**Alert Pad Concept**

- ALLOWS SYSTEM TO BE MAINTAINED IN FUELED, CHECKED OUT CONDITION READY FOR TAKEOFF.
- CRYO PROPELLANTS STORED IN LAUNCH AIRCRAFT

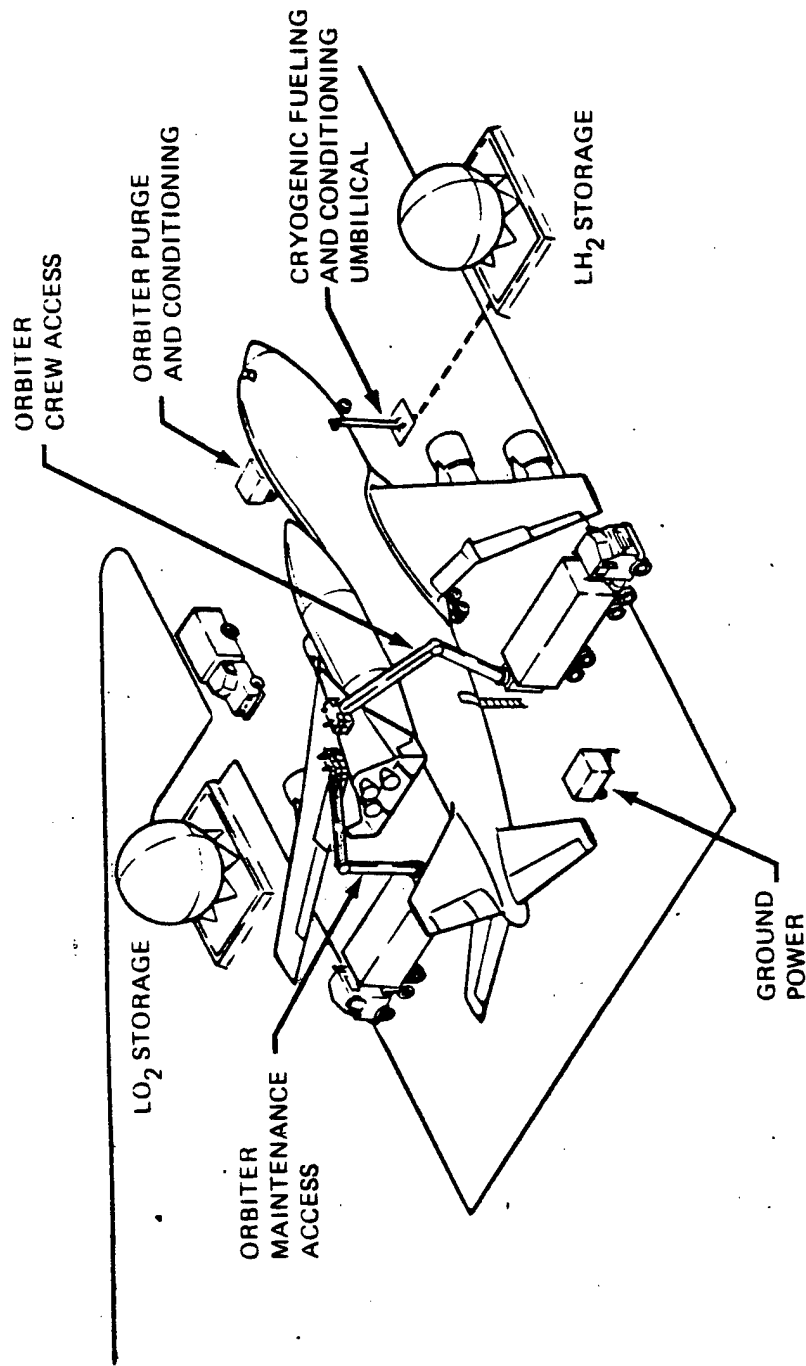

**MISSION CAPABILITY**

The concept B-2 TAV system was designed for 5,000 lb into a 500,000-ft polar orbit. This gave it a capability of about 8,000 lb into a 28.5-deg 160-mi orbit, same as the shuttle, and allows us actually to get over 2,000 lb into a 250-mi circular orbit, allowing some capability up to a projected space station.

BOEING PROPRIETARY  
**Mission Capability**

**Concept B-2**

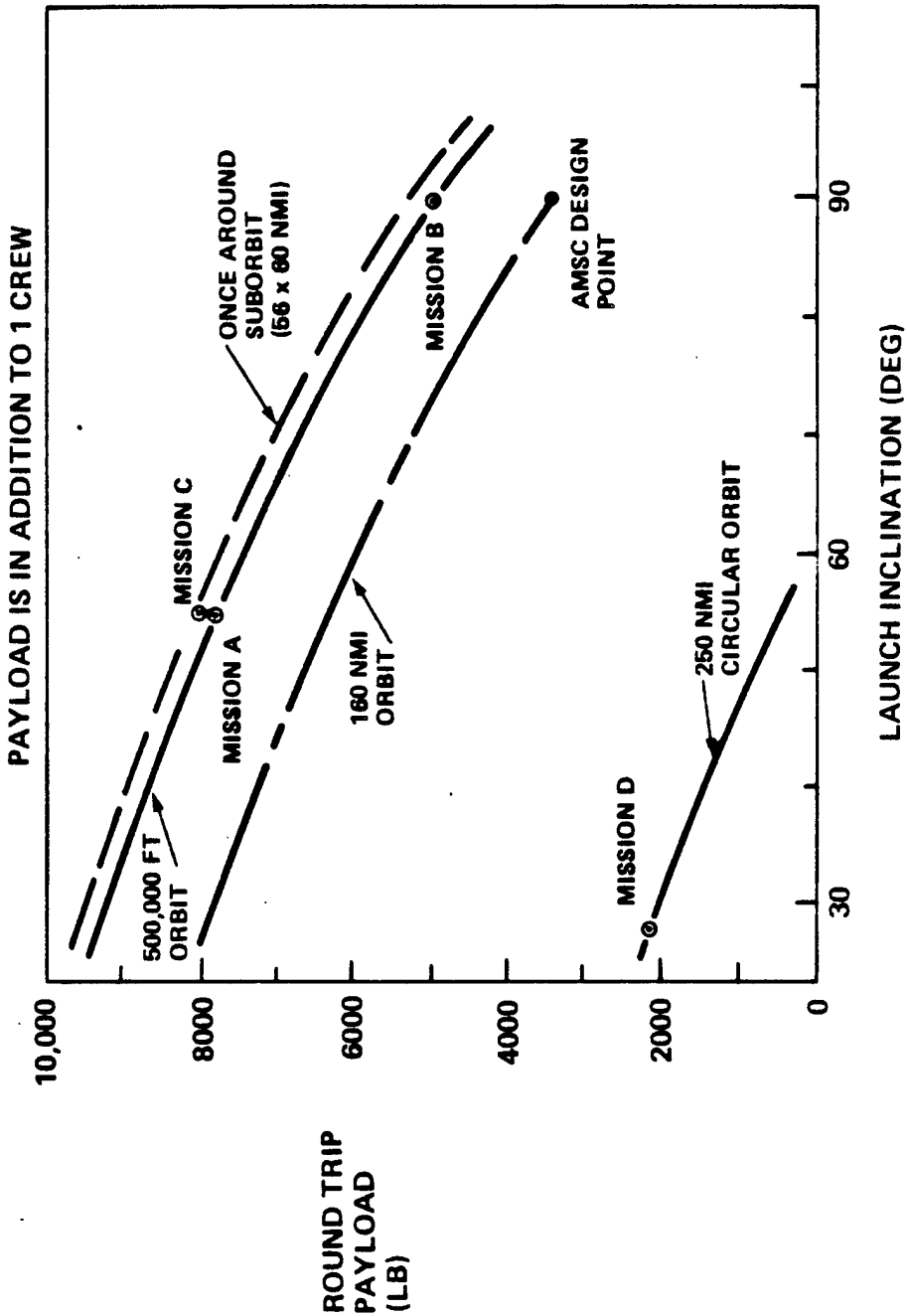



THIS PAGE INTENTIONALLY LEFT BLANK

### **3.2.2 Concept Analysis and Trade Studies**

BOEING PROPRIETARY

IMPACT OF INITIAL THRUST TO WEIGHT AND LAUNCH VELOCITY ON  $\Delta V$  IDEAL

The data shown on the opposite page shows the variation in ideal velocity to orbit as a function of the launch velocity and the initial thrust to weight of the orbiter vehicle. These data show a definite advantage in staging at the higher velocities and shows a definite advantage to thrust to weight greater than 1. Thrust to weights less than 1 required significantly increased ideal velocity to reach the low earth orbit. Interestingly enough the increases in thrust to weight beyond 1, even thrust to weights as high as 2, don't result in significantly improved performance.

# BOEING PROPRIETARY

## Impact of Initial T/W and Launch Velocity on $\Delta V_{Ideal}$

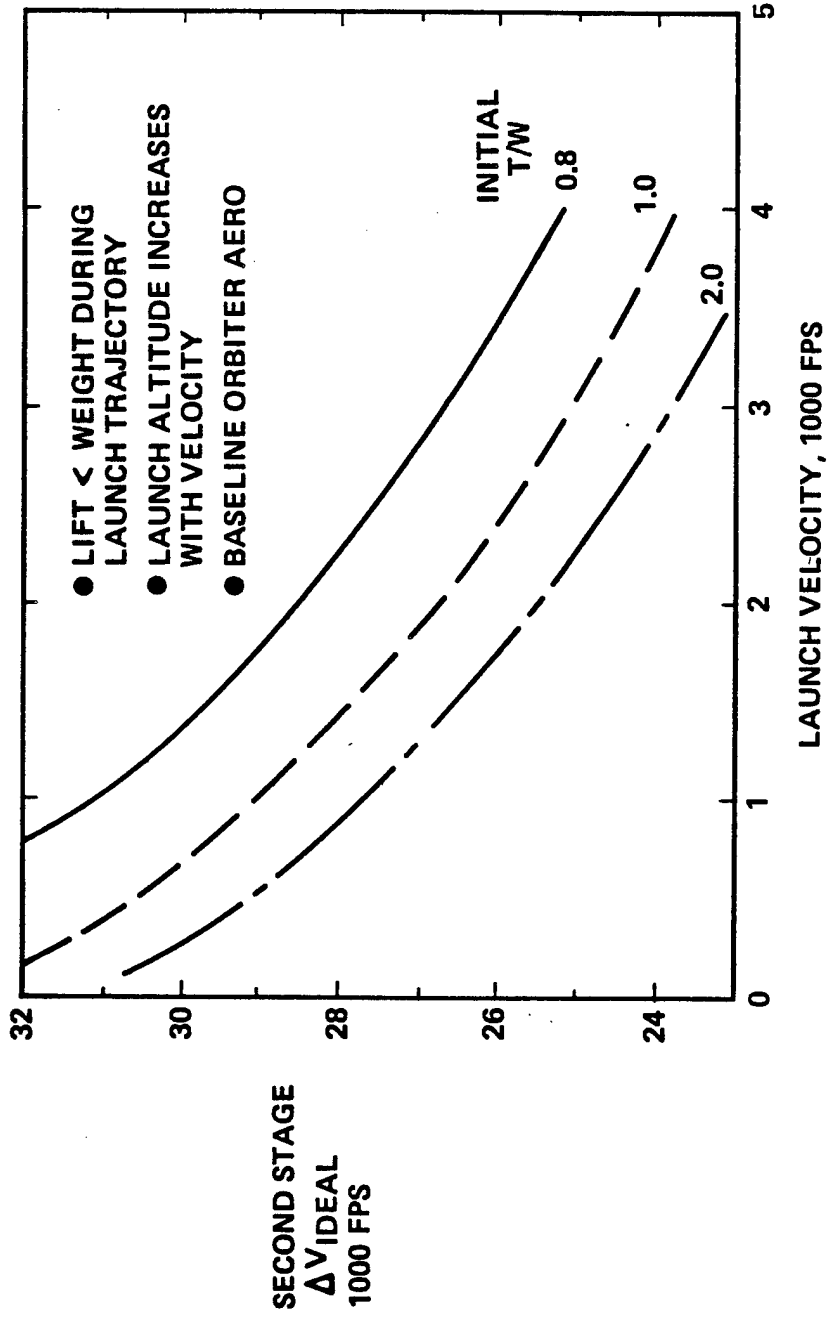

● INITIAL T/W > 1.0 RESULTS IN SEVERE PERFORMANCE PENALTIES

BOEING PROPRIETARY

ORBITER WEIGHT TRENDING

The figure shows a parametric curve of inert weight as a function of onboard propellant. For two different types of vehicle, Trend line A is for a vehicle size for two crew and a 10 x 25-ft payload bay. Trend line B is for a vehicle the size for a single crewman and only a 7 x 15-ft payload bay. There is a no-man's land in the middle where the curve should cross over.

BOEING PROPRIETARY  
**Orbiter Weight Trending**

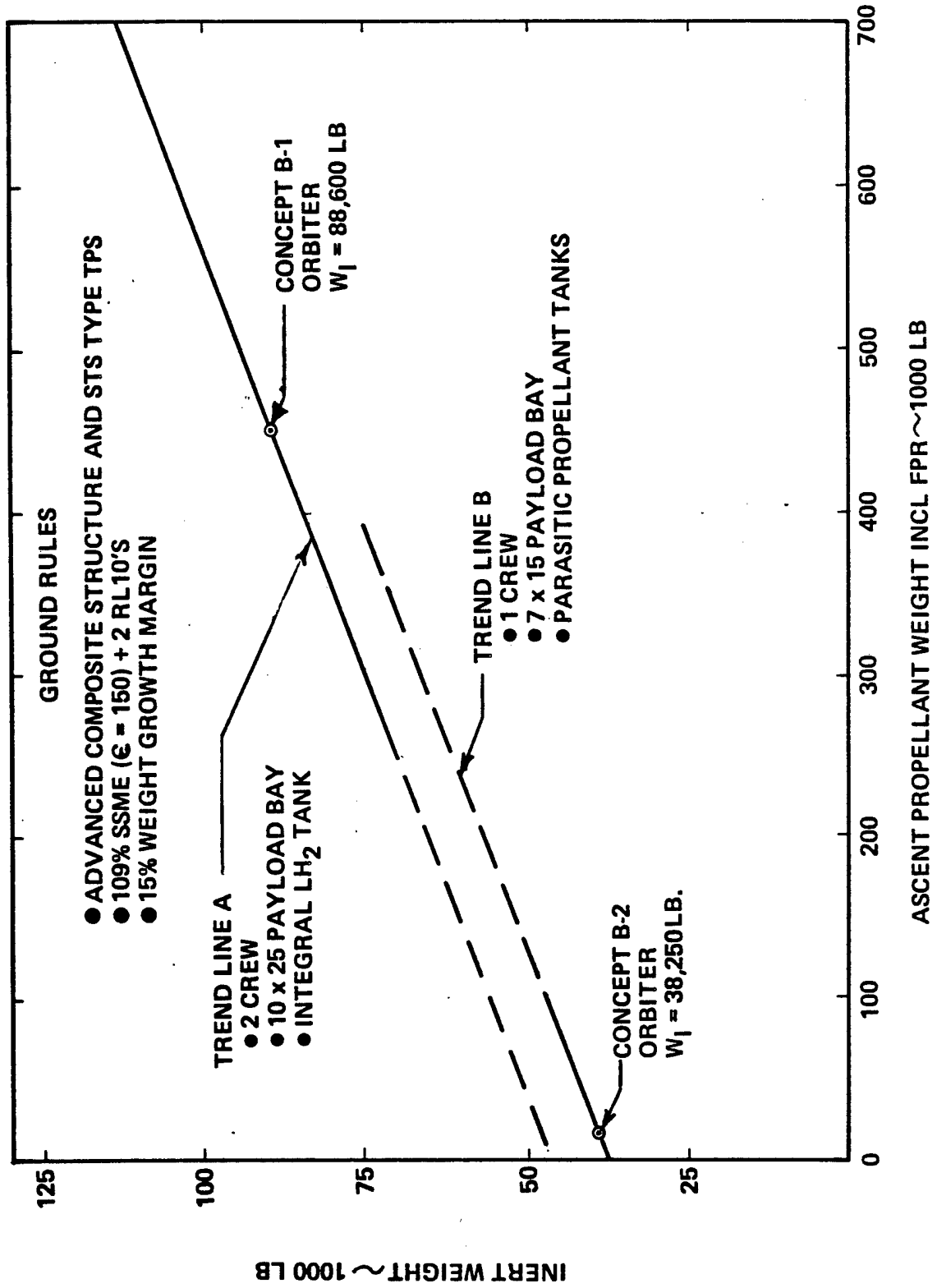

DROP TANK WEIGHT TRENDING

The figure shows the trend line for inert weight in the drop tank as a function of the onboard propellant. It is bounded on the upper side by the lightweight ET, external tank, which carries 1,583,500 lb L02/LH2 propellant and weighs 77,000 lb empty and on the lower side by the drop tank from our original Air Launch Sortie Vehicle contract which carries about 216,300 lb of propellant and weighs about 15,200 lb. This is almost a linear relationship.

The inert weight value for these tanks include:

- Structures Weight
- TPS Weight
- Propulsion/Mechanical
- Electrical/Instrumentation
- Range Safety
- 10% Growth
- Residuals

# BOEING PROPRIETARY Drop Tank Weight Trending

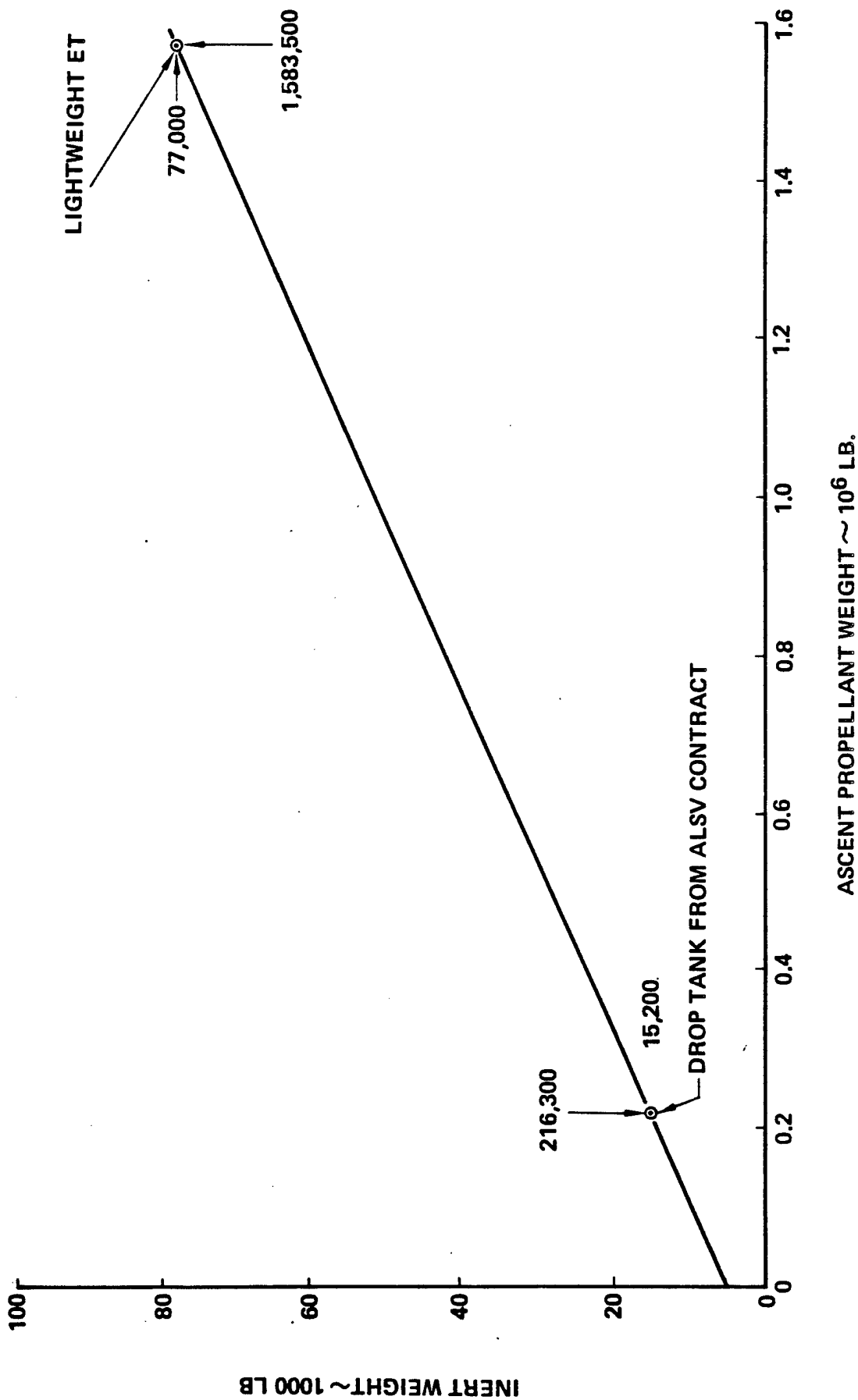



**BOEING PROPRIETARY****VEHICLE PERFORMANCE IMPROVEMENTS WITH NEW ENGINES**

This chart depicts the potential payload performance improvements with a new high thrust-to-weight rocket engine. Plotted here is the weight at burnout weight minus the engine weight for various advanced thrust-to-weight engines. The optimum vehicle thrust to weight lies in a range between 1.25 and 1.3. Points to be noted are the increase in payload performance due to improving the engine thrust to weight from 80 to 120 with no change in Isp. Not shown, but employed from other data, is the fact that increased expansion ratio would provide additional gains, especially for the OMS engines. In fact, data generated, but again not shown, show that raising the Isp to about 470 sec for the main engines and 480 sec for the OMS engines would provide a payload capability up to about 9000 lb for a 500,000-ft polar orbit.

BOEING PROPRIETARY

# Vehicle Performance Improvements with New Engines

- NEW HIGHER T/W ENGINES SIZED FOR HIGHER VEHICLE INITIAL T/W PROVIDE A COUPLE THOUSAND POUNDS OF ADDITIONAL PAYLOAD WITH NO CHANGE IN  $I_{SP}$
- INCREASED EXPANSION RATIO CAN PROVIDE ADDITIONAL PERFORMANCE GAINS ESPECIALLY FOR THE OMS ENGINES.
- NEW MAIN ENGINES WITH  $I_{SP} = 470$  AND OMS ENGINES WITH  $I_{SP} = 480$  WOULD PROVIDE PAYLOAD CAPABILITIES (500,000 FT POLAR) OF 9000 LB.

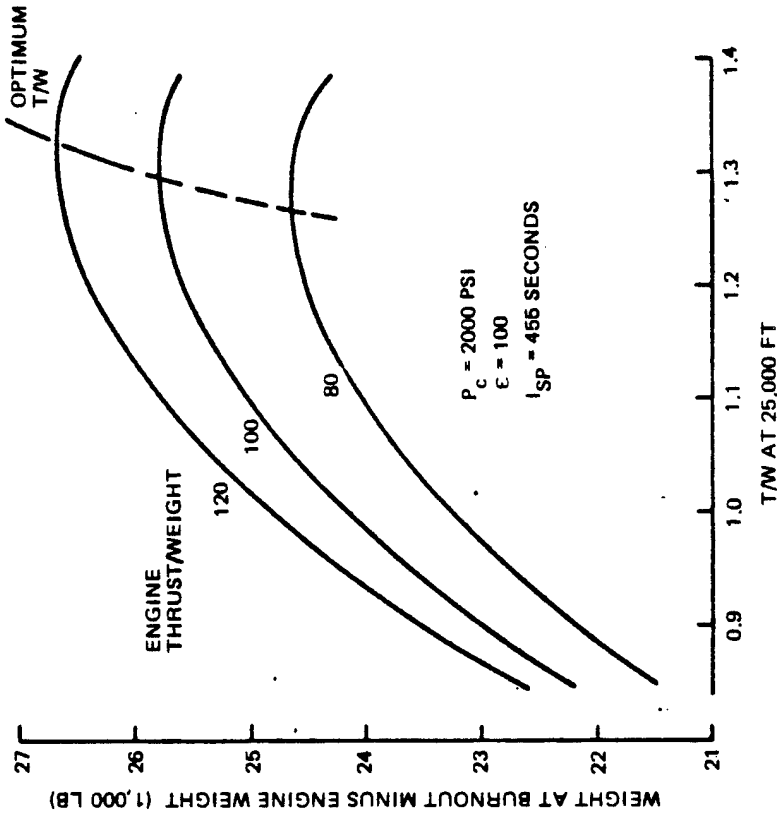

VEHICLE T/W DESIGN CHART (320,000 LB GLOW)

## BOEING PROPRIETARY

## INTACT ABORT DESIGN CHART

This chart is used to show how the vehicle designed with an initial thrust to weight in the regime of up to 1.3 actually has the capability of making a once-around abort. Number 1 shows that design point picked, which is the thrust to weight such that we have a given design performance into a 160-nmi polar orbit. The delta between 1 and 2 shows the additional  $\Delta V$  available if one does not go to 160-nmi orbit but instead tries for a once-around abort and uses the onboard reserves and maneuvering propellant. This amounts to almost 1000 ft/s. If the vehicle goes for once-around instead of a 160-nmi orbit, it could actually do the once-around with a mission initial thrust to weight of about 1. So what one would do then is select a vehicle such that it had a thrust to weight with all engines operating of about 1.33 or 1.35, and then, with one engine out, had a thrust to weight of just over 1. This would allow the vehicle to have an automatic once-around abort capability even if an engine was lost at launch.

# Intact Abort Design Chart

$\Delta V$  REQUIRED FOR 56 x 100 NMI POLAR ORBIT AS A FUNCTION OF INITIAL T/W

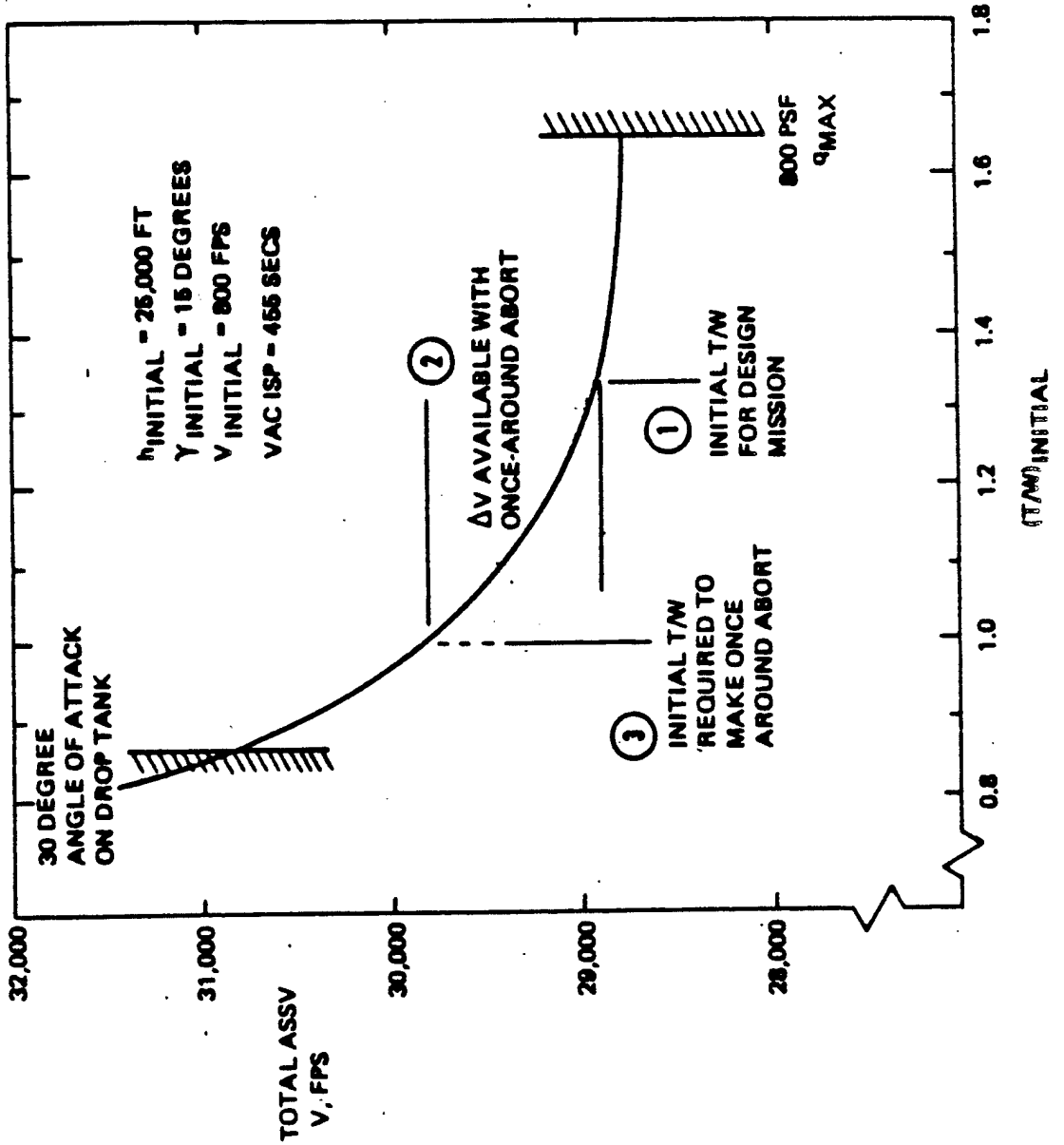

THIS PAGE INTENTIONALLY LEFT BLANK

### **3.2.3 Cost Analysis**

**BOEING PROPRIETARY**

**TOTAL VEHICLE INVESTMENT COSTS AS A FUNCTION OF  
NUMBERS OF VEHICLES IN THE FLEET BY THE YEAR 2000.**

- Carrier investment costs are plotted against the number of TAV (orbiter) vehicles in the fleet assuming a constant 20% ratio (1 747 carrier/booster for each 5 sortie system orbiters). Production tooling for the 747 carrier modification is included.
- TAV investment costs include tooling and manufacture of 50 orbiters at a continuous production rate of 1 sortie vehicle/month.
- Total hardware/investment costs are the sum of TAV costs plus the applicable quantity of 747 carrier/boosters, assuming a constant 20% ratio.

BOEING PROPRIETARY

# Total Vehicle Investment Costs as a Function of Number of Vehicles in Fleet by the Year 2000

SPACE SORTIE SYSTEM (CONCEPT B-2)

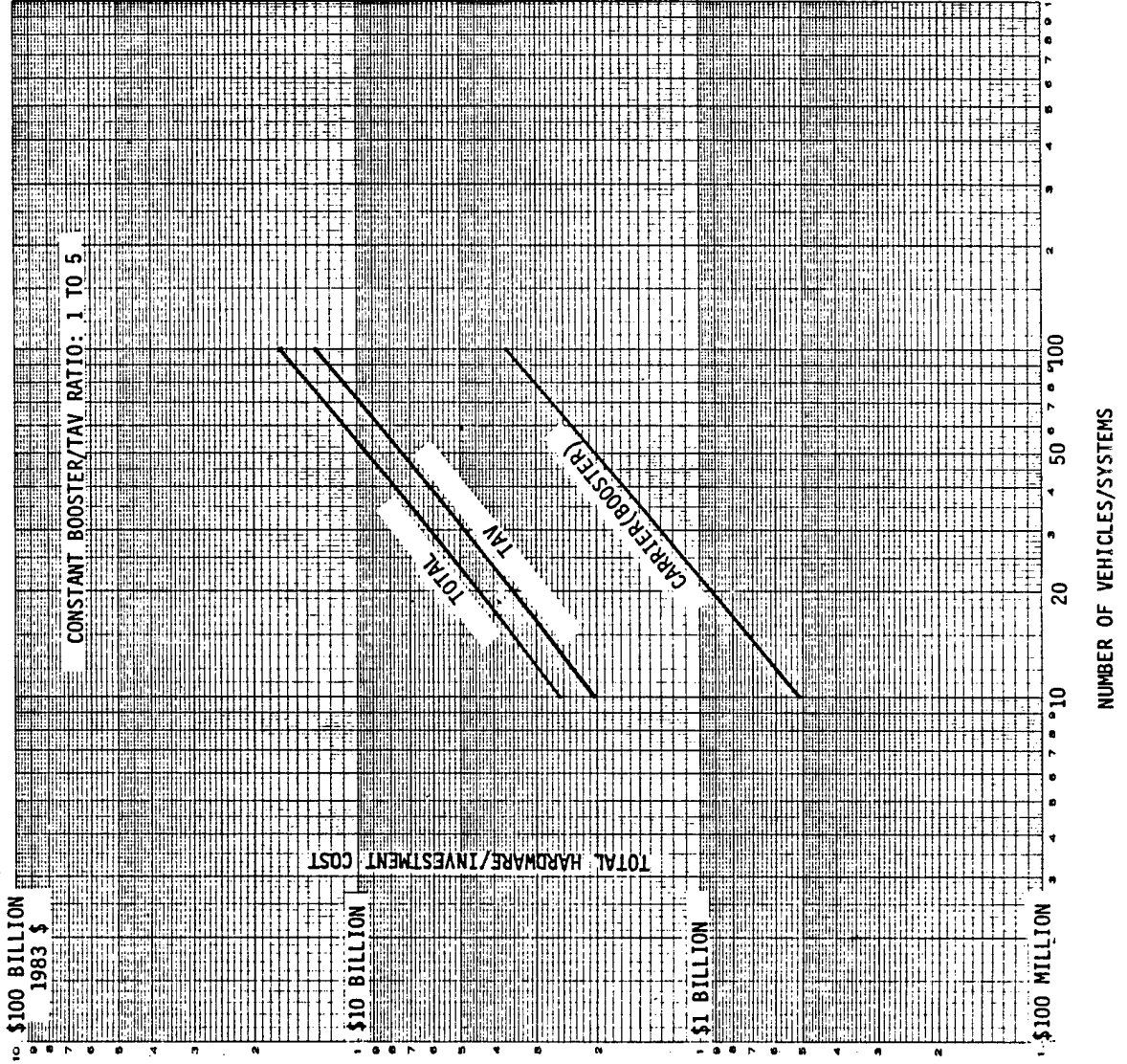



**BOEING PROPRIETARY**

**TOTAL FACILITY INVESTMENT COSTS AS A FUNCTION OF  
NUMBERS OF VEHICLES IN THE FLEET BY THE YEAR 2000**

- Drop tank facilities include production tooling and semiautomated manufacturing plant.
- Ground-support equipment and TAV facilities are primarily in support of the Sortie orbiter vehicles.
- 747 carrier vehicles make use of existing Air Force facilities and ground-support equipment.
- Total facilities are plotted against the number of Sortie orbiter vehicles, assuming sequential activation of ten SAC bases. (One base activation for each 5 orbiters for the first 50 systems with additional vehicles then deployed on the 10 activated bases.)

BOEING PROPRIETARY

# Total Facility Investment Costs as a Function of Number of Vehicles in Fleet by the Year 2000

SPACE SORTIE SYSTEM (CONCEPT B-2)

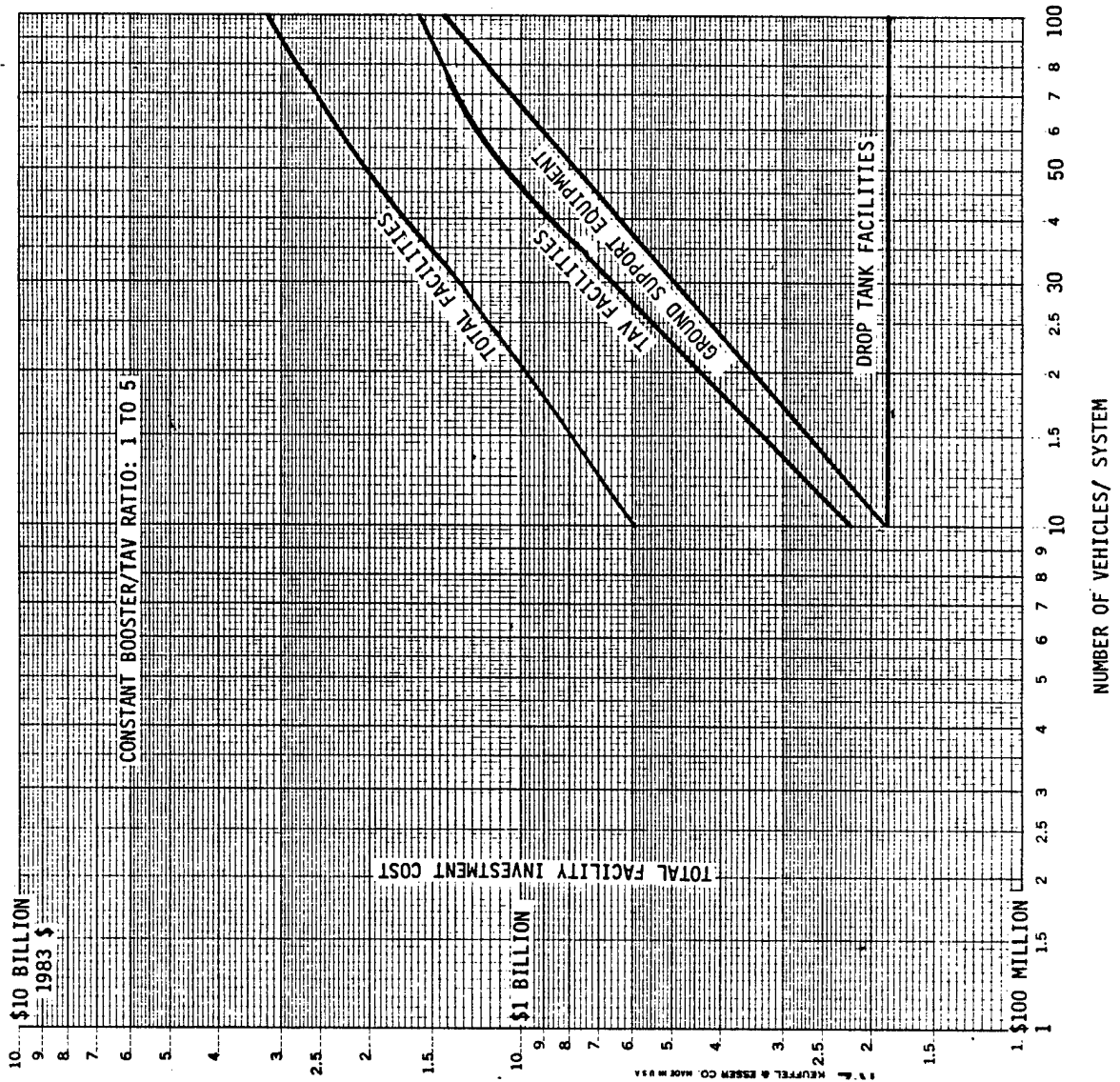

**BOEING PROPRIETARY**

TAV OPERATIONAL COSTS AS A FUNCTION OF  
NUMBER OF VEHICLES AND NUMBER OF FLIGHTS

- Operational costs of propellant and drop tanks were based on "per flight" consumption and varied proportionately with number of flights.
- Other operational costs (personnel, maintenance, spares, and other) were varied with both number of vehicles and utilization (number of flights per vehicle per year).
- Other assumptions were as follows:
  - a. Sequential activation of 10 bases (5 vehicles per base) for first 50 systems produced.
  - b. Twenty-year operational cost of \$2.37 billion per base for baseline scenario (10 bases, 50 orbiters, 100 flights/yr).
  - c. Variances in operational cost due to utilization were based on following assumed factors (applied to baseline).

	Cost Element		
	Personnel	Propulsion	Spares/ Maintenance
1 flt/veh/yr	.88	.50	.65
2 flt/veh/yr	Baseline	Baseline	Baseline
5 flt/veh/yr	1.80	2.50	2.00
10 flt/veh/yr	3.50	5.00	3.80
15 flt/veh/yr	4.90	7.50	5.32
20 flt/veh/yr	6.13	10.00	6.65
			Baseline
			2.20
			4.00
			5.20
			6.00

- Conservative personnel and maintenance costs based on analogy to space shuttle cost per flight.

**BOEING PROPRIETARY**  
**TAV Operational Costs as a Function of**  
**Number of Vehicles and Number of Flights**  
**SPACE SORTIE SYSTEM (CONCEPT B-2)**

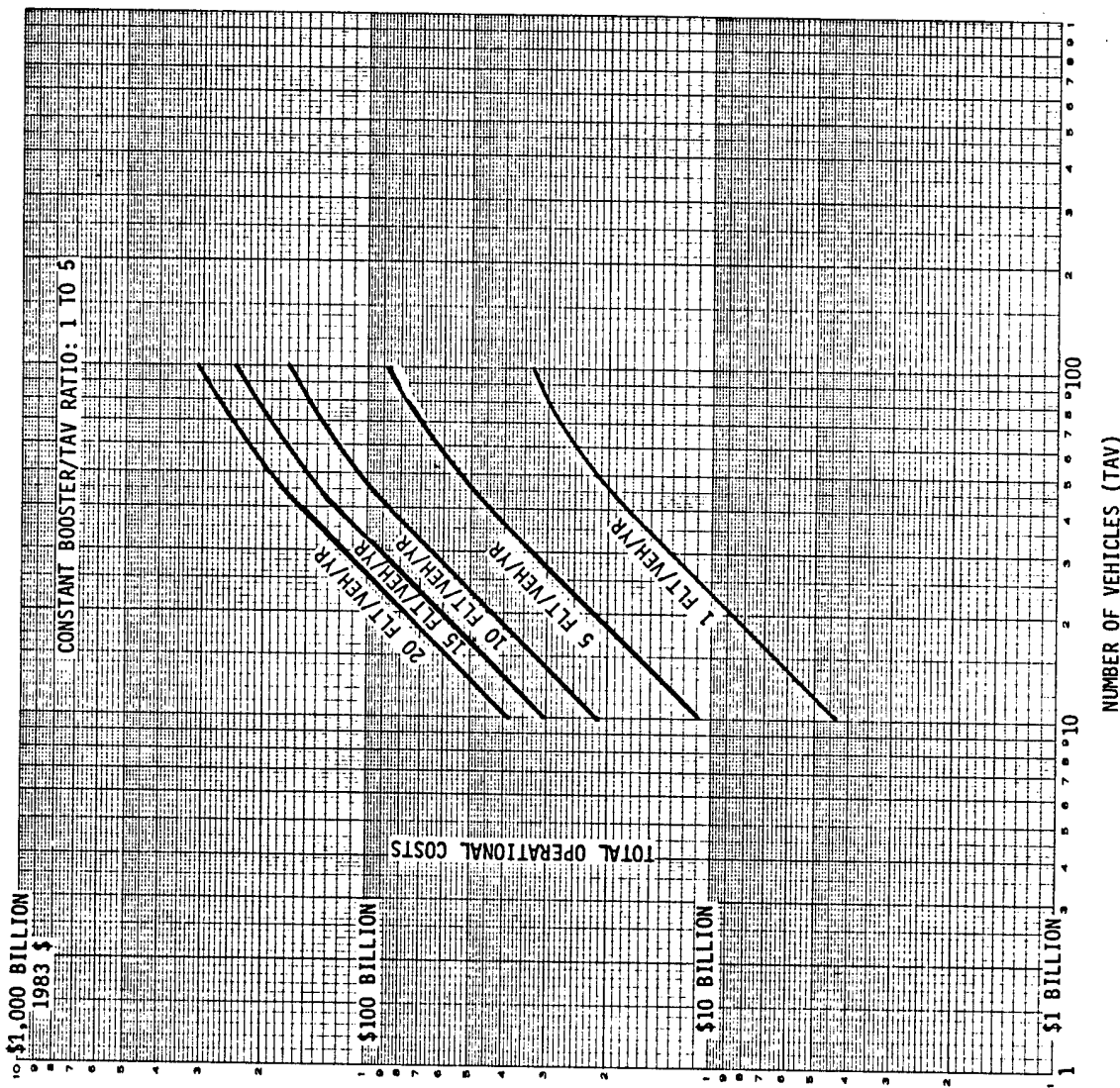

HARDWARE/FACILITY COST FOR DROP TANKS

- Costs shown are based on estimated tooling and facility costs of \$185 million.
- Number one unit cost of tank is estimated at \$14 million.
- Cost/quantity calculations assume an 80% learning curve.

BOEING PROPRIETARY

# Hardware/Facility Cost For Drop Tanks

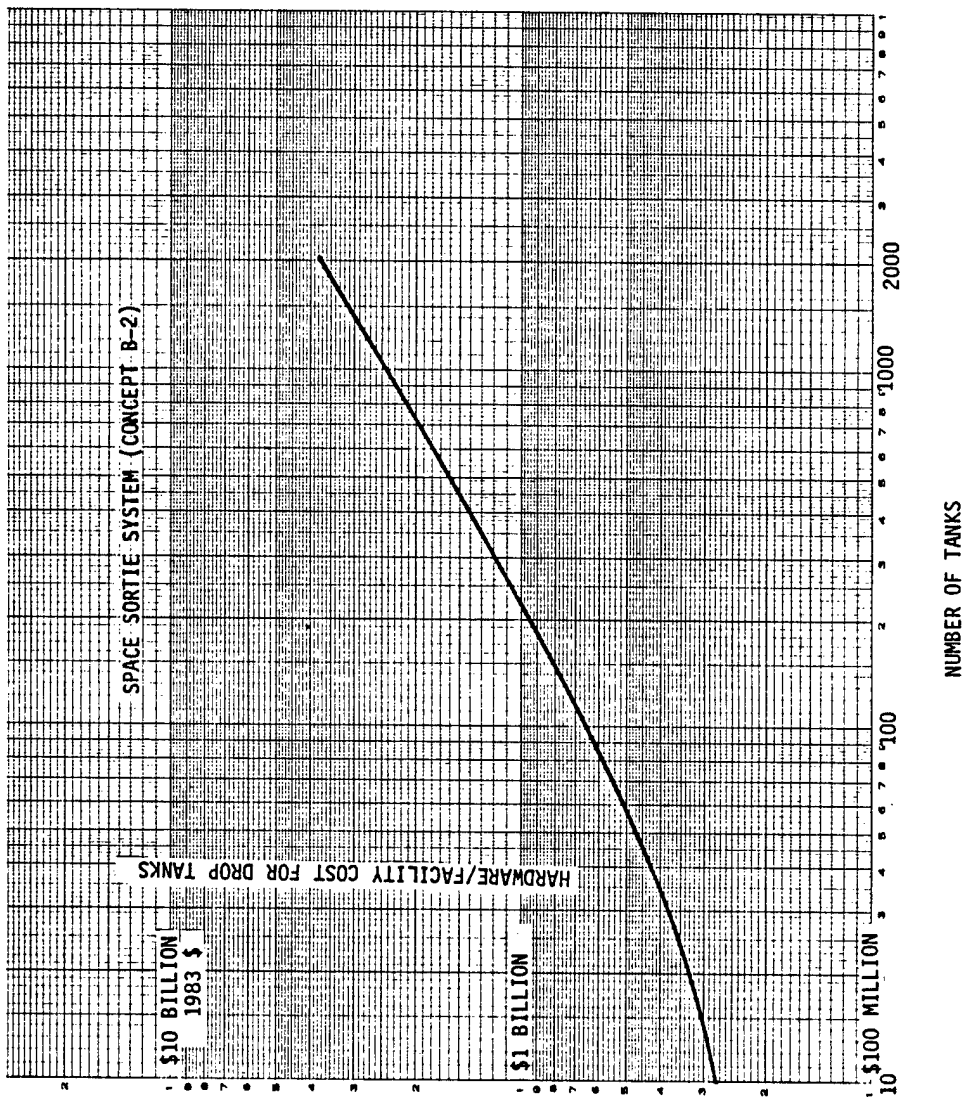

**BOEING PROPRIETARY**

## PRELIMINARY SORTIE SYSTEM COSTS (1983 DOLLARS)

- Development and production costs of the Sortie Vehicle, 747 Carrier and Drop Tank were estimated using the Boeing Aerospace Company's parametric cost model (PCM).
- PCM uses inputs consisting of dry weight (breakdown), platform factors, complexity factors, material factors, learning curves, schedule factor and commonality estimates. Outputs are engineering and developmental shop manhours and dollars for design and development and basic factory labor hours and dollars, material dollars, and support cost dollars for DDT&E and production of the vehicle fleets.
- PCM utilizes cost-estimating relationships (CER's) developed from Boeing and industry experience.
- DDT&E Costs include design and fabrication of one 747 carrier vehicle and two sortie vehicles for flight test. Design and development of the expendable drop tanks is shown in the "other" column. The test program includes six orbital flights.
- Hardware/Facility Investment Costs include production tooling for orbiters and carrier vehicles and drop tanks (shown as "Preproduction Facilities"). Vehicle production includes 50 sortie vehicles and 10 747 carrier aircraft. Air Force facilities include cryogenic storage and pumping stations at 10 SAC bases plus maintenance and ground-support equipment.
- Operations Costs - The conservative personnel costs shown were estimated by analogy to Space Shuttle operations rather than by using a TAV project generated operational manning profile. Propellants and maintenance spares reflect 100 flights/yr from 10 bases over a 20-yr period. Drop tank costs (shown as "other") are cumulative costs for 2000 tanks produced in a semi-automated facility on an 80% learning curve.

**BOEING PROPRIETARY**  
**Preliminary TAV System Costs (1983 Dollars)**

SPACE SORTIE SYSTEM (CONCEPT B-2)

D180-27669-4

253

TAV COST SCENARIO(1) DATA(2)

Cost Category	Costs in Millions \$			Total
	TAV Orbiter	Booster/Carrier Systems	Other	
<b>DOT&amp;E Costs</b>				
Systems design				
Test Articles Fabrication and Technology Development				
Ground & Flight Tests and Evaluation				
Subtotal	2,440	1,060	700	4,200
<b>Hardware/Facility Investment Costs</b>	280	40	185	505
Preproduction Facilities <sup>(Tooling)</sup>				
Vehicle Production	7,070	1,980	-	9,050
Air Force Facilities			1,110	1,110
Support Equipment			769	769
Subtotal	7,350	2,020	2,064	11,434
<b>Operations Costs</b>	16,920	900		17,820
Personnel (Number/Type/Costs)				
TAV System Propellants			800	800
Repair Parts/Spares	5,300	600		5,900
Other <sup>Drop Tanks</sup>			3,600	3,600
Subtotal	22,220	1,500	4,400	28,120
<b>Scenario TAV Program Totals</b>	32,010	4,580	7,164	43,754

Notes: BOOSTER/TAV RATIO: 1 TO 5

1. TAV Production Scenario Assumptions

(a) Fleet size: Orbiters -50 (production and delivery of 10 orbiters per year between 1995 - 2000)

Booster/Carriers - Number required to support orbiter space flights (constant ratio)

(b) Flight Rate: 100 flight per year

(c) Operational Period: 20 years

2. If other primary uses and missions are envisioned for the boosters/carriers, additional cost analyses can be presented using this format to show the benefits of concurrent usage. These data should be accompanied by a full exposition of the assumed complementary usage scenario including the rationale for expecting that it will develop.



THIS PAGE INTENTIONALLY LEFT BLANK

### **3.2.4 Technology Risk Assessment**

### **3.2.5 Requirements Compliance**

### **3.2.6 Conclusions**

CONCEPT B-2 TECHNOLOGY/RISK ASSESSMENT

The major subsystems shown were selected for innate low risk. However, some additional statements could be made. The structures selected are low risk because they use existing technology; however, if additional work is done in design and development and if the current advances in other systems are followed, there is a good possibility that major weight savings would be available for a moderate additional investment.

The thermal protection system uses existing shuttle-type technology; however, the risk is termed moderate because of the so-called all-weather requirement. This all-weather requirement needs to be defined. Is it hail stones 2 inches in diameter, or just rain? And note that the durability of the ceramic thermal protection system is rapidly increasing, probably more rapidly than any other of the technologies being investigated. The ceramic protection system is becoming more flexible and more durable all the time, so in the timeframe considered, the ceramic-type thermal protection system could meet all requirements, including the all-weather requirement.

## CONCEPT B-2 TECHNOLOGY/RISK ASSESSMENT (continued)

The propulsion system selected used existing engines, which is low risk. However, there is a possibility of performance advantages to going with a derivative of the SSME or possibly a new engine. The SSME was not designed for this type of vehicle. It is a low thrust-to-weight engine which required high pressure because of the fact that it took off from sea level. For an air launch vehicle, a lower pressure higher thrust-to-weight engine could provide enhanced performance.

Guidance, navigation and control use an existing technology. However, the implications of launch-on-demand characteristics cannot be more overstated. Much more work needs to be done. Currently thousands of manhours are spent defining the mission, operations, and programming, and the fact that launch is desired in an hour to a half an hour and less, necessitates totally canned and preprogrammed missions. It is going to require some great advances in technology to build into the guidance control system the flexibility required. And, of course, the abort is an open issue too. If one doesn't know the mission very far in advance to all possible abort conditions and a programming into the computer the right movement and abort condition is definitely a technology issue.

The reaction control system currently uses STS technology because that is all the database that is available; however, it is very desirable to move to a nonhazardous propellant, especially like LO<sub>2</sub>/hydrogen and LO<sub>2</sub>/propane because it could be stored supercritical and a LO<sub>2</sub>/hydrocarbon-type RCS database would be very useful.

CONCEPT B-2 TECHNOLOGY/RISK ASSESSMENT (continued)

The other subsystems relevant to a manned vehicle, the electronic power, some of the actuators, are low risk because basically these components are already being developed now for more advanced versions of the shuttle.

The carrier aircraft itself is viewed as low risk because it uses existing technology, it is an aluminum airframe. It is a straight-forward derivative of the 747. The lightweight propellant dewars were developed originally as a possible LO<sub>2</sub>/LH<sub>2</sub> OMS system for the Space Shuttle but they were not of the size needed. These dewars require lives of thousands of hours, so they need more definition. We put that down as a technology risk.

The drop tank itself, as defined, is viewed as low risk because we are using aluminum. If weight decreases are needed, it may be necessary to use more composites on the drop tank, and this would imply additional technology risk and additional investment.

## Concept B-2 Technology/Risk Assessment

- STRUCTURES—LOW RISK, USES EXISTING TECHNOLOGY
  - MAJOR WEIGHT SAVINGS AVAILABLE FOR ADDITIONAL INVESTMENT
- TPS—USES EXISTING TECHNOLOGY BUT RISK IS MODERATE BECAUSE OF "ALL WEATHER" REQUIREMENT
  - "ALL WEATHER" NEEDS MORE DEFINITION
- PROPULSION—LOW RISK, USES EXISTING ENGINES
  - AIR-START OF SSME NEEDS MORE WORK
- GUIDANCE, NAVIGATION AND CONTROL—USES EXISTING TECHNOLOGY BUT IMPLICATIONS OF LAUNCH-ON-DEMAND NEED BETTER UNDERSTANDING
  - ABORT CAPABILITY IS AN OPEN ISSUE
- RCS—CURRENTLY USING STS TECHNOLOGY BUT MOVE TO NON-HAZARDOUS MATERIALS (LO<sub>2</sub>--HC) RECOMMENDED TO AID TURNAROUND TIME
  - DEVELOP LO<sub>2</sub>--HC RCS DATA BASE
- OTHER SUBSYSTEMS—LOW RISK, USES EXISTING COMPONENTS
- CARRIER AIRCRAFT—LOW RISK, STRAIGHTFORWARD DERIVATIVE
  - LIGHTWEIGHT PROPELLANT DEWARs NEED MORE DEFINITION
- DROP TANK—LOW RISK, USES EXISTING TECHNOLOGY
  - MAJOR WEIGHT SAVINGS AVAILABLE FOR ADDITIONAL INVESTMENT

## CONCEPT COMPLIANCE WITH OPERATIONAL REQUIREMENTS AND DESIGN OBJECTIVES

The stage-and-a-half air-launch TAV with its autonomous capability, its flexibility of operation, and its potential low development cost should be able to meet or exceed the TAV operational requirements. The 747 derivative airplane is capable of operating out of more than 800 air fields worldwide, which means the vehicle is capable of operating out of anywhere in the world. The system has a capability of launching two missions per day using the single-carrier aircraft. It is more cost effective to buy additional orbiters and integrate the payload with the orbiter and with an external tank well in advance and then integrate that system into the orbiter as required on a quick-turnaround basis. This is based on the fact that studies looking at shuttle orbiter characteristics have shown that it is very time-consuming to integrate the payload into an orbiter unless the orbiter and the payload both are made with universal type fittings which tend to be very bulky and heavy. As noted, the system is not completely reusable as it drops tanks but, depending on the mission model and the number of flights flown, this system could easily have life cycle cost less than some of the reusable system candidates.

BOEING PROPRIETARY

# Concept Compliance with Operational Requirements & Design Objectives

- THE STAGE AND A HALF AIR LAUNCHED TAV (CONCEPT B-2) CAN MEET OR EXCEED ALL THE BASELINE OPERATIONAL REQUIREMENTS. THE 747 DERIVATIVE CARRIER AIRCRAFT CAN OPERATE OUT OF MORE THAN 800 AIRFIELDS WORLDWIDE.

## DESIGN OBJECTIVES ACHIEVED

- 5 MINUTE LAUNCH PLUS POTENTIAL OF AIRBORNE ALERT.
- 2 MISSIONS/DAY TURNAROUND FOR THE CARRIER AIRCRAFT
  - MORE COST EFFECTIVE TO BUY ADDITIONAL ORBITERS (THEY'RE SMALL) AND INTEGRATE THE PAYLOADS AND DROP TANKS IN ADVANCE.
  - TURNING AN ORBITER AROUND IN LESS THAN 24 HOURS WILL REQUIRE MANY COMPROMISES TO THE STRUCTURE, SUBSYSTEMS AND PAYLOADS WHICH WILL TEND TO INCREASE INERT WEIGHT AND IMPACT MISSION CAPABILITY
- THIS SYSTEM IS NOT COMPLETELY REUSABLE BUT MAY HAVE LIFE CYCLE COSTS COMPETITIVE WITH REUSABLE CONCEPTS DEPENDING ON MISSION MODEL.



CONCEPT COMPLIANCE WITH OPERATIONAL REQUIREMENTS  
AND DESIGN OBJECTIVES (continued)

The concept has 5,000 lb capability to once-around polar orbit--that's with the standard engines in existing technology. If more advanced engines are added to replace the SSME and the RL10's, then the payload will increase by approximately 4,000 lb. If more advanced structure and TPS are incorporated, it would add another 1200 lb of capability. If the 747 is improved such as by hydrogen duct-burning engines, we would expect considerable payload capability growth. These enhancements indicate that there's considerable growth capability left in the basic system as presented. Because the internal tanks are covered with foam, with low-boiloff characteristics, the vehicle could spend appreciable time on orbit if either solar panels or fuel cells and a better life-support capability is added to the system.

## Concept Compliance with Operational Requirements & Design Objectives (Continued)

D180-27669-4  
263

- THIS CONCEPT IS NOT A SINGLE STAGE SYSTEM
- SINGLE STAGE DESIRABLE FOR GROUND HANDLING
- SSTO'S ARE HIGHER DEVELOPMENT RISK
- BASELINE PAYLOAD—5000 POUNDS TO LOW POLAR ORBIT
- ADVANCED ENGINES ADDS 4000 LBS
- OTHER TECHNOLOGY ADVANCES (15 → 10% WEIGHT GROWTH) ADD 1200 LBS
- CONCEPT PAYLOAD LIMITED BY 747 CARRY CAPABILITY
- THIS CONCEPT CAN SPEND DAYS ON-ORBIT WITH ADDITIONAL OMS PLUS EPS AND LSS KITS
- INTERNAL PROPELLANT TANKS ARE DESIGNED FOR LOW ON-ORBIT BOILOFF
- BATTERIES REPLACED WITH FUEL CELLS
- ADDITIONAL O<sub>2</sub> AVAILABLE FROM FUEL CELL TANKS

**BOEING PROPRIETARY****CONCLUSIONS**

The principal conclusion is that the stage-and-a-half TAV concept is viable as a low-risk system. It becomes less a technology challenge than an engineering challenge. It has significant development advantages over some of its competing systems. Because of the stage-and-a-half it reduces the performance sensitivity. An increase in inert weight, unless it is a very significant, will not jeopardize the payload capability. It has a very low ascent dynamic pressure which means that structurally it doesn't have to have a lot of heavy materials to withstand the ascent loads and it has a relatively low planform loading, much lower than the shuttle, for instance, which means that we are not pushing our thermal protection system technology at all.

Since it is integrated with an airplane, and because the propellant is stored internally in vacuum dewars, we do not have any cryo ground-hold problems. We do not have to worry about liquid air forming on the vehicle during rainy periods when we are in our ground-hold configuration.

We have that inherent flexibility in the way we operate. We meet the fundamental criteria for this class of vehicle and beyond that we offer some unique capabilities. Number one is the fact that we are dispersible, we can go on alert, we can be flush and then return. Because we can operate worldwide and therefore cannot be continuously observed, we have the possibility of covert launch capability. Of course we have the all-azimuth launch capability because we can pick our launch point such that we drop the external tank into an uninhabited spot; that is, assuming it doesn't burn up, but we still think we can design a drop tank which will be totally consumed by reentry.

Another point to make is that a design goal of 20,000 lb for this class of vehicle for a TAV appears to push existing technology pretty hard, either that or the system is going to get awfully, awfully big and those two things combined indicate that maybe a payload less than 20,000 lb would be more compatible with the level of funding available for this class of vehicle and for future mission requirements. Two-million-pound-launch TAV's may not be terribly desirable, both from a cost standpoint and an operational standpoint. Beyond the TAV-type missions, the concept if properly selected could have potential to be a basis for all Air Force space transportation requirements.

## Conclusions

### CONCEPT B-2

- CONCEPT IS VIABLE--AN ENGINEERING RATHER THAN A TECHNOLOGY CHALLENGE WITH:
  - SIGNIFICANT DEVELOPMENT ADVANTAGES:
    - STAGE AND A HALF + LAUNCH AIRCRAFT REDUCES PERFORMANCE SENSITIVITIES
    - SYSTEM USES EXISTING TECHNOLOGY THROUGHOUT
    - LOW ASCENT DYNAMIC PRESSURE AND LOW REENTRY PLANFORM LOADING RELATIVE TO STS
    - INTEGRATED FLIGHT SYSTEM EASES:
      - CRYO GROUND HOLD PROBLEMS
      - FLEXIBLE BASING ISSUES
      - MISSION DATA LOAD REQUIREMENTS
  - SYSTEM MEETS FUNDAMENTAL CRITERIA AND OFFERS UNIQUE CAPABILITIES:
    - DISPERSIBLE -- ALERT STATUS
    - WORLDWIDE, COVERT LAUNCH -- ANY AZIMUTH
    - RECALLABLE -- AIRBORNE ALERT
  - A DESIGN GOAL OF LESS THAN 20,000 LBS PAYLOAD MAY BE MORE COMPATIBLE WITH USAF TECHNOLOGY FUNDING AND FUTURE MISSION REQUIREMENTS
  - CONCEPT HAS THE POTENTIAL TO BE THE BASIS FOR AN AIR FORCE SPACE TRANSPORTATION SYSTEM

POTENTIAL AIR FORCE SPACE TRANSPORTATION SYSTEM  
BASED ON AIR LAUNCHED SORTIE SYSTEM

This chart depicts several alternate launch system concepts using Sortie vehicle and space shuttle hardware if much larger payloads or payloads to much higher orbits are deemed necessary. This shows the way a TAV-class vehicle can be used as a reusable engine module for a large shuttle-derived cargo launch vehicle or the carrier aircraft itself could be used as a platform for a responsive unmanned launch vehicle which we have the capability of putting about 25,000 lb into lower Earth orbit or almost 8,000 lb into geosynchronous orbit. This would give the Air Force some interesting additional capabilities.

BOEING PROPRIETARY

# Potential Air Force Space Transportation System Based on Air Launched Sortie System

D180-27669-4  
267

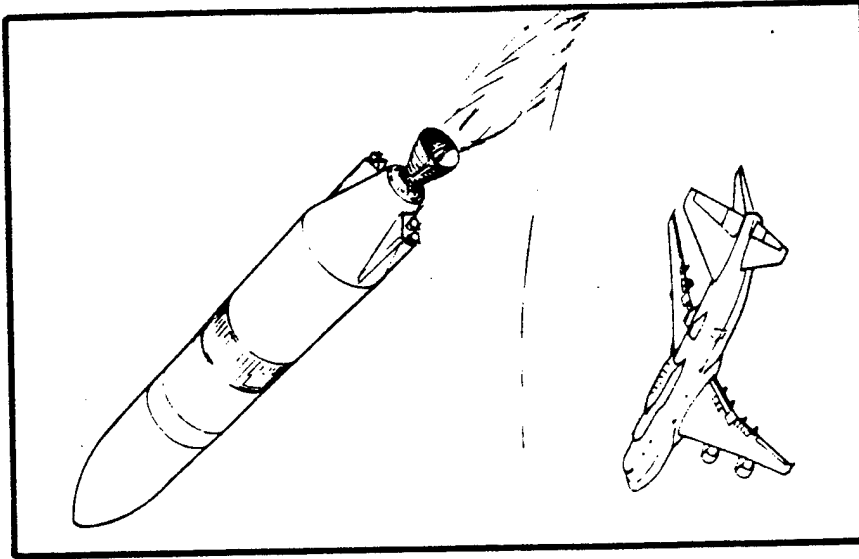

RESPONSIVE UNMANNED  
LAUNCH

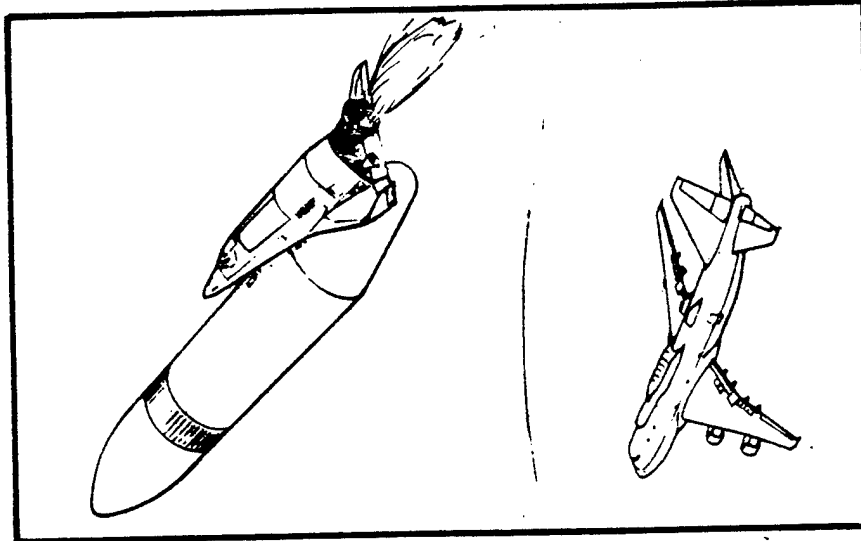

MANNED AIR-LAUNCHED  
SORTIE VEHICLE

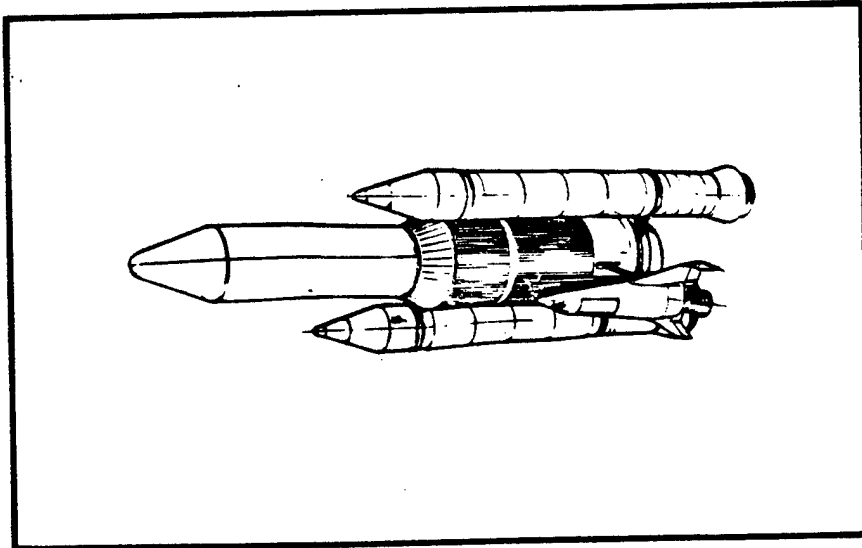

COST EFFECTIVE CONVENTIONAL  
LAUNCH USING SHUTTLE  
DERIVED HARDWARE AND ALSV



BOEING PROPRIETARY

EXTERNAL TANK PARTICLE FALLOUT

Upon depletion of 344,450 lb of propellant contained in the External Tank, the tank is separated from the manned orbiter. At this point, the vehicle is at a relative velocity of 21,500 ft/s, altitude of 304,000 ft and 2.1 deg flight-path angle. The External Tank lofts to an altitude of approximately 325,000 ft then plunges into the atmosphere. The tank's kinetic energy is dissipated in the form of aerodynamic heating. Preliminary analysis indicates this heating is sufficient to completely consume the tank's structure and systems, leaving, at most, small particles to reach the surface. If these particles survive entry, they will fall into a band which, depending upon launch azimuth, lies 1340 nmi west, 1580 nmi north and south, or 1780 nmi east. This band is shown in the figure with Carswell AFB as the launch site.

BOEING PROPRIETARY

# External Tank Particle Fallout

D180-27669-4  
269

ASSUME: ROCKET IGNITION  
OVER LAUNCH SITE

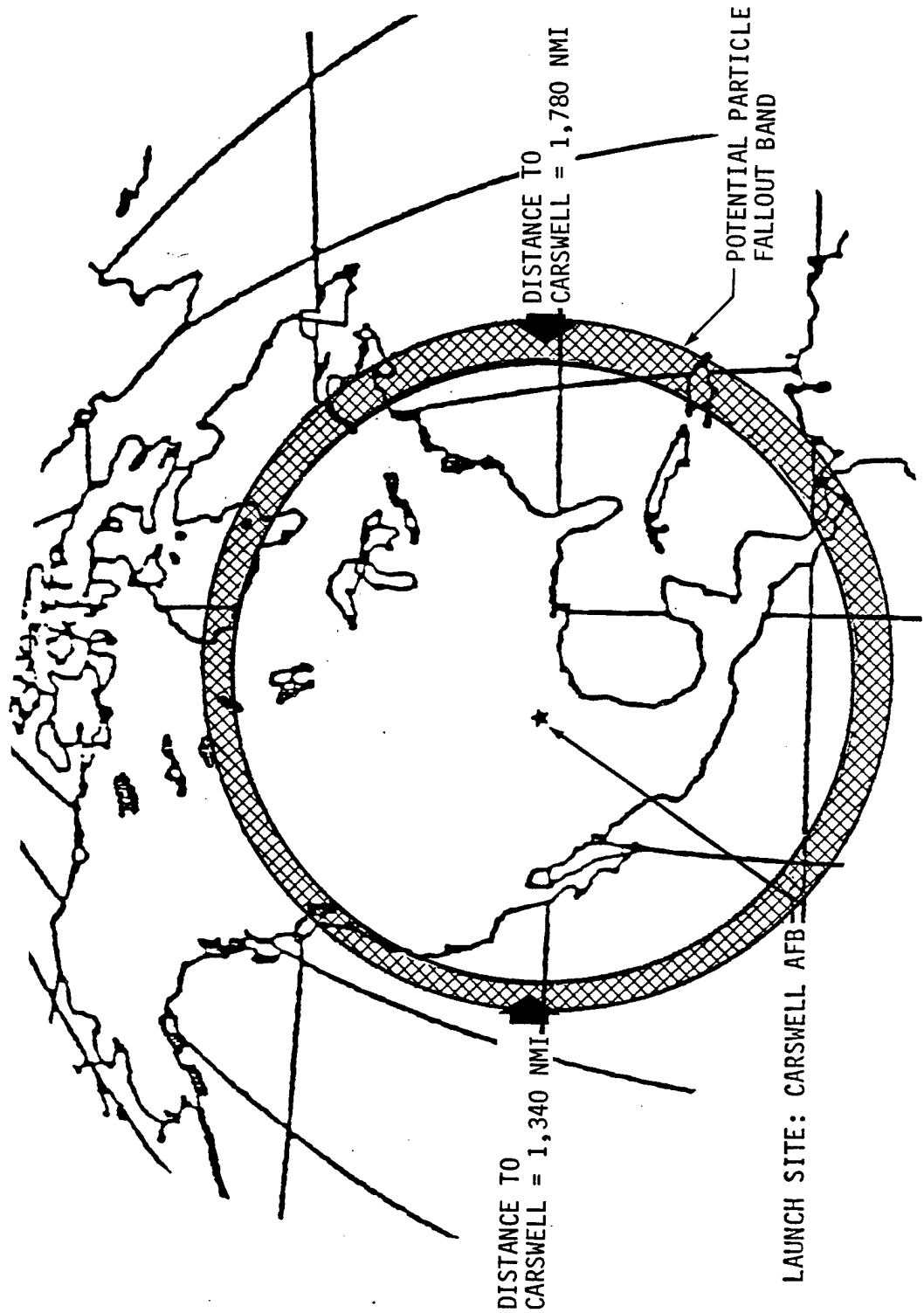

LAUNCH SITE: CARSWELL AFB

DISTANCE TO  
CARSWELL = 1,340 NMI

DISTANCE TO  
CARSWELL = 1,780 NMI

POTENTIAL PARTICLE  
FALLOUT BAND



### **3.3 Reusable Aerodynamic Space Vehicle (RASV) (Concept B-3)**

### 3.3.1 Detailed Concept Definition

Advanced Spaceflight/Transportation System Concept Studies were initiated in 1972 with the purpose of defining those technology developments required to provide low cost spaceflight transportation with operational flexibility and characteristics similar to airplanes.

Utilizing system and technology developments as demonstration of potential space transportation capabilities, SAC, ADCOM, Space Division and the Air Staff sequentially documented "Advanced Military Spaceflight, General Operating Requirements and Mission Element Needs."

Through a combination of Boeing Internal Research, NASA, and Air Force sponsored System Studies and Technology Development Tasks, concept verification was demonstrated for fully reusable Earth to spaceflight transportation systems. These developments have been directed toward fulfilling Military requirements that include:

- "On Demand" Access to Space
- ConUS to ConUS Flight
- Low cost, fully reusable systems that provide access to all Earth orbital tracks.
- Orbital payloads of sufficient size to accomplish "Orbit Change Missions" and/or terrestrial force deployment.

## REUSEABLE AERODYNAMIC SPACE VEHICLE

The Reuseable Aerodynamic Space Vehicle (RASV) was evolved under Air Force contracts. It is a fully reusable system, takes off horizontally supported by a wheeled ground accelerator, turns into the desired flight trajectory, either flies ConUS to ConUS or into orbit and at the end of the mission performs a horizontal landing.

The RASV will be used in the following charts to illustrate the technology base, system design, and performance capability of an Advanced Military Spaceflight System.

BOEING PROPRIETARY

# Reusable Aerodynamic Space Vehicle (RASV)

D180-27669-4

273

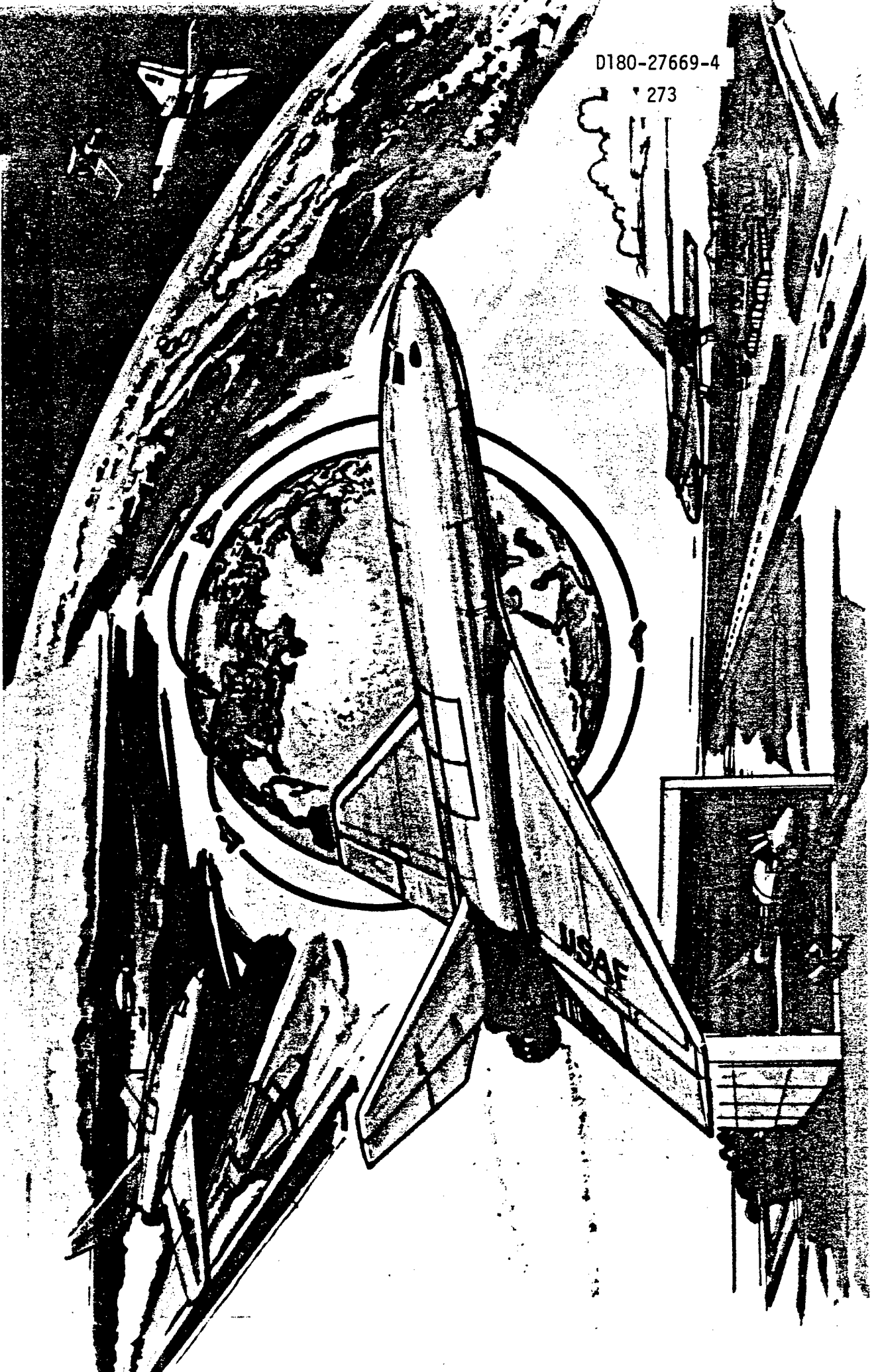

## RASV OPERATIONS PROFILE

The Boeing Advanced Military Spaceflight studies have supported the evolution of the Rocket Powered Aircraft. The RASV represents a two engine configuration of this class of vehicle.

The operation profile used for spaceflight is shown. The vehicles take off horizontally. The RASV as an example is set on the ground accelerator at an angle of attack of  $8^{\circ}$ . Lift-off occurs at 550 ft/sec. An aerodynamic lifting trajectory is flown through the sensible atmosphere. Either orbital or once-around flight is possible. During reentry, vehicle aerodynamic planform loading is held low (approximately 22 pounds/foot<sup>2</sup>), thus keeping temperatures to levels compatible with extensive use of the superalloys. The low wing loading provides for good cross range and relative low landing velocities and altitudes.

The ability for take-off site escape is significant in that within 200 seconds after engine ignition, start of take off, the aircraft is 50 miles down range at an altitude of 120,000 feet. Further, during this flight phase, aerodynamic maneuvers may be performed to acquire any heading within plus or minus  $95^{\circ}$  of the take off direction.

BOEING PROPRIETARY

# RASV Operations Profile

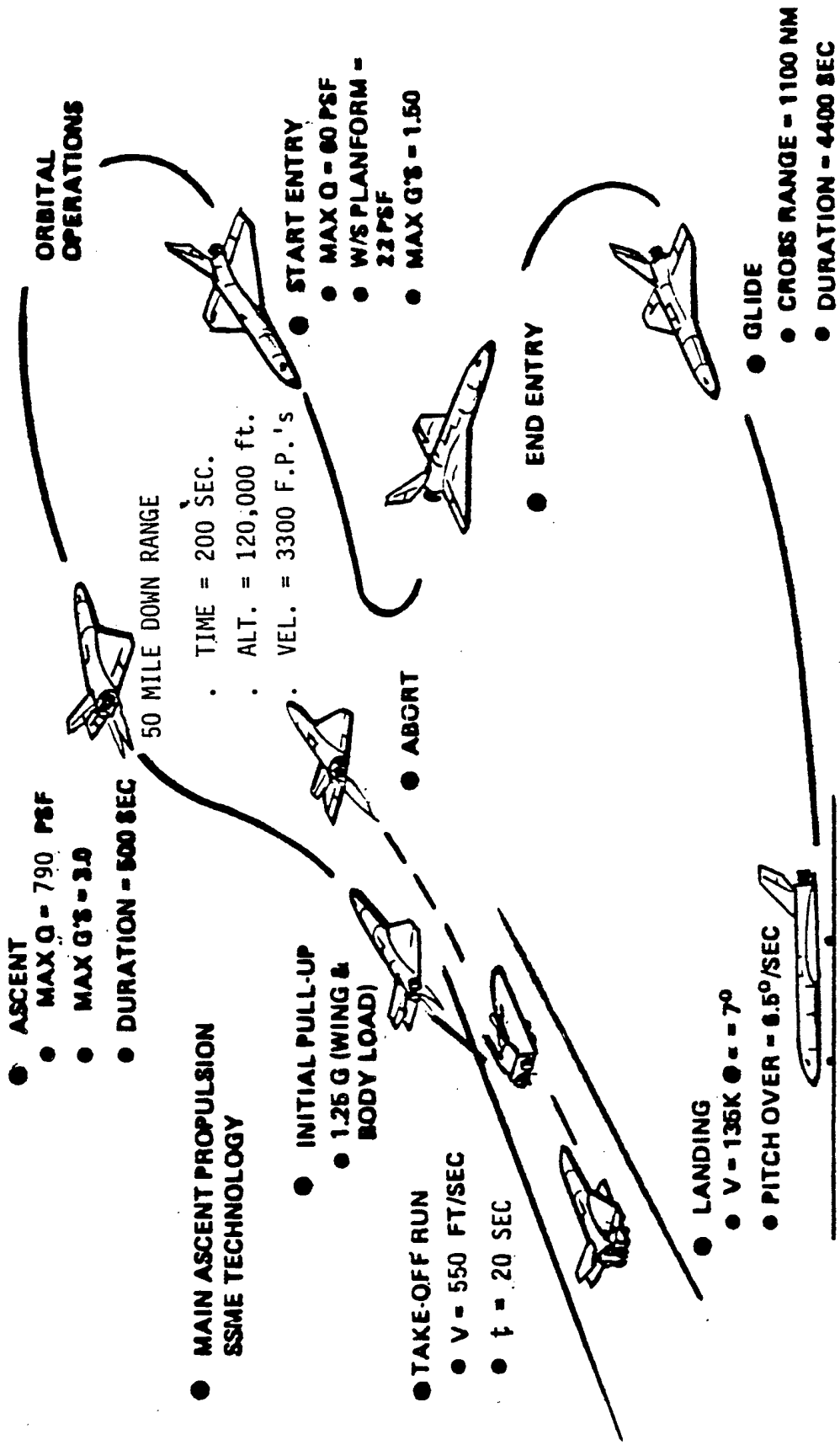

## BOEING PROPRIETARY

## REUSABLE AERODYNAMIC SPACE VEHICLE (RASV)

The Boeing Advanced Military Spaceflight studies have supported the evolution of the Rocket Powered Aircraft. The Reuseable Aerodynamic Space Vehicle (RASV) represents a two engine configuration of this class of vehicle.

The Rocket Powered Aircraft take off horizontally, perform an aerodynamic turn to the desired headings and then either fly ConUS to ConUS returning to preselected airports, one of which may be the take off site, or fly into a 100 nautical mile earth orbit. The terminal phase of flight is unpowered. A horizontal landing is performed. The aircraft is moved on its landing gear by tow truck during all ground operations. During the take off run, the aircraft is supported by a fully reuseable powered wheeled ground sled.

The RASV operation is as follows. The RASV is set on the take off support vehicle at an angle of attack of 8°. Lift-off occurs at 550 ft./sec. An aerodynamic lifting trajectory is flown through the sensible atmosphere. Either orbital or once-around flight is possible. Dying reentry, vehicle aerodynamic planform loading is held low (approximately 22 pounds/foot<sup>2</sup>), thus keeping temperatures to levels compatible with extensive use of the superalloys. The low wing loading provides for good cross range and relative low landing velocities and attitudes.

The ability for take off site escape is significant in that within 200 seconds after engine ignition, start of take off, the aircraft is 50 miles down range at an altitude of 120,000 feet. Further, during this flight phase, aerodynamic maneuvers may be performed to acquire any heading within plus or minus 95° of the take off direction.

The horizontal take off/horizontal landing fully reuseable spaceflight vehicles have characteristics that are consistent with the operating command operational requirements. Further, they provide configurations and weight distributions that result in aerodynamically stable systems.

The ability to fly like an airplane at thrust to weights as low as .3 results in good abort performance and acceptability for inland siting.

The significantly lower gross weight, fewer engines and simplified ground handling procedures result in major reductions to operating costs.

# Reusable Aerodynamic Space Vehicle

DESIGN DATA

WEIGHTS									
GLOW									
INJECTED									
WING									
REFERENCE AREA									
EXPOSED AREA									
CONTROL SURFACE AREA									
ASPECT RATIO									
SECTION									
FIN									
AREA									
ASPECT RATIO									
SECTION									
VOLUME/PROPELLANT WEIGHTS									
WING LO <sub>2</sub> TANKS									
BODY LH <sub>2</sub> TANKS									
PROPULSION									
THRUST (SEA LEVEL)	LB								
THRUST (VACUUM)	LB								

1.22 x 10<sup>6</sup> LB.  
155,760 LB.

5,632 FT.<sup>2</sup>  
3,992 FT.<sup>2</sup>  
638.55 FT.<sup>2</sup>  
2.06  
11.49%

450 FT.<sup>2</sup>  
1.21  
8%

13,807 FT.<sup>3</sup>  
37,453 FT.<sup>3</sup>  
934,890 LB.  
155,824 LB.

EXPANSION RATIO  
50:1 150:1

471,600  
534,030  
550,360

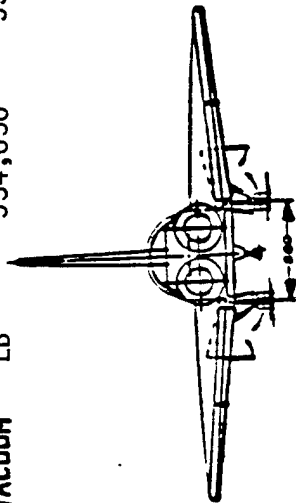
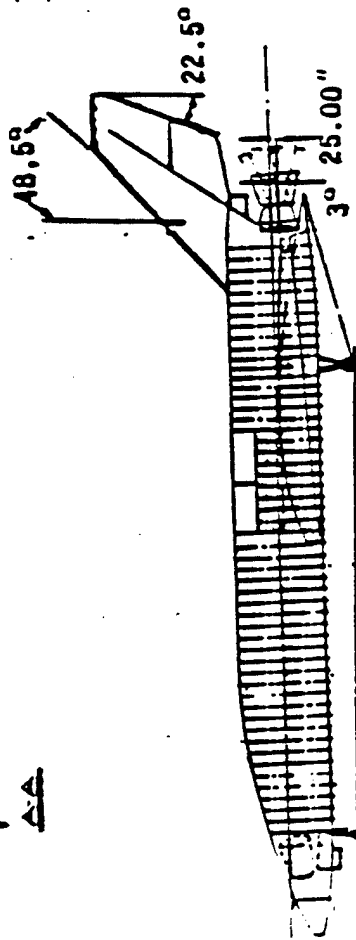
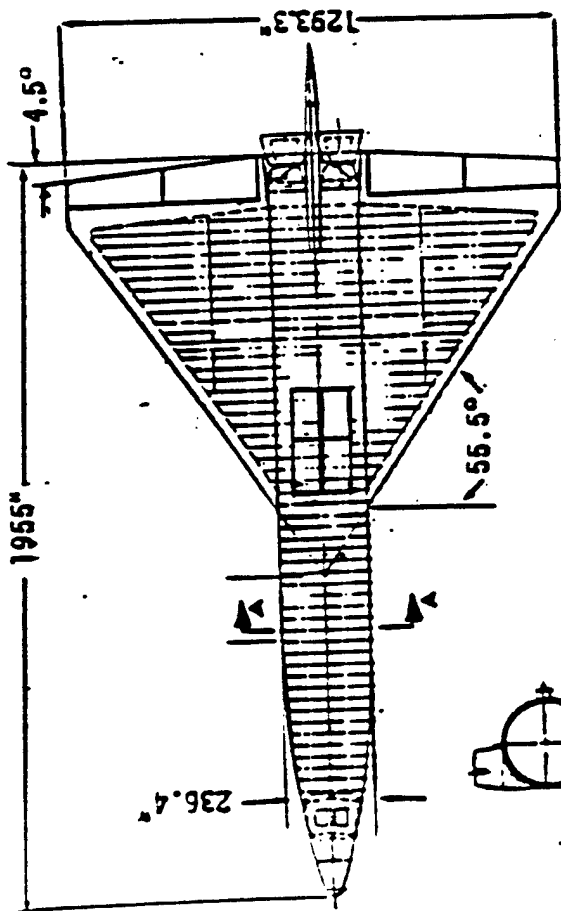



## RASV STRUCTURAL CONCEPT

The reentry temperature controlled by low planform reentry loading coupled with the unique characteristics of the honeycomb system, shown in the vehicle cross sections, permit use of honeycomb systems for external vehicle surfaces with no additional insulation. The honeycomb systems are multifunctional providing insulation for the cryogenic liquids as well as load transfer.

The vehicle depicted (RASV) uses two Space Shuttle Main Engines and Space Shuttle Auxiliary Power Units, Attitude Control Systems, etc. The Space Shuttle Program will mature the system. Technical analysis of the performance of these subsystems is shown in Air Force RASV documents.

# RASV Structural Concept

D180-27669-4  
279

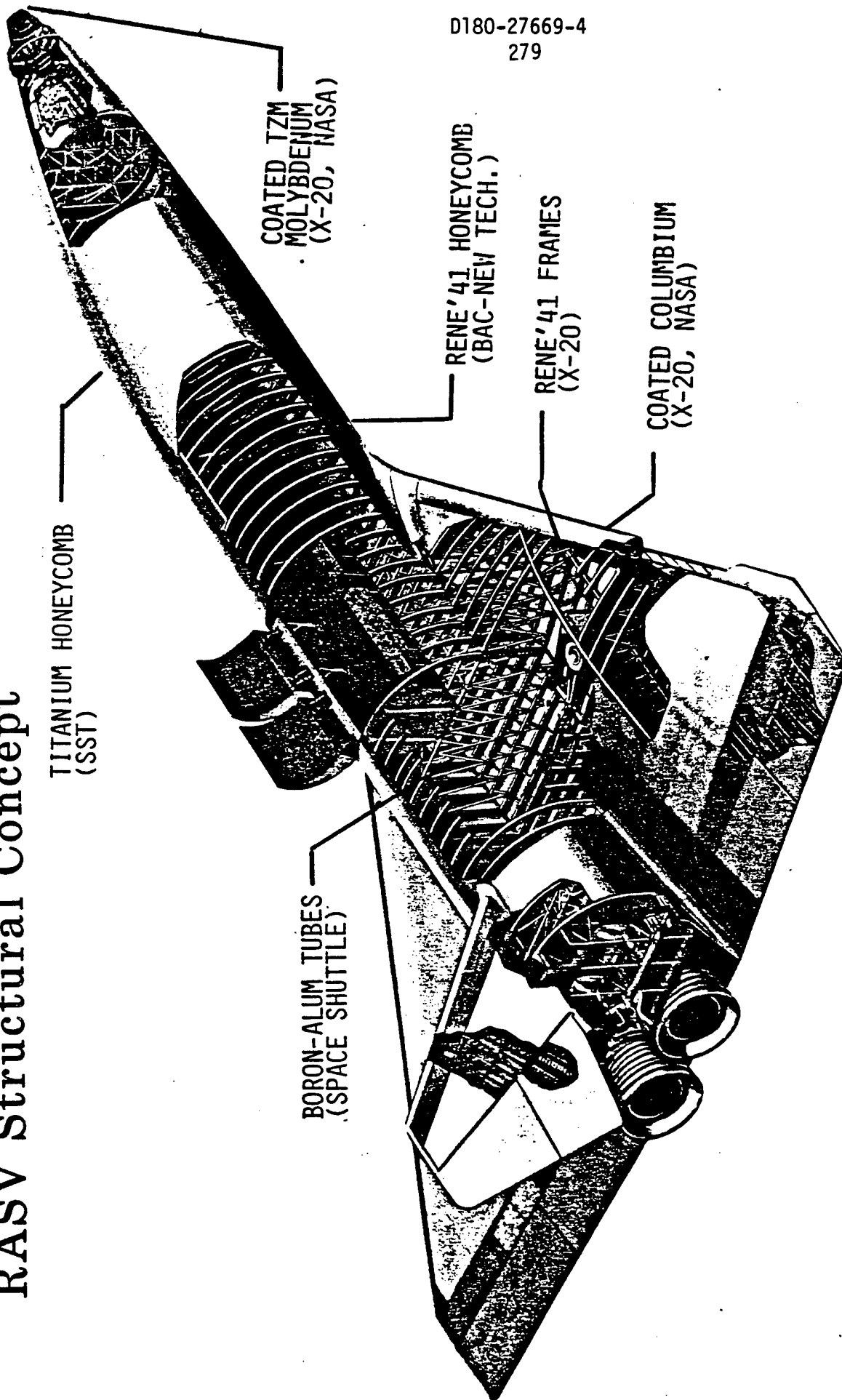

( ) TECHNOLOGY SOURCE

BOEING PROPRIETARY

EXTERNAL TEMPERATURE DISTRIBUTION

Shown are thin skin, insulated wall maximum temperature experienced during reentry for a rocket airplane (RASV) that has a reentry aerodynamic planform loading of 22 pounds/foot<sup>2</sup>. The trajectory is for the polar flight, once-around mission with full payload recovery. Lateral range is slightly over 1200 n.mi. Extending the lateral range 300 to 400 n.m. would increase temperature approximately 200°F. With cross radiation (bottom to top) available, these temperatures will drop approximately 100°F.

BOEING PROPRIETARY

# External Temperature Distribution

ADVANCED  
EARTH ORBIT  
TRANSPORTATION  
SYSTEMS  
P-3 AND S-3 AIRCRAFT COMPANY

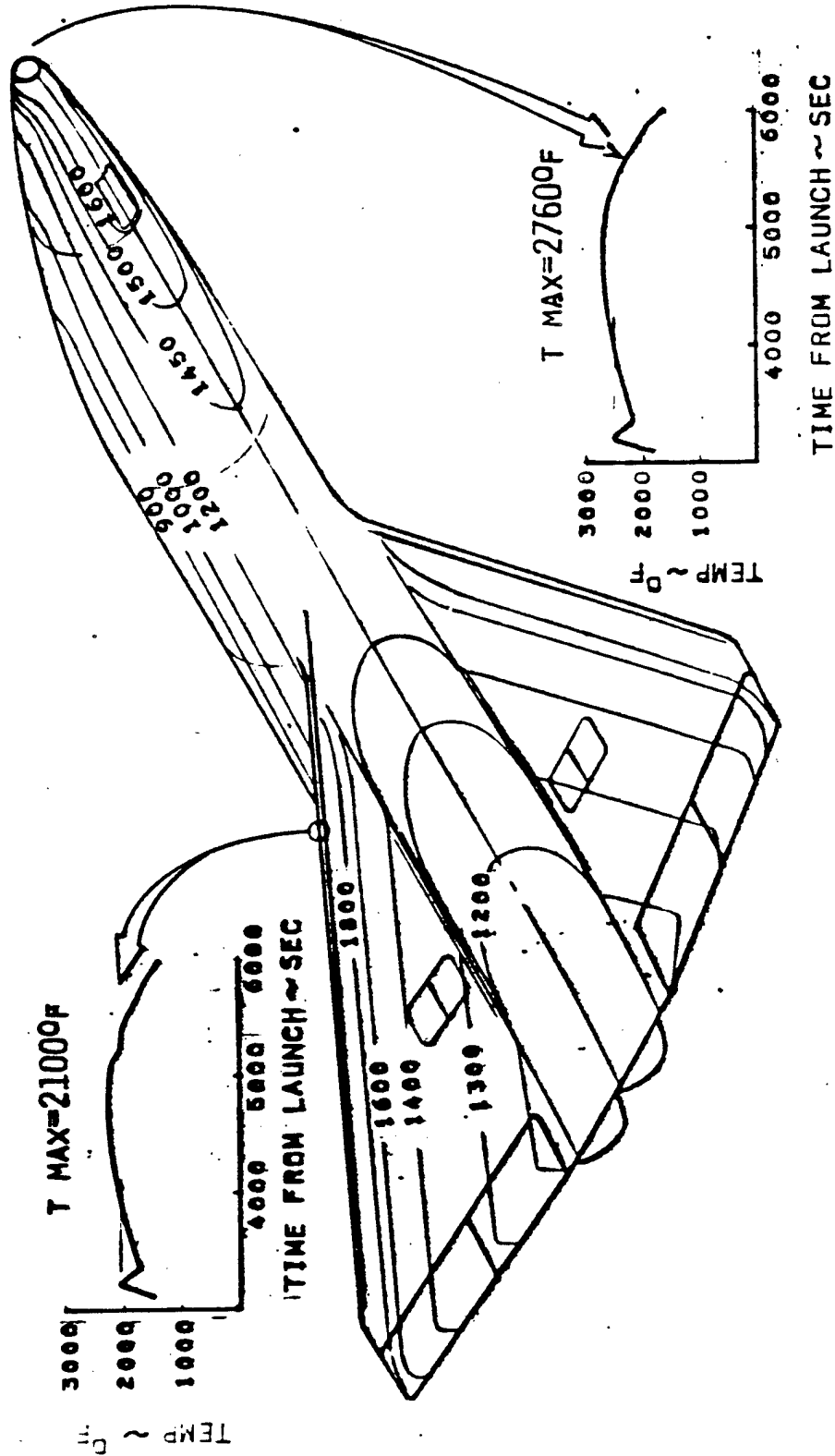

BOEING PROPRIETARY

# RASV Propulsion System

D180-27669-4  
282

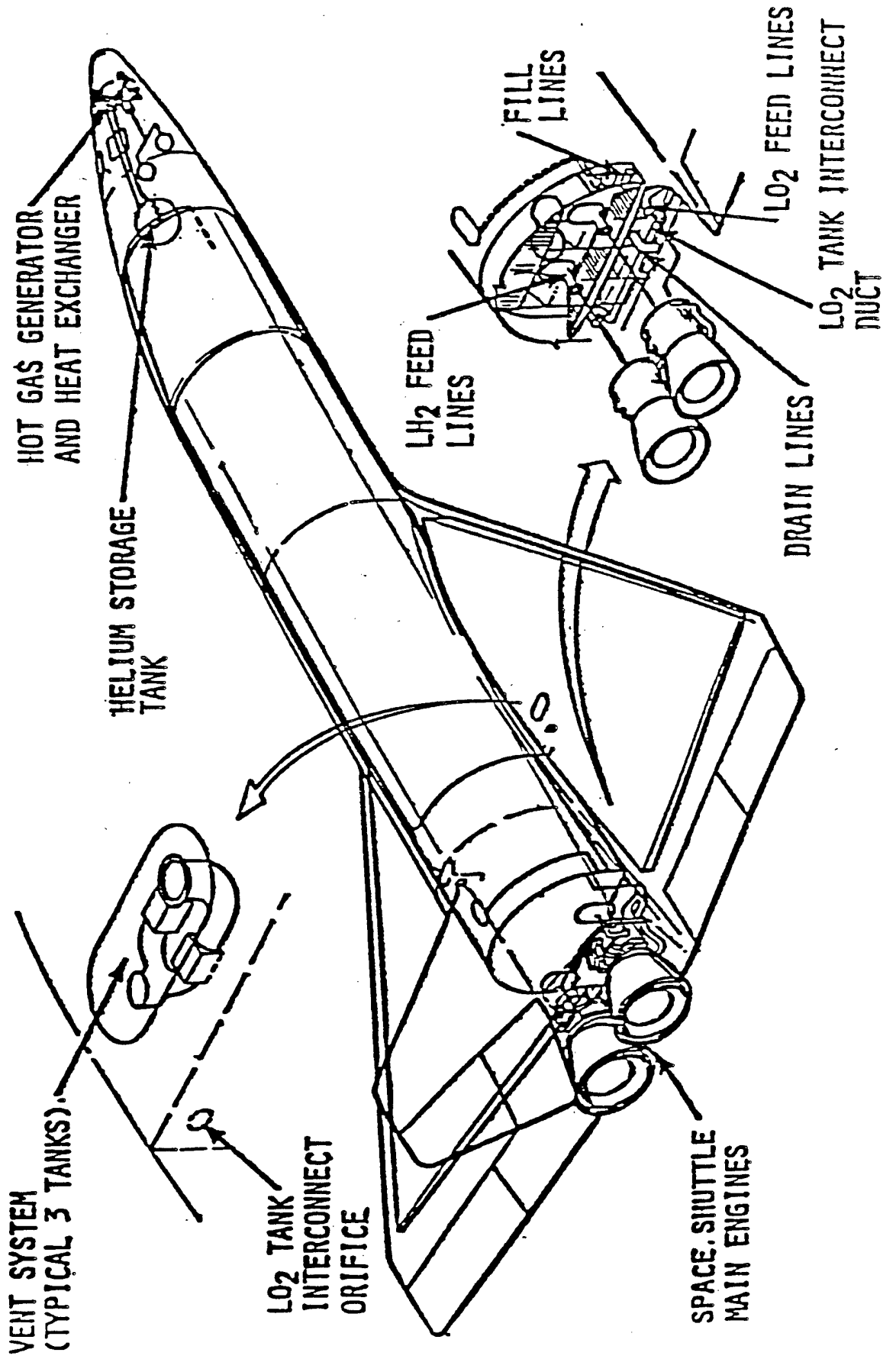

BOEING PROPRIETARY

# Main Ascent Engine

D180-27669-4

283

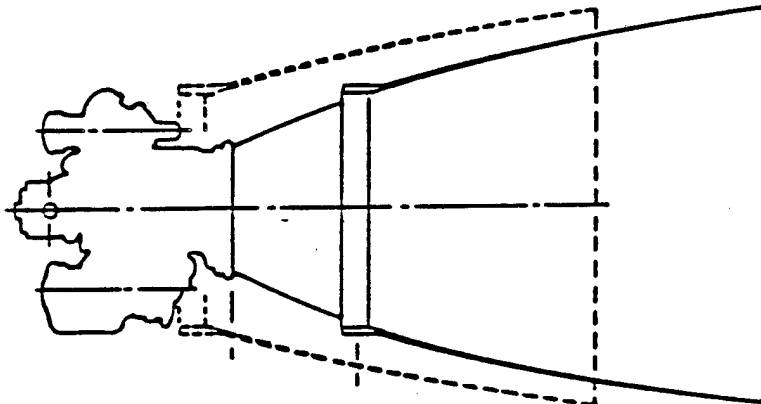

• THRUST, LBF	471608
• SEA LEVEL	534030/550355
• VACUUM	
• CHAMBER PRESSURE, PSIA	3450
• AREA RATIO (DUAL BELL NOZZLE)	50/150
• SPECIFIC IMPULSE, SEC	
• SEA LEVEL	395.4
• VACUUM	449.8/463.5
• MIXTURE RATIO	6.0
• LENGTH, INCHES	
• NOZZLE EXTENDED	219
• NOZZLE RETRACTED	139
• DIAMETER, INCHES	
• POWERHEAD	109 X 94.5
• NOZZLE EXIT	126.3
• WEIGHT, LBF	6806 *

\* REDUCED WEIGHT DUE TO USE OF COMPOSITE MATERIALS, CONTROLLER REDESIGN, ELIMINATION OF POGO SUPPRESSION, AND DELETION OF PRESSURIZATION HEAT EXCHANGERS.

BOEING PROPRIETARY

# RASV Flight Control, Secondary Power and Landing Gear Systems

D180-27669-4

284

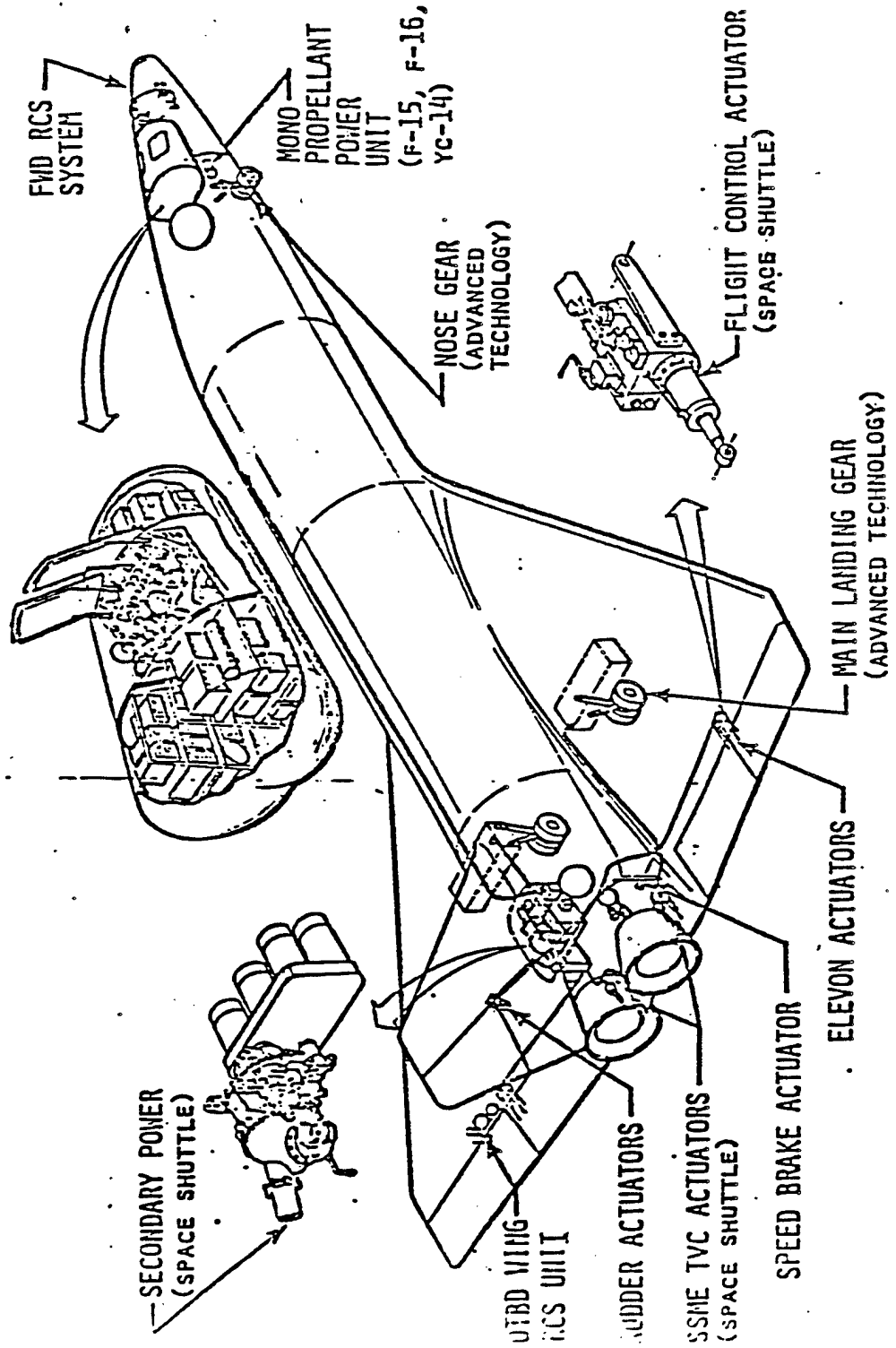

BOEING PROPRIETARY

# RASV Avionics System

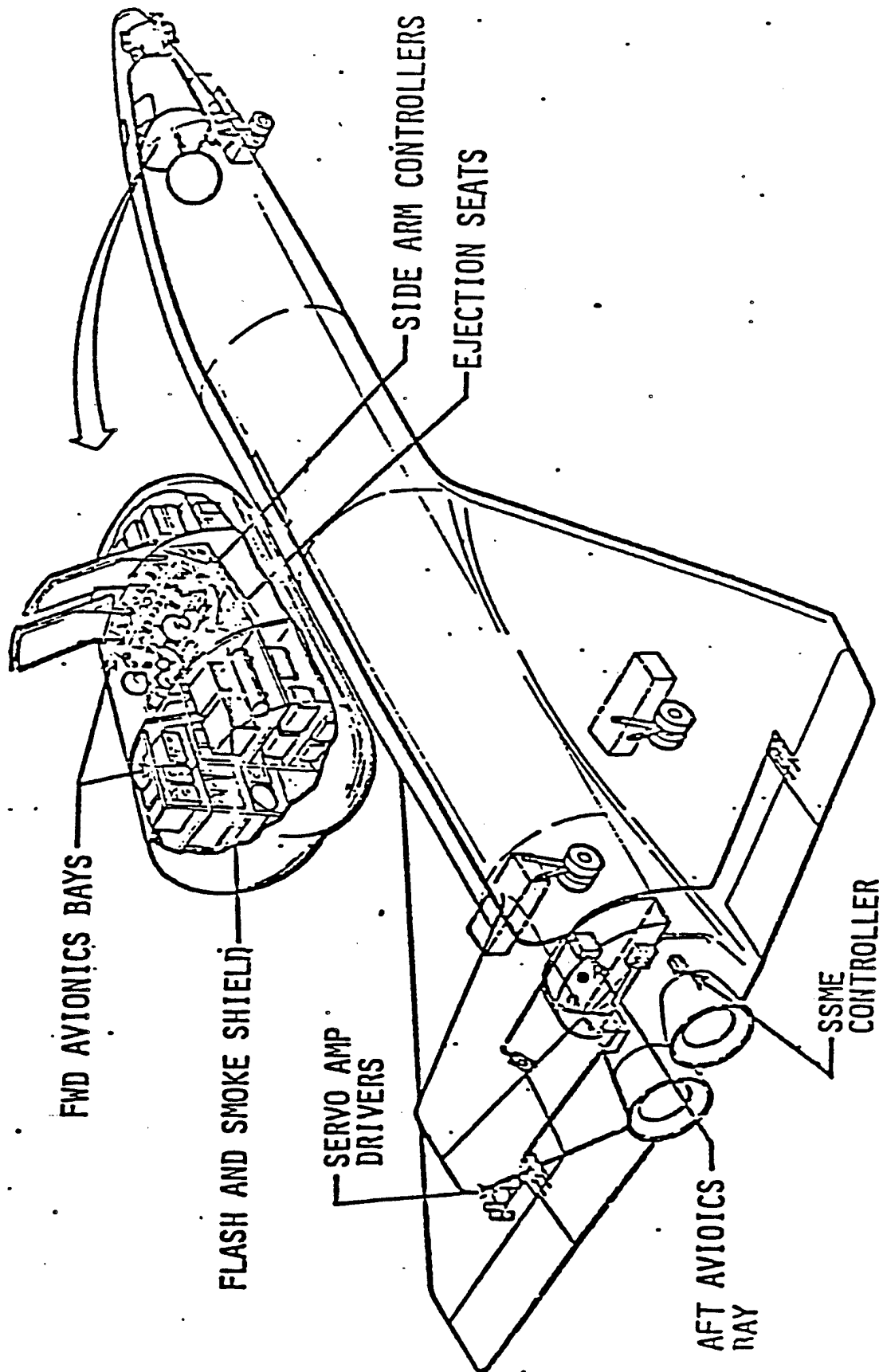



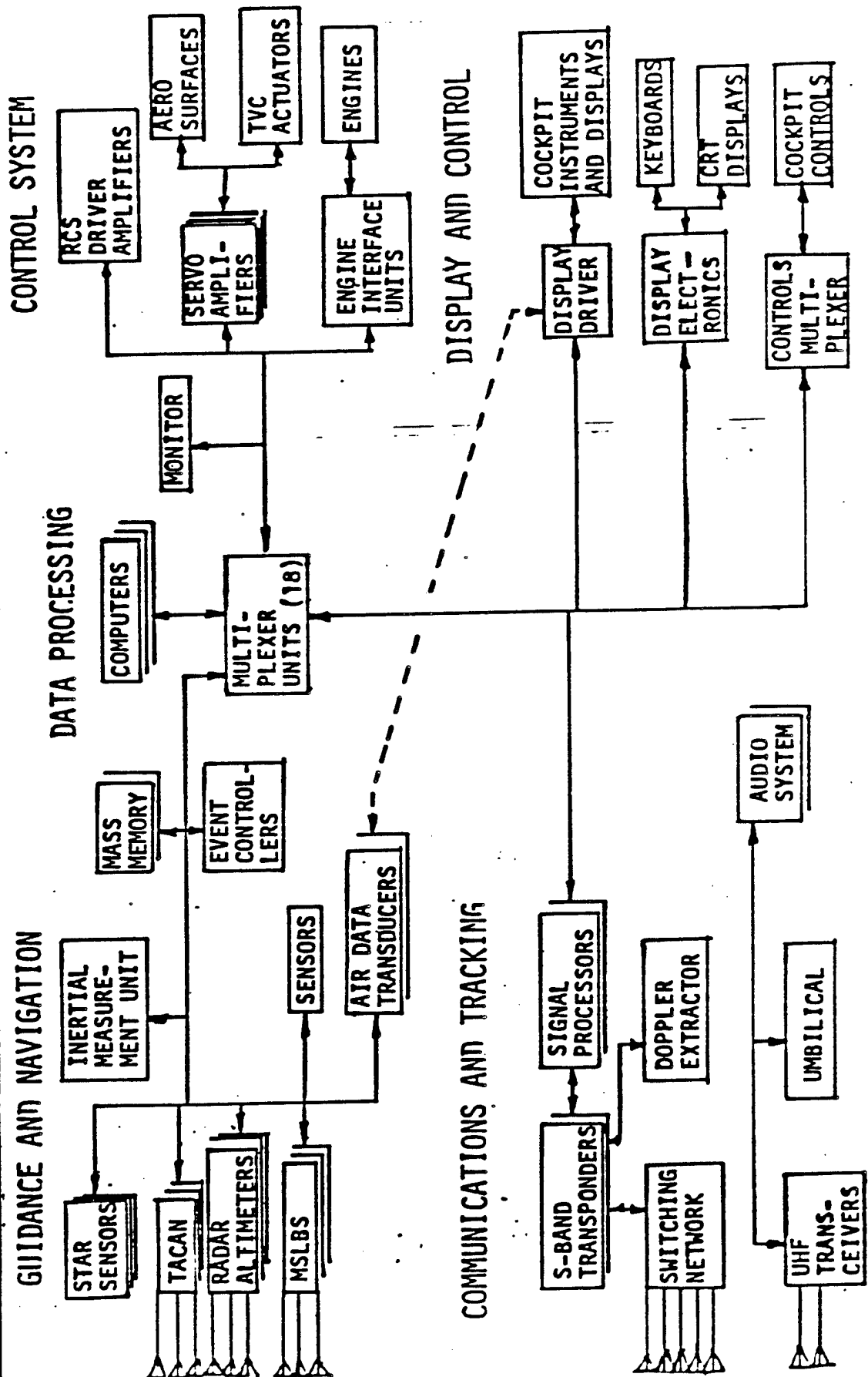

BOEING PROPRIETARY

# RASV Vehicle Weight and CG Summary

ITEM	T - 600 SEC		ENTRY		LANDING	
	WT~ LBS *	BODY ST CG	WT~ LBS *	BODY ST CG	WT~ LBS *	BODY ST CG
BODY	35,895	1,304	35,895	1,304	35,895	1,304
WINGS (2)	43,930	1,753	43,930	1,753	43,930	1,753
CREW COMP.	1,332	356	1,332	356	1,332	356
VERTICAL TAIL	2,830	2,160	2,830	2,160	2,830	2,160
TPS	1,765	1,251	1,765	1,251	1,765	1,251
SPEED BRAKE	1,236	2,079	1,236	2,079	1,236	2,079
SUBSYSTEMS	32,785	1,685	32,785	1,685	32,785	1,655
FLUIDS/PROPELLANT	13,621	1,547	5,344	1,322	2,239	1,673
PERSONNEL	477	383	477	352	477	383
PAYLOAD(NO GROWTH)	20,000	1,380	20,000	1,380	20,000	1,380
P/L CONDITION	470 *	1,380	470 *	1,380	470 *	1,380
P/L IN	154,340	1,554	146,060	1,547	142,960	1,557
CG % OF BODY		70%		69.6%		70.1%
P/L OUT	134,340	1,580	126,060	1,573	122,960	1,585
CG % OF BODY		71.2%		70.9%		71.5

△ BODY NOSE STATION 190: REF. BODY LT. = 1951  
 △ INCLUDES WEIGHTS FROM HOT STRUCTURES STUDY--FWD BODY AND RELOCATED FWD. PRES. BLK STA. 431.

\* INCLUDES 10% GROWTH

# RASV Structure/Subsystems Weights Summary

D180-27669-4  
288

## RASV STRUCTURE WEIGHTS (SUMMARY)

ITEM	WEIGHT	BODY STATION CG
BODY		
NOSE CAP	120	
OUTER SHELL (RENE)	16,729	
OUTER SHELL (TITANIUM)	6,389	
OPENING CLOSURES	990	
INNER STRUCTURE	3,289	
P/L BAY CONTAINER	2,397	
THRUST STRUCTURE (BEAM)	911	
THRUST STRUCTURE (REDISTRIBUTION)	500	
RACEMAY	502	
ENGINE HEAT SHIELD AND AFT CLOSURE	805	
	32,632	1,304
R. H. WING		
SHELL	9,549	
GRD ACCELERATOR SUPPORT	710	
LEADING EDGE	3,048	
SIDE OF BODY RIB	1,848	
AFT LO <sub>2</sub> BULKHEAD	784	
MAIN GEAR WELL AND THERMAL PROT.	948	
MAIN GEAR SUPPORT	355	
MID WING LO <sub>2</sub> BULKHEAD	440	
ELEVONS	2,287	
	19,969	1,753
L. H. WING	19,969	1,753
CREW COMPARTMENT	1,211	356
VERTICAL TAIL	2,575	2,160
THERMAL PROTECTION SYSTEM	1,605	1,442
PAYLOAD BAY CONDITIONING	470	1,377
SPEED BRAKE	1,124	2,079
	79,555	
SUBTOTAL STRUCTURE	79,555	
GROWTH (10%)	7,956	
	87,511	
TOTAL STRUCTURE	87,511	

## RASV SUBSYSTEMS WEIGHTS (SUMMARY)

ITEM	WEIGHT	BODY STATION CG
LANDING SYSTEM		
MAIN GEAR (2)	2664	1,687
NOSE GEAR	742	348
		1,395
AUXILIARY SYSTEM		
MAIN ENGINE (1153 R.T.)	932	1,559
ENGINE AND ACCESSORIES (2)	15,538	2,097
TVC (4)	14,596	2,096
	942	2,113
FEED SYSTEM	1,603	1,847
He PRESSURIZATION SYSTEM	1,238	450
REACTION CONTROL SYSTEM	775	1,200
PRIME POWER	750	2,018
	1,176	998
ELECTRICAL EQUIPMENT	740	827
DISTRIBUTION AND CONTROL	436	1,288
HYDRAULIC POWER SUPPLY	99	2,004
DISTRIBUTION AND CONTROL	664	2,024
TEMPERATURE CONTROL	166	2,000
SURFACE CONTROLS		
COCKPIT	78	352
ELEVON	910	2,038
SPEED BRAKE	229	2,042
RUDDER	267	2,194
AVIONICS		
GUIDANCE AND NAVIGATION	263	442
DATA PROCESSING & SOFTWARE	347	452
COMMUNICATION & TRACKING	194	410
DISPLAYS AND CONTROLS	520	365
INSTRUMENTATION	134	1,682
ENVIRONMENTAL CONTROL (FWD) +NH <sub>3</sub> TANK	872	359
ENVIRONMENTAL CONTROL (AFT) +NH <sub>3</sub> TANK	318	2,013
PERSONNEL PROVISIONS	467	366
SUBTOTAL SUBSYSTEMS	31,217	1,704
GROWTH (10% EXCLUDING SSHE)	1,568	1,318
TOTAL SUBSYSTEMS	32,785	1,685

△ FWD BODY INCORPORATES HOT STRUCTURE RESULTS AND MOVING FWD, PRES. BULK TO STA. 421.

△ NO GROWTH IN ENGINE WEIGHT.

### **3.3.2 Concept Analysis and Trade Studies**

RASV ENVIRONMENTAL CONTROL SYSTEM

The Environmental Control System Consists Of Active And Passive Elements With The Major Heat Loads Accommodated By Water Wall Passive Shielding. Active Elements Provide Hydraulic System Thermal Management And Crew Cab/Avionics Thermal Control. Thermal Analysis Of On-Orbit Heat Flow Results Are Shown To Illustrate The Impact Of Various Vehicle Orientation And System Configuration.

BOEING PROPRIETARY

# RASV Environmental Control System

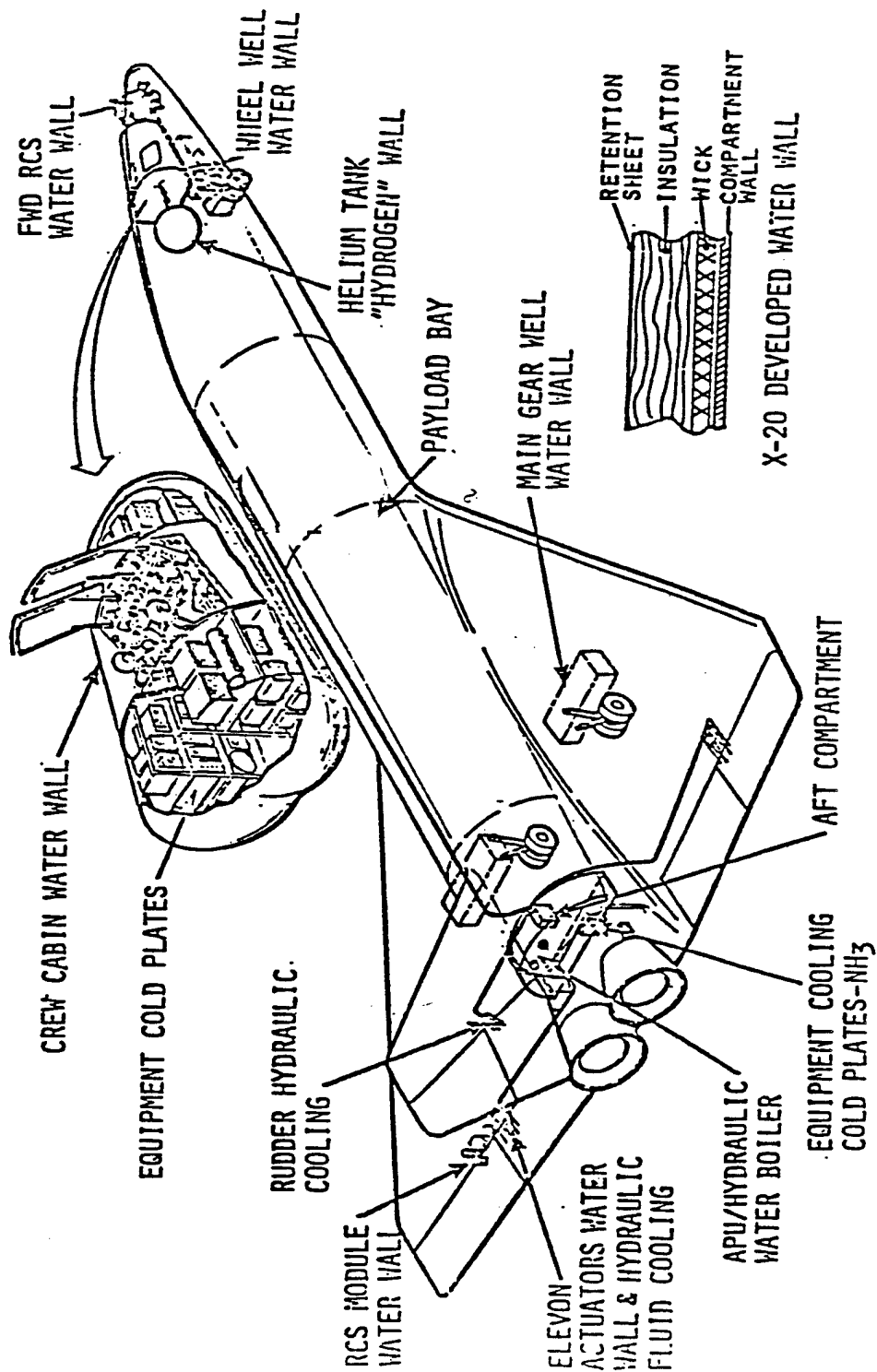

### RASV PAYLOAD PERFORMANCE ANALYSIS

The payload performance of the two SSME Rocket Powered Airplane configured for the Air Force is shown. The difference between the two lines is the weight of the orbiting maneuvering system fuel that will provide a delta velocity of 250 feet per second. This performance is based on taking off east and then doing a subsonic turn into the desired orbit inclination.

# RASV Payload Performance Analysis

- LAUNCH SITE: GRAND FORKS, N.D.
- BURN OUT WEIGHT MINUS PAYLOAD = 134,340 LB
- SSME - 115% RATED POWER

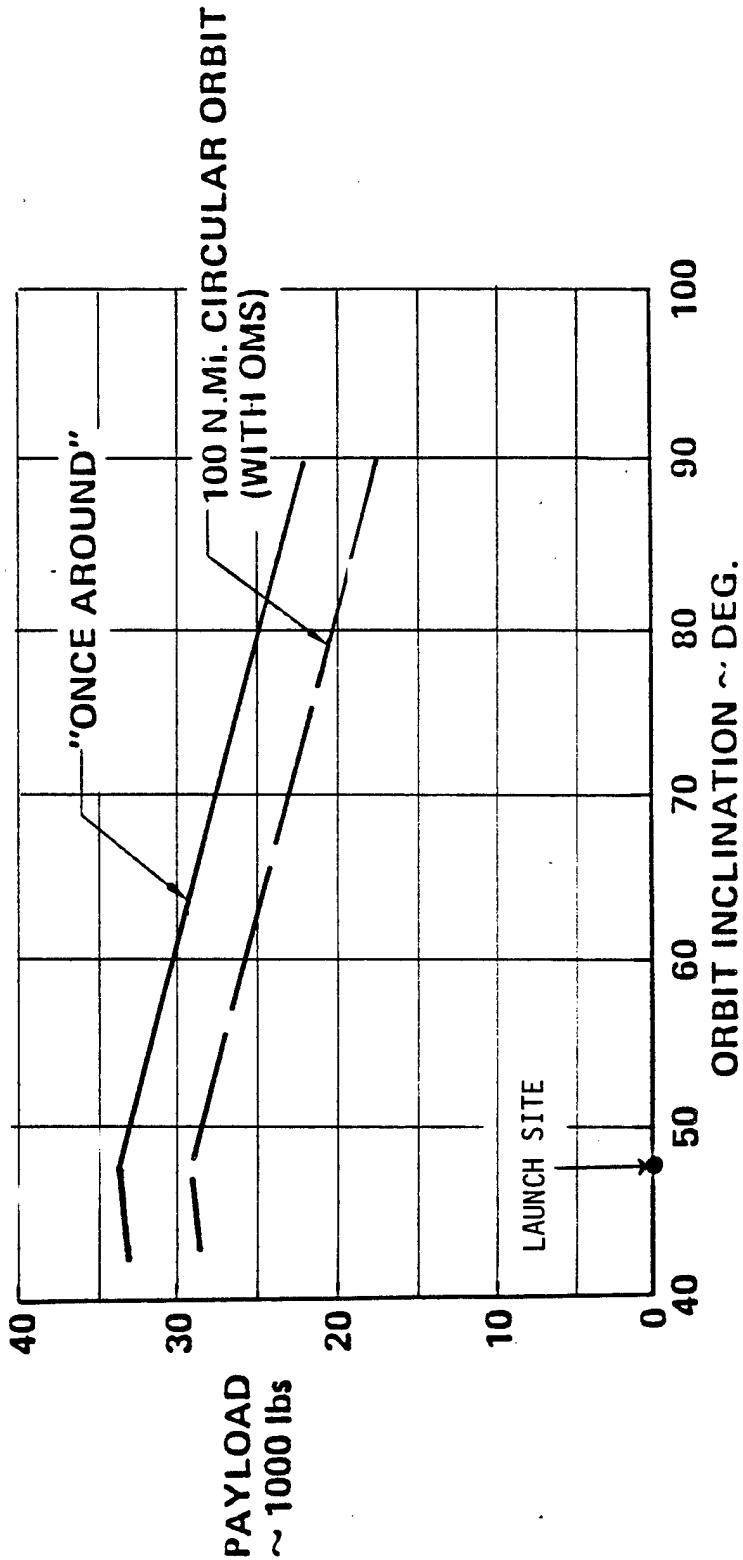

MISSIONS A THROUGH D WILL BE ADDRESSED IN DETAIL ON A FOLLOWING PAGE



## RASV PAYLOAD PERFORMANCE--TAV MISSIONS

The estimated payloads are shown for Missions A, B, C, and D defined in Battelle's memo BCD-SSS-TAV-EER-ICM 83-2. The Mission A payload was computed using the main ascent engine to fly into approximately a constant 500,000 foot orbit. The vehicle was then deorbited using an orbiting maneuvering system. The flight was ConUS to ConUS once around. As may be seen, this significantly reduces the payload capability for the normal once around flight.

The payload to a 250 n.m. orbit (Mission D) will be significantly increased using a LO<sub>2</sub>/LH<sub>2</sub> OMS. The large in orbit velocity increase required for Mission D results in the LO<sub>2</sub>/LH<sub>2</sub> system (higher ISP) being more weight efficient than the Space Shuttle OMS.

# RASV Payload Performance TAV Missions

RASV Weight--Main Engine Cut Off = 134,340 Pounds--No Payload  
 Orbiting Maneuver System (OMS)(MMH/N<sub>2</sub>O<sub>4</sub>) Weight ( $\Delta V = 250$  ft/sec)  $\approx$  5200 Pounds  
 Main Ascent Engine = SSME @ 115% R. P.

Mission (Ref. Attachment A to Battelle  
 Memo BCD-SSS-TAV-EER-ICM 83-2)

Payload (Estimated)

- A (Req's OMS for  $\Delta V \approx 100$  ft/sec  
 OMS Sys. Wt. = 3200 lbs)
- B (Req's OMS for  $\Delta V \approx 250$  ft/sec  
 OMS Sys. Wt. = 5,200 lbs)
- C (No OMS)
- D (Once Around PL  $\approx 36,700$   
 OMS Wt. Req. = 20,000 lbs  
 Docking Req's Part of  
 Payload Ref. 7)

- 20,500 Pounds  $\triangle 1$   
 (26000) "
- TBD Pounds  $\triangle 1$   
 (17,000) "
- 32,000 Pounds
- 16,000 Pounds  $\triangle 2$

- $\triangle 1$  Payload to 100 n.m. Circular Orbit with OMS Capable of 250 ft./sec.
- $\triangle 2$  A 6000 Pound Payload Increase Possible with LO<sub>2</sub>/LH<sub>2</sub> OMS

## STABILITY AND TRIM

Vehicle controllability must be established early in the concept evaluation stage. When dealing with unstable reentry vehicles, the design quickly runs into material temperature limitations and or excessive attitude control fuel weights.

The stability and trim characteristics (RASV vehicle) are shown to illustrate the controllability of the rocket airplane generic family. As may be seen, the configuration is stable at both hypersonic and subsonic flight.

# Stability and Trim

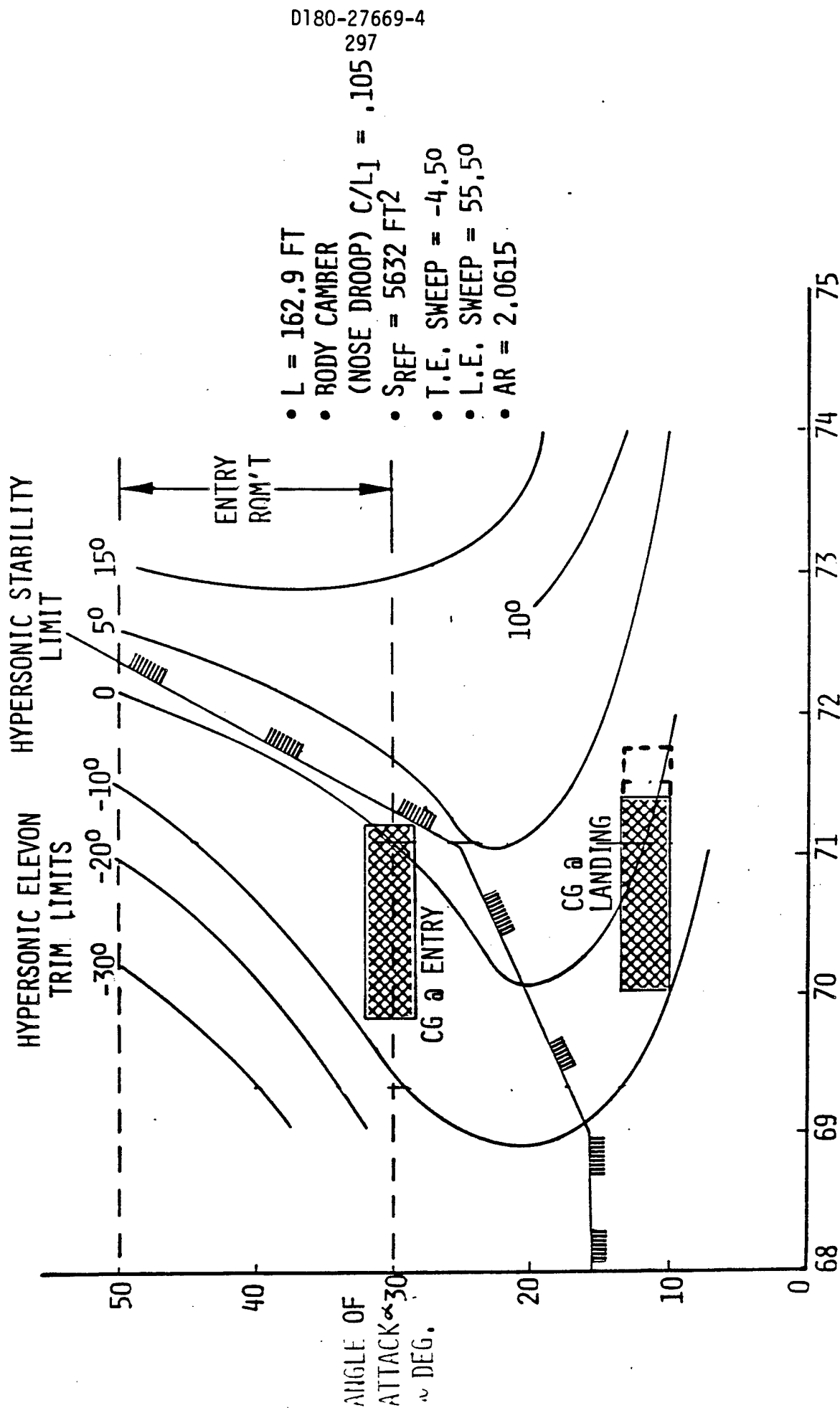

PERCENT OF BODY LENGTH (L)

## BOEING PROPRIETARY

## SUBSYSTEM REQUIREMENTS - EXTENDED SPACEFLIGHT

A series of studies were conducted to evaluate capability of the RASV for extended periods of orbital flight. The one day flight is conducted by using the same configuration as the 12-hour vehicle. This configuration is the same as the once-around system plus the addition of a 115 pound battery. The seven day and thirty day missions require the addition of three  $\text{LO}_2$ ,  $\text{LH}_2$  fuel cells. As may be noted, the system was not considered to be manned during the thirty day missions. However, this is possible in that the crew compartment has space for exercising and enhancing man's requirements. The 1603 pounds removed for the unmanned configuration include the two crew, their seats and life support system.

# SUBSYSTEM REQUIREMENTS EXTENDED SPACEFLIGHT

	Spaceflight Time			
	12 HOURS	1 DAY	7 DAYS	30 DAYS
▲ WEIGHT SUMMARY				
SECONDARY POWER	199	580	917	2,992
RCS - ATTITUDE CONTROL	15.7	31.3	219.1	939
ORBIT MAINTENANCE	8	16	112	480
ECS	25	50	350	--
UNMANNED	--	--	--	--
UNMANNED	-1,603	-1,603	-1,603	-1,603
TOTAL	248	677.3	1600	2808
	-1,380	-976	-355	

▲ ADDITIONAL WEIGHT FOR NH<sub>3</sub> BOILER AND STRIP HEATERS UNKNOWN - IF REQUIRED

## RASV - ABORT (ENGINE-OUT) AND RETURN TO LAUNCH SITE

The ability to abort after losing an engine on the take off run is illustrated. The illustration shows the abort trajectory for the RASV. This study was run for the Air Force in the RASV operations analysis study. The abort characteristics of these systems support the acceptance of inland siting.

The approach used to assess take-off abort was to do a refuse take off up to 300 feet/second after which if an engine failed proceed with the take off, burn off the fuel, and land at the take-off site. The flight trajectories developed for the RASV system would in general be applicable to both larger and smaller vehicles. The important constraint is to keep the vehicle within limiting Mach Number and altitude relationships and maintain controllability.

# RASV - ABORT (ENGINE-OUT) AND RETURN-TO-LAUNCH-SITE

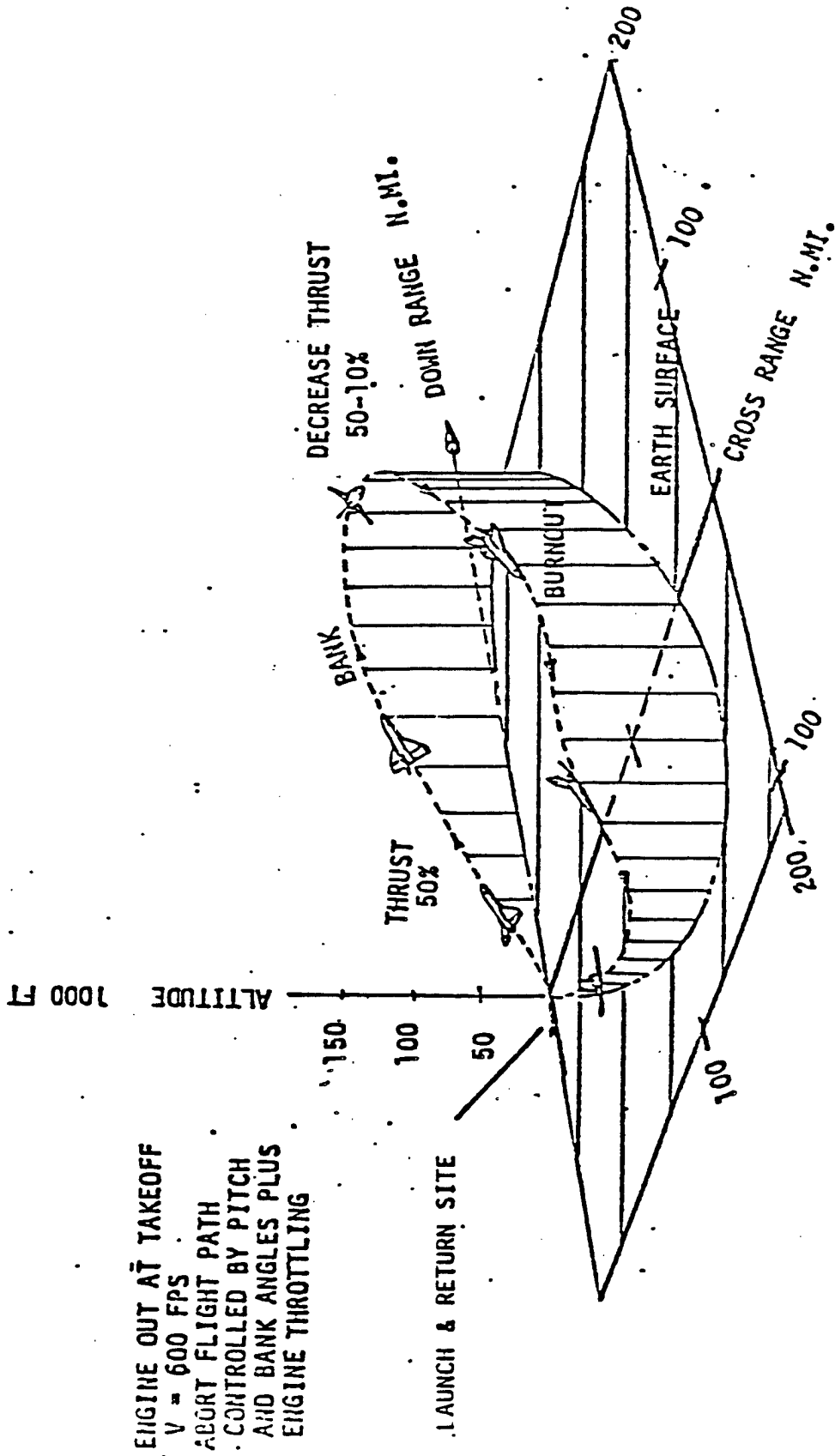



**BOEING PROPRIETARY****RASV GROUND OPERATION--MAIN BASE**

The RASV can be operated from any airfield with runways of 12,800 feet in length. The plan would be to use fueling revetment with either a direct easterly runway or short taxiways leading to an easterly directed runway. The maintenance facilities are similar to those existing at a typical Air Force base.

Landing runways and facilities are the ones existing at the airfield. No new or unique landing facilities are required.

LH<sub>2</sub> and LO<sub>2</sub> would either be stored at the field or trucked in during fueling operations. At permanent bases, cryogenic storage and reliquification facilities would be installed.

BOEING PROPRIETARY

# RASV Ground Operations Main Base

D18Q-27669-4  
303

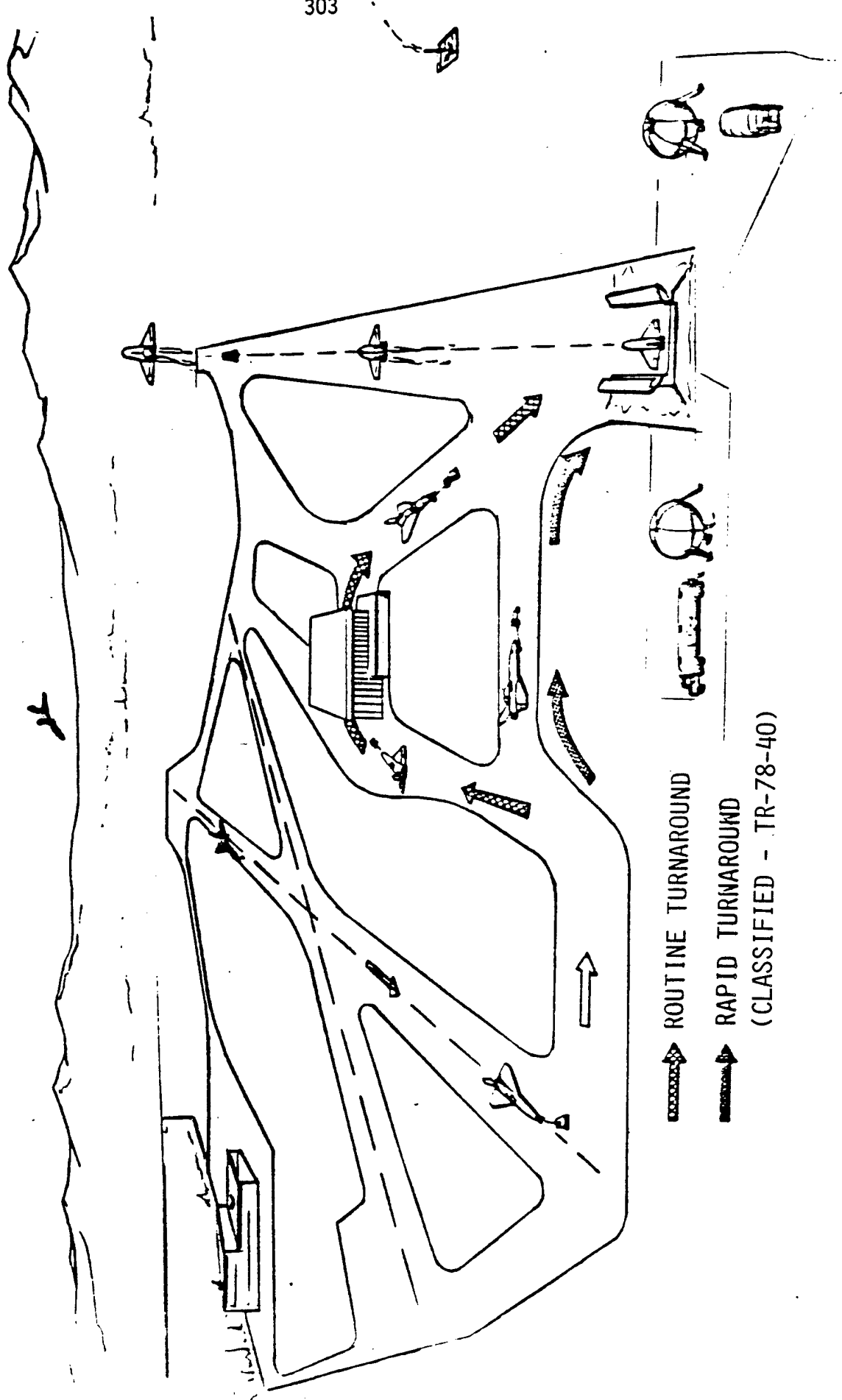

➤ ROUTINE TURNAROUND

➡ RAPID TURNAROUND

(CLASSIFIED - TR-78-40)

## RASV VEHICLE MATE OPERATIONS

A primary system design objective was to perform all ground handling with the vehicle on its own landing gear and by the use of a tow truck. As shown, the air vehicle may be backed up four foot ramps onto the ground accelerator (ground sled). After moving the ground accelerator supports up in contact with the vehicle, the landing gear is retracted with the aid of ground support equipment. The vehicle and ground accelerator may be towed as a system assembly.

The ground accelerator contains all of the propellents consumed by the rocket engines on the ground accelerator. There is no propellant transferred between the ground accelerator and the RASV.

The ground accelerator contains approximately 9,000 pounds of liquid hydrogen and 56,000 pounds of liquid oxygen.

# RASV Vehicle Mate Operations

D180-27669-4  
305

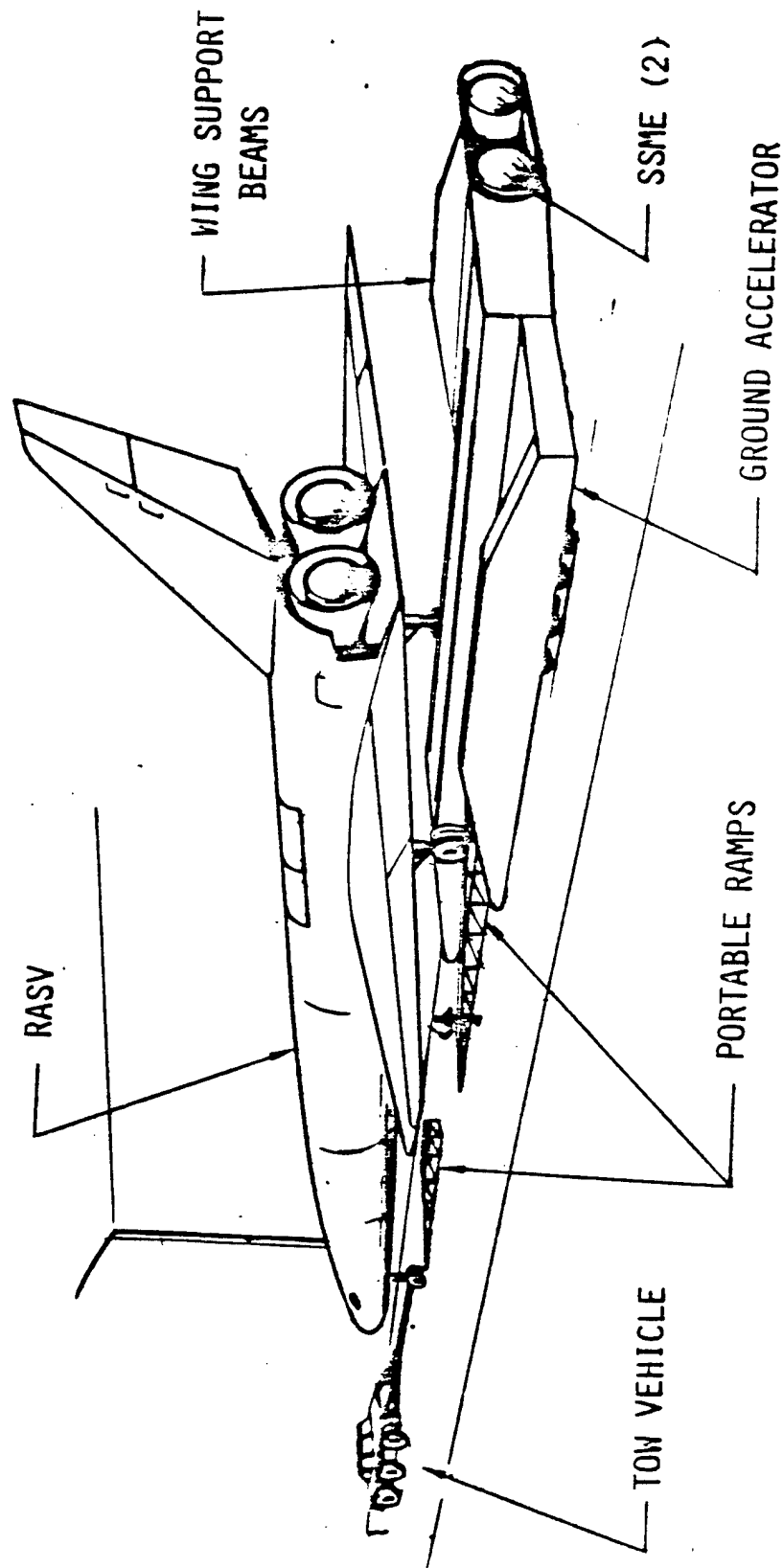

BOEING PROPRIETARY

RASV TAKEOFF PROFILE

Time-dependent analysis of the RASV takeoff ground run provided the shown performance characteristics. Wind tunnel data from a similar configuration were used in the analysis. As shown, the takeoff is accomplished in approximately 5800 feet with the ground-support vehicle stopping in 7000 additional feet. The 7000-ft stopping distance can be varied somewhat by use of various drag and braking devices.

Similar analyses were conducted for a case of a 40-kn crosswind. The system maintained heading and down forces on all running gear for this case.

BOEING PROPRIETARY

# RASV Takeoff Profile

(1) BRAKE RELEASE (TIME = 0)

THRUST LEVELS

AIR VEHICLE: 100-50%

GRD VEHICLE: 100%

$\alpha = 8^\circ$

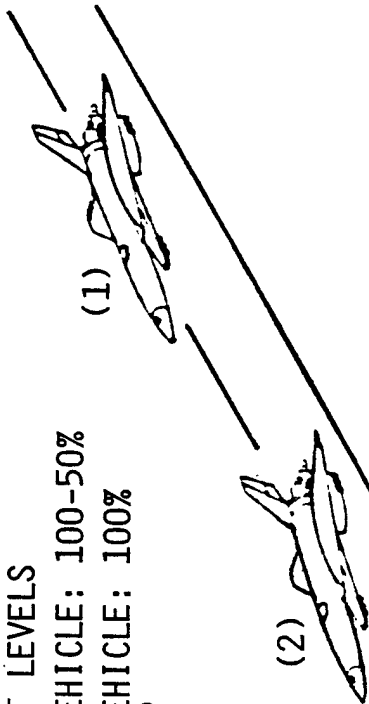

(3) SEPARATION (TIME = 21 SEC)

DISTANCE = 5832 FT

SPEED = 552 FPS



(5) GRD VEHICLE STOP

DISTANCE = 12,800 FT

(2) THRUST CHANGE (TIME = 16.6 SEC)

AIR VEHICLE: 100%

GRD VEHICLE: 50%

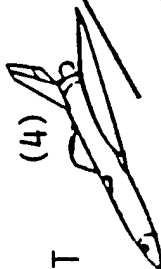

(4) GRD/AIR VEHICLE CLEARANCE

HORIZONTAL DISTANCE = 37 FT

VERTICAL DISTANCE = 23 FT

MAX ELEVON = 5.3° DOWN

MAX ENGINE GIMBAL = 1.8° DOWN

(5)



AIR FERRY CONFIGURATION  
JET ENGINE -- GROUND SUPPORT VEHICLE

Under current evaluation is the concept of replacing the rocket engines with jet engines in the take off support vehicle. With this configuration, the RASV can accomplish self dispersal flight to ranges of around seven hundred miles. Take off and landing runway required lengths are less than 5,000 feet. The jet pod provides the running gear and support required for take off to spaceflight. For spaceflight, the jet pod remains on the ground.

This self dispersal flight is feasible due to the low subsonic wing loading on the unfueled air vehicle (i.e. 26 pounds/foot<sup>2</sup>). Use of the jet engine pod will reduce spaceflight payload approximately 1400 pounds and increase the take off roll approximately 1500 feet.

Using the jet pod permits either predispersal or dispersal on demand to many airfields, lake beds, highways, etc. At these sites, the vehicle can be serviced by special over-the-highway equipment. The jet pod is to be configured such that it can be recovered/delivered by the C-5A.

# Air Ferry Configuration

## Jet Engines--Ground Support Vehicle

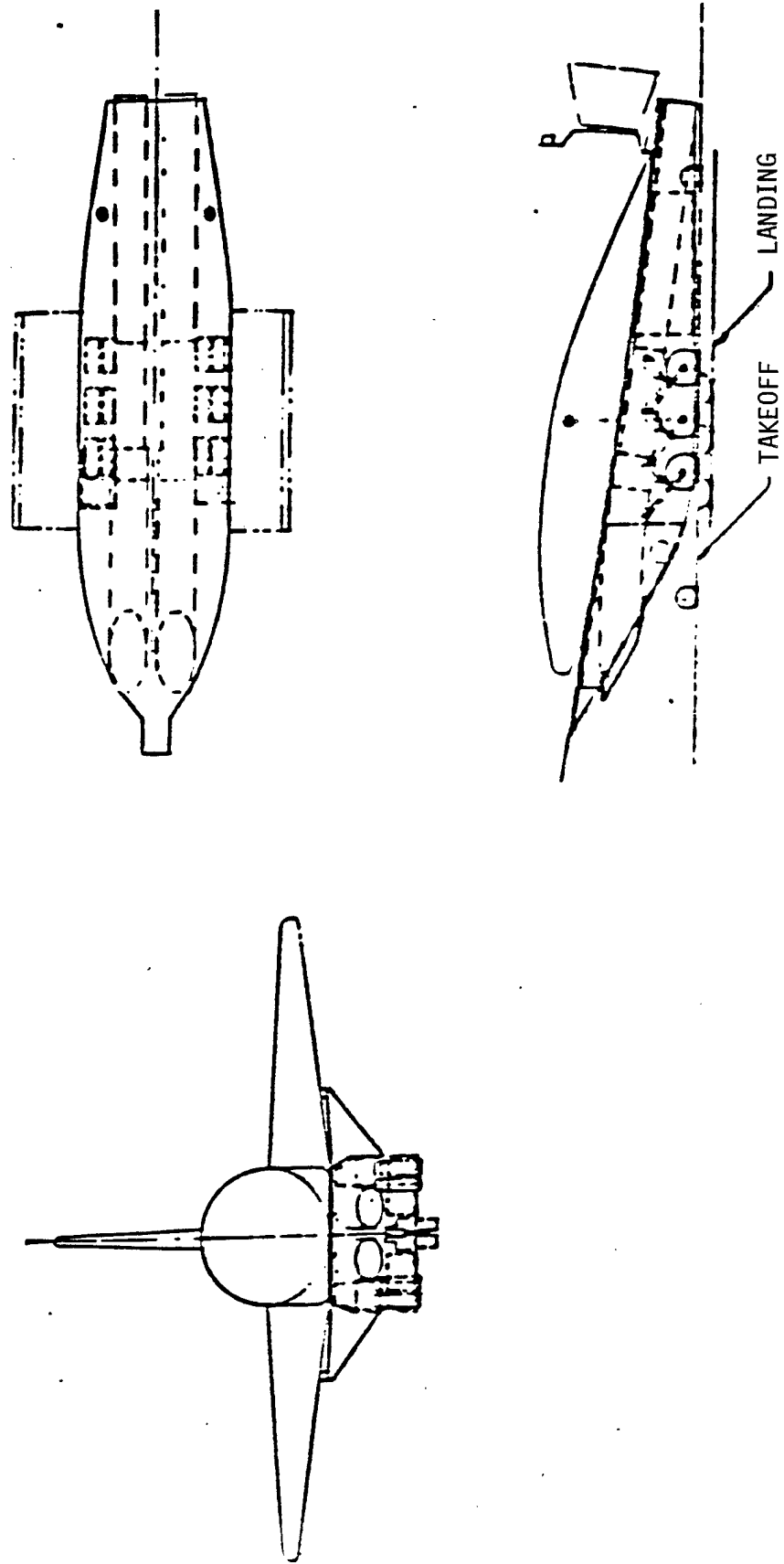



# Jet Pod Concept Ground Support Takeoff Vehicle (GSTV)

- Used for:
  - Spaceflight GSTV
  - In Atmosphere Flight (Provides Propulsion)
- Extends Spaceflight Air Vehicle Take Off Roll < 2000 Feet
- Air Ferry Flight Vehicle = 700 Miles
- Spaceflight RASV Payload Penalty = 1400 Lbs.

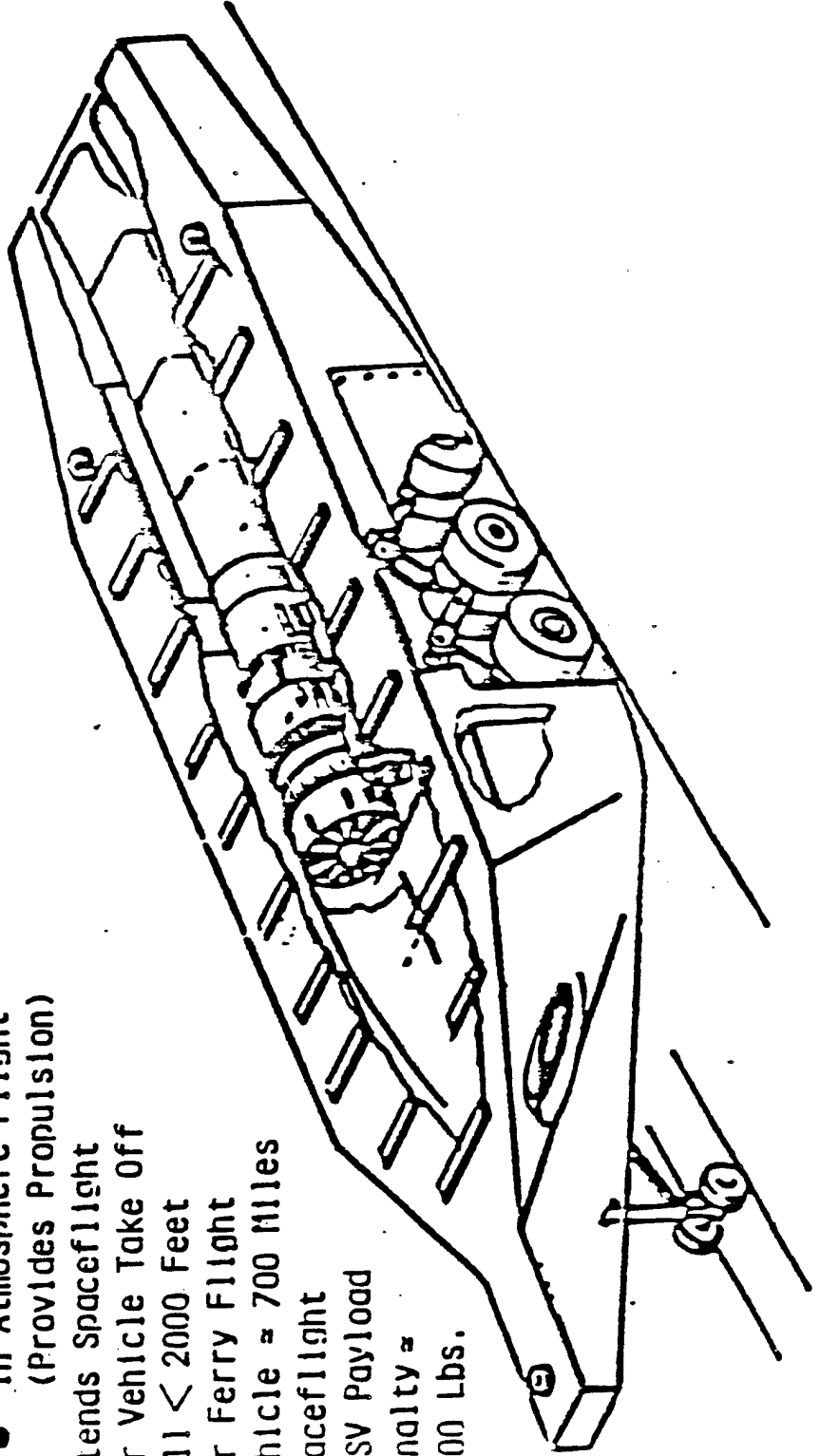

BOEING PROPRIETARY

# Fueling Remote Site

D180-27669-4

311

3

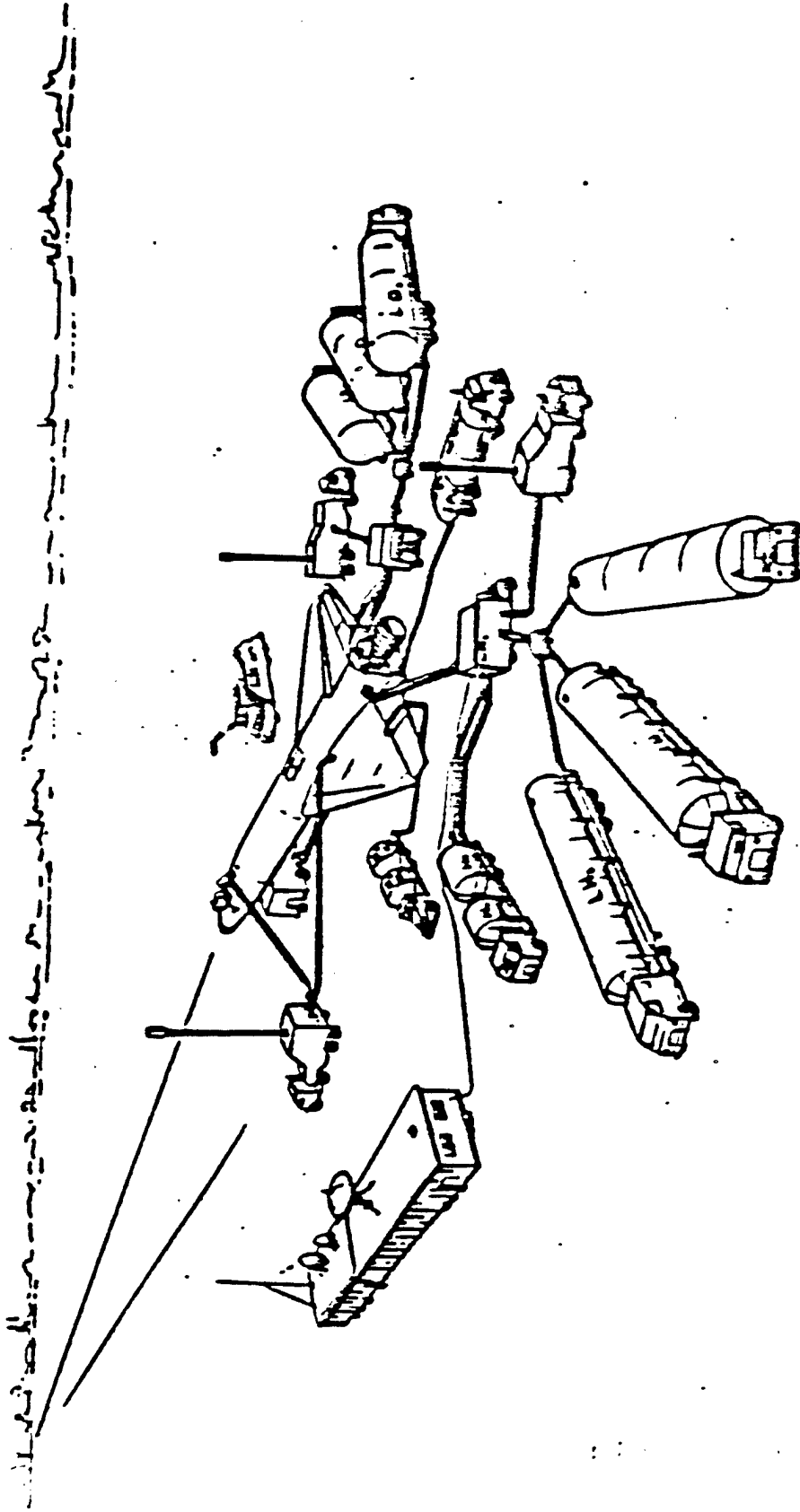

**BOEING PROPRIETARY****FERRY MISSION - RETURN RASV TO BASE**

Earth transportation of the Rocket Aircraft up through the size of the RASV's can be accomplished using the Boeing 747. Range of the shown combinations permits delivery of the RASV from any place in the world back to ConUS. This concept has been well demonstrated by the carrying of the Space Shuttle on the 747.

Loading of the RASV can be accomplished by over-the-highway cranes.

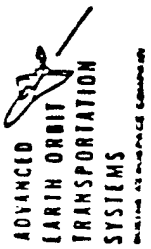

BOEING PROPRIETARY

# FERRY MISSION RETURN RASV TO BASE

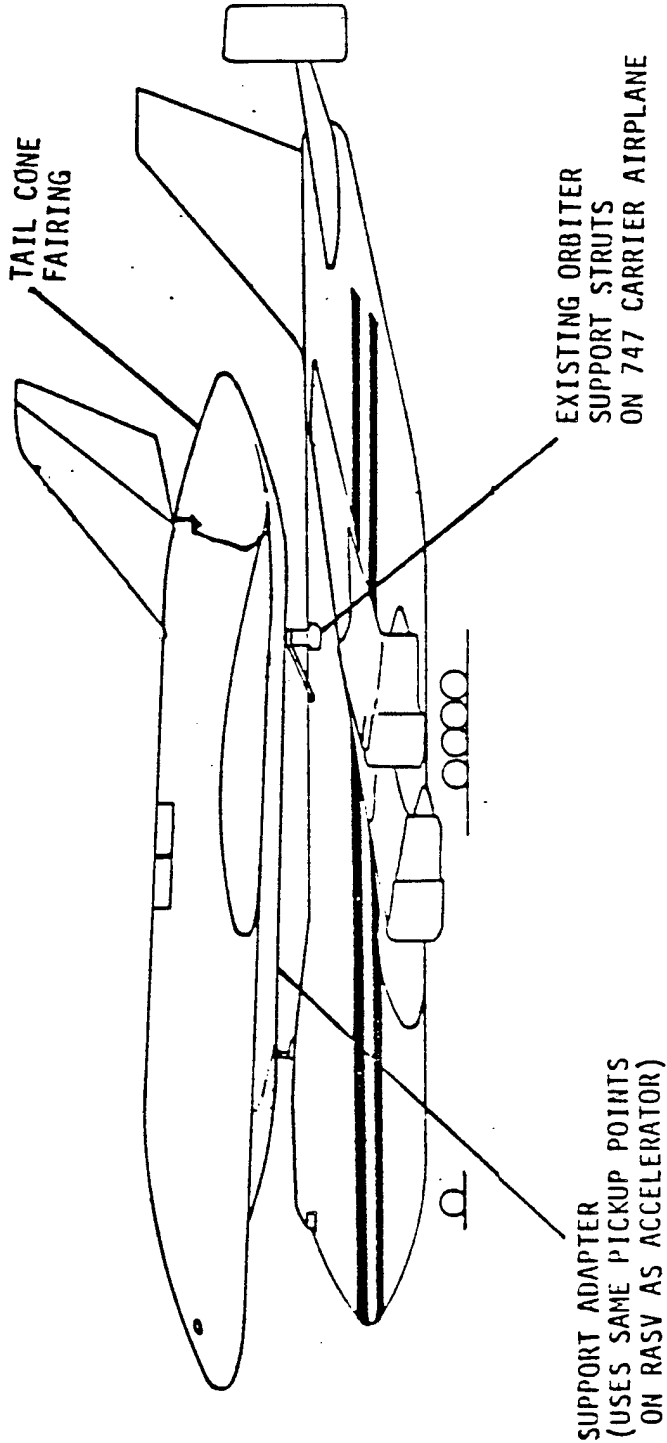

## BOEING PROPRIETARY

## RASV OPERATIONAL COST/FLIGHT

An Air Force sponsored study established and documented operational costs for the RASV. The engine costs were supplied by Rocketdyne and fully recognize refurbishment and replacement costs. Hydrogen costs are based on \$1.10 per pound. Costs were developed using functional time lines and historical data for rocket and aircraft systems. Similar data have been developed for the four SSME concepts. These data serve as a baseline from which operating cost for smaller vehicle may be factored.

# RASV OPERATIONAL COST FLIGHT DOLLARS IN THOUSANDS

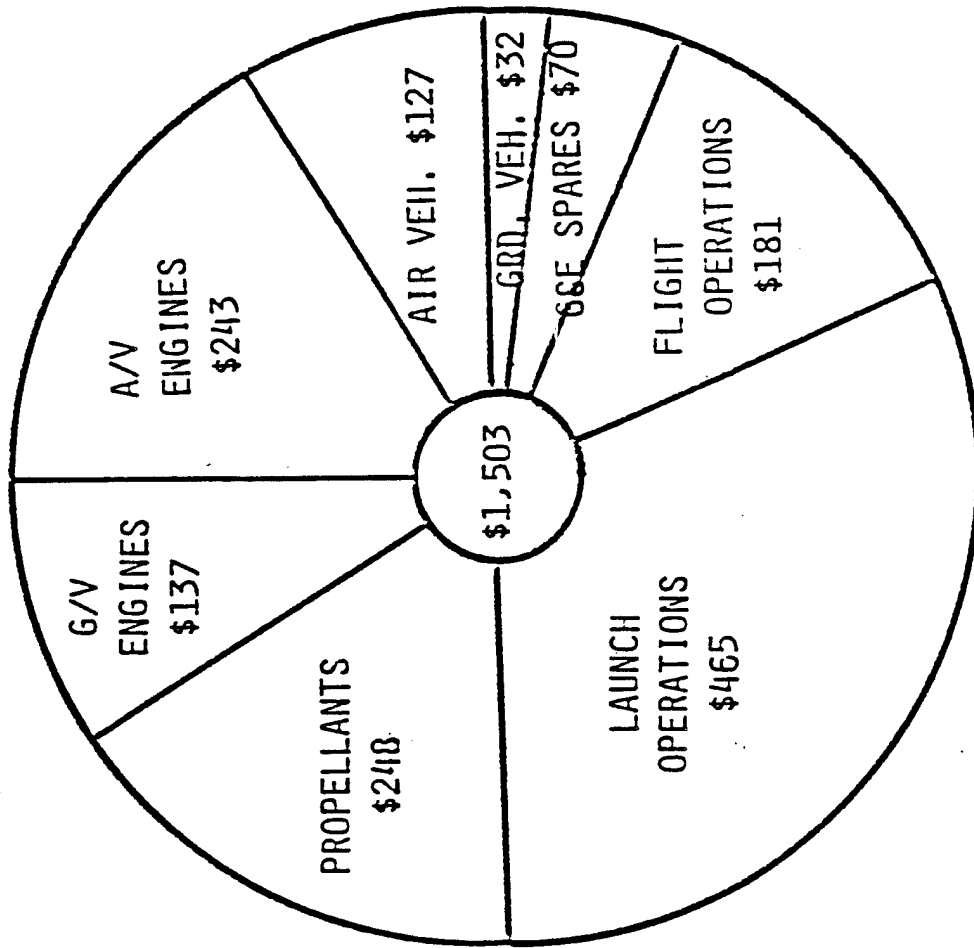

BASED ON 25 FLIGHTS/YEAR  
DOLLARS 1983.

FUELED GROUND HOLD COST  
\$1500/110UR

BOEING PROPRIETARY  
ROCKET POWERED AIRCRAFT DEVELOPMENT  
REUSEABLE AERODYNAMIC SPACE VEHICLE

A schedule for the RASV concept definition, validation, development and flight test was developed in support of Air Force contracted studies. The scheduling was supported by personnel with experience on large Military Bombers, X-20 and the Supersonic Transport. Development and validation programs for each major subsystem were defined and scheduled.

The schedule below is based on the position of having built development hardware prior to initiating design in the following phase.

# ROCKET POWERED AIRCRAFT DEVELOPMENT

## REUSEABLE AERODYNAMIC SPACE VEHICLE

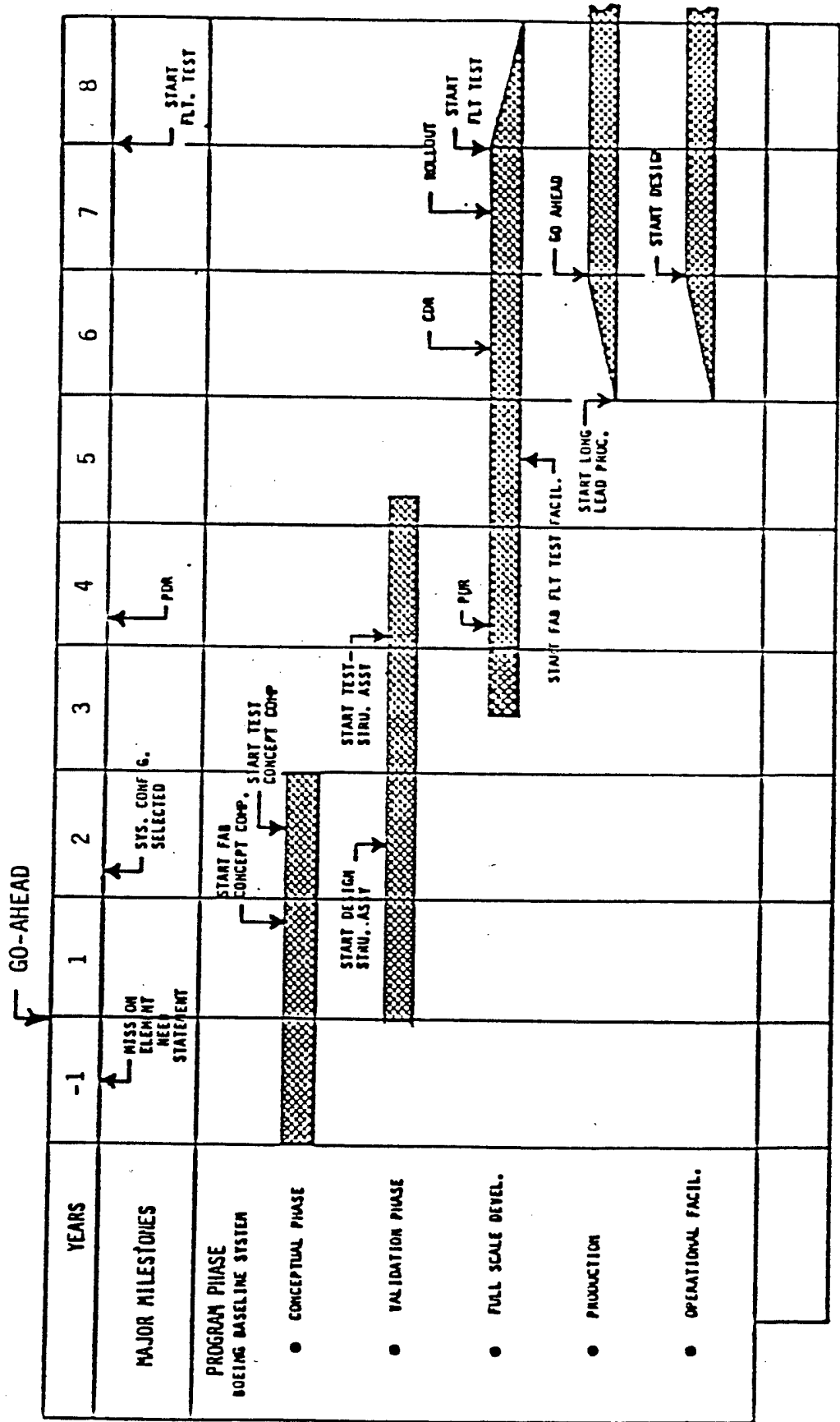



Logistics And Support

- Main Base--Ref. SAMSO TR-78-40, Vol. I
- Wheeled Ground Take Off Support Vehicle
- Rapid Turnaround and Launch - (TR-78-40, Vol. III, SECRET)
- Remote Site
- Jet Engine Ground Take Off Support Vehicle
- RASV LO<sub>2</sub> and LH<sub>2</sub> Tank Servicing--Ref. SAMSO TR-78-40, Vol. I
- Chilli Down
- Tank Fill
- Boll Off Rates--Take Off Hold

THIS PAGE INTENTIONALLY LEFT BLANK

### **3.3.3 Cost Analysis**

## BOEING PROPRIETARY

System Cost Analysis

System costs are presented for the Reuseable Aerodynamic Space Vehicle System (B-3) as defined in Reference 2 and supplemented by results of a Operations Analysis (Reference 7). The costs cover the development, fabrication, test and operation of the air vehicle, ground vehicle, air carry vehicle and ground facilities. No payload or payload integration costs are included.

Program costs were developed using a schedule of activities as presented in the Program Schedule. The plan includes approximately three years of technology development with fabrication of structural assemblies prior to initiating the Validation Phase. The costs associated with this early development have not been included. Costs are presented from start of Validation (ATP) throughout the delivery of two flight test vehicles and four production air vehicles, including base implementation and operations. It is assumed that one of the flight vehicles will be assigned to operational status. Additional production vehicles are costed using an eighty-five percent learning curve.

The schedule provides for the building of a static test air vehicle, two flight test air vehicles and a flight test take off support vehicle during full scale development. Also, included in this phase is the procurement and modification of a 747 airplane for Earth logistics, and building and operating a flight test facility. The operation of the system is based on 100 flights per year out of 4 bases equipped with five air vehicles and two take off support vehicles.

Work Breakdown Structure

A Contractor Work Breakdown Structure (WBS) Index and Dictionary for the Reuseable Aerodynamic Space Vehicle was developed. The WBS provides subordinate elements for estimating costs. The WBS builds subordinate tasks to either deliverable hardware, system tests, or systems integrated operational functions at level 2. All costs incurred to complete the level 2 tasks are collected against that element subordinate task (elements).

Cost Methodology

Costing of the RASV system was accomplished using two methods, with the objective of obtaining as much validity in the costs as possible within the limitation of contracted effort and status of the design definitions. The two methods consisted of (1) utilization of a Boeing cost model that uses parametric data to arrive at major systems element program costs, and (2) a "bottoms up" cost developed using the Boeing Supersonic Transport Work Breakdown Level 4 actual development costs. The Development and Production ground rules and assumptions are presented on the following page.

## BOEING PROPRIETARY

Development and Production Costs

## RASV Air Vehicle and Ground Vehicle

The RASV Air Vehicle Development and Production Cost "bottom-up" estimate uses as a guide the actual accrued man hours and material costs for the supersonic transport development. These costs had been accrued at the SST WBS level 4 equivalent and thus provide a detailed base to develop RASV development manhours. The rationale utilized in ratioing manhours between the SST and the RASV together with the task to be performed and the resulting costs was defined for each RASV Work Breakdown Structural level 3 element. The first production unit is shown for information purposes only and is used in pricing the second flight test article. No production learning was used for the first production unit. A 85% learning curve was used for subsequent production units. Presented is a further breakdown of the RASV air vehicle systems test and evaluation WBS element. This chart defines the major sub-elements of this task. This element includes all air vehicle major assembly tests including preparation (instrumentation) for system flight tests. A boiler plate air vehicle is included in this task. This unit will be used in initial check out of the ground accelerator operations and the air carry vehicle. All testing such as wind tunnel, structural allowables, material and processes development, etc. are contained under the system engineering program element. Subsystem development and/or qualification testing such as that required for the auxiliary power units, etc. is contained within the hardware WBS element.

# Development/Production General Ground Rules and Assumptions

- 0 COST IN CONSTANT FY 83 DOLLARS
- 0 ESTIMATES BASED ON MANHOURS EFFORT AND CONVERTED USING CURRENT BOEING DIRECT & INDIRECT LABOR AND MATERIAL RATES AND FACTORS ~ SST WBS BASIS
- 0 VEHICLE QUANTITIES
  - STRUCTURAL TEST ARTICLE
  - 1/5 SCALE TEST MODEL (FLIGHT & GROUND VEHICLE)
  - 1 FLIGHT TEST GROUND VEHICLE + REFURBISHMENT SPARES (1 INCLUDED IN DDT&E)
  - 2 FLIGHT TEST FLIGHT VEHICLES + REFURBISHMENT SPARES (1 INCLUDED IN DDT&E)
  - 4 PRODUCTION FLIGHT VEHICLES
  - 1 PRODUCTION GROUND VEHICLE
  - 2 SETS OF SUPPORT EQUIPMENT
- 0 PARTIAL SITE ACTIVATION OF EDWARDS TEST RANGE FOR FLIGHT TEST PROGRAM
- 0 PROGRAM MANAGEMENT FOR CONTRACTORS AND GOVERNMENT SUPPORT AT 9% (A.F. SD CONCURRENCE)

# Cost Summary RASV Air Vehicle

D180-27669-4

324

1983 DOLLARS

WBS ELEMENT	DDT&E (\$1000)	1st PROD UNIT (\$1000)	PROD (4 UNITS)	TOTAL PROGRAM
AIR VEHICLE(S)	(1,257,220)	(400,980)	1,331,600	
INTEGRATION & ASSY	94,380	43,200		
AIRFRAME MODULE	784,030	247,800		
PROPULSION MODULE	112,140	46,300		
ORBIT MANEUVERING SYS	14,500	7,500		
SECONDARY POWER GEN	58,700	5,400		
AVIONICS SYSTEM	90,470	23,000		
LANDING GEAR SYSTEM	20,210	9,000		
FLIGHT CONTROL SYSTEM	82,800	18,900		
AUXILIARY SYSTEM	43,030	11,200	36,800	
TRAINING	5,400	3,300	4,900	
SYSTEM TEST & EVALUATION (INCL FIRST ART. SPARES)	915,600			
SYSTEM PROJECT MANAGEMENT				
SYSTEMS ENGINEERING	591,364	16,300	24,300	
PROJECT MANAGEMENT	160,900	15,200	40,500	
DATA	23,200	1,600	3,240	
GOVERNMENT MANAGEMENT	265,350	40,372	130,000	
TOTAL	3,213,630	489,000	1,571,000	5,273,600

 INCLUDES FIRST PROD UNIT 85% LEARNING    
  INCLUDES ONE FLIGHT UNIT

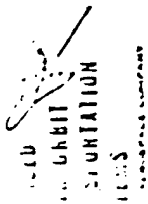

BOEING PROPRIETARY

# Cost Summary RASV Air Vehicle

D180-27669-4  
325

1983 DOLLARS

WBS ELEMENT	DDT&E (\$1000)	1st PROD UNIT (\$1000)	PROD (4 UNITS)	TOTAL PROGRAM
SYSTEM TEST & EVALUATION				
RASV SEGMENT TESTS				
MAJOR STRUCT COMP	182,560			
PROPULSION TEST COMP	81,500			
FLIGHT CONTROL	67,270			
COMMUN/NAV/RADAR	31,800			
RASV SYSTEM TEST				
STATIC TEST	367,900			
1/5 SCALE GRD ACCEL TEST	17,800			
FIRST FLT ART TEST SUPT	6,520			
BOILER PLATE RASV	22,820			
FIRST FLT ART SPARES	57,050			
MOCKUPS	37,000			
TEST & EVALUATION SUPT	18,908			
TEST FACILITIES	24,450			
TOTAL	915,600			



## TAKE OFF SUPPORT VEHICLE

Presented is a cost summary for the take off support vehicle. These costs were developed using estimated values based on experience in engineering and building similar subsystems. As there was no similar system to relate to, the cost model was also considered an appropriate tool to develop comparative system costs. In this costing no production learning was considered for the first production unit. However, for additional units an 85% learning curve would be used.

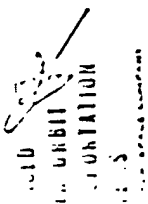

BOEING PROPRIETARY

# Cost Summary (Cont.) RASV Takeoff Support Vehicle

D180-27669-4  
327

1983 DOLLARS

WBS ELEMENT	DDT&E (\$1000)	1st PROD UNIT (\$1000)	PROD (4 UNITS)	TOTAL PROGRAM
GROUND VEHICLE				
INTEGRATION & ASSY	18,230	10,100		
AIRFRAME	104,900	29,400		
PROPULSION UNIT	59,600	43,400		
SECONDARY POWER GEN	18,800	4,400		
AVIONICS	29,800	11,800		
AUXILIARY SYS & EQUIP	54,300	22,030		
ENVIRONMENT CONTROL	4,700	680		
SYSTEM TEST & EVAL	125,400			
SYSTEM ENG/PROJ MGT	33,800	2,300		
SYSTEM ENG	23,200	2,300		
PROJECT MGT				
DATA	3,240	200		
TRAINING	2,100	200		
GOVERNMENT MANAGEMENT	43,000	11,400		
TOTAL	521,000	138,200		

INCLUDES FIRST PROD UNIT 85% LEARNING INCLUDES ONE FLIGHT UNIT

### System Support Equipment

Costs for the system support equipment are shown. The support equipment cost includes the design, fabrication testing and hardware programs required to support the ground operations for manufacturing, transportation, assembly, launch, site and depot maintenance. Discrete ground support equipment which was particularly peculiar or unique to the RASV system such as the TOW vehicle was estimated on an individual basis by comparison of design requirements with similar machines or equipment. These estimates were then added to outputs from the cost model which were developed from historical support equipment costs.

# Cost Summary Support Equipment

D180-27669-4

329

1983 DOLLARS

WBS ELEMENT	DDT&E (\$1000)	1st PROD UNIT (\$1000)	PROD (4 UNITS)	TOTAL PROGRAM
LAUNCH & LANDING SITE				
INTEGRATION & ASSEMBLY				
ELECTRICAL				
MECHANICAL				
PROPULSION	300,000	113,400		
COMPUTER PROGRAMS				
COMMON SUPPORT EQUIPMENT				
OTHER				
ALTERNATE/CONTINGENCY LANDING DEPOT				
FACTORY				
S.E. MAINTENANCE				
S.E. SPARES				
OTHER SUPPORT EQUIPMENT				
GOVERNMENT MANAGEMENT	27,000	10,200		
TOTAL	327,000	123,600		

### Air Carry Vehicle

The "air carry vehicle" cost summary is shown. The air carry vehicle program consists of tasks and hardware to modify a used Boeing 747 aircraft, complete flight testing to qualify the system to transport the RASV air vehicle and all ground support equipment. The costs for this program were obtained using as a basis the cost incurred for the Space Shuttle orbiter carry 747 modification program. The program is for one used 747, two tail cones and one permanent air vehicle loading facility.

# Cost Summary Air Carry Vehicle

1983 DOLLARS

WBS ELEMENT	DDT&E (\$1000) <input type="checkbox"/>	1st PROD UNIT (\$1000)	PROD (4 UNITS) <input type="checkbox"/>	TOTAL PROGRAM
AIR CARRY VEHICLE				
747 AIRCRAFT (USED)	32,400			
747 MODIFICATION	37,300			
CARRIER ADAPTER	3,240			
RASV TAIL CONE	11,340			
PROG. SYSTEM ENG/MGT	7,290			
FLIGHT TEST	8,100			
LOADING FIXTURE & SUPT EQUIP	14,580			
SPARES	9,720			
GOVERNMENT MANAGEMENT	11,200			
TOTAL	135,000	65,000		

INCLUDES FIRST PROD UNIT 85% LEARNING  INCLUDES ONE FLIGHT UNIT

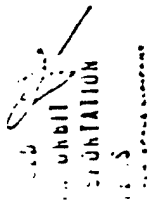

BOEING PROPRIETARY

RASV Flight Test

Outlined are the main phases of the RASV flight test program used in developing costs for this WBS element. The program is consistent with that used for large high performance aircraft. The eight flight tests consist of six flights up through Mach 3 at partial fuel loadings and two orbital flights. The flight test program was man loaded per task as shown in the following figure. The man loading was an estimate based on past experience in supporting test programs. The cumulative costs of labor and materials for the flight test program are shown. All costs are accumulated in the DDT&E phase. Flight testing is conducted by the Air Force. The taxi tests were conducted under the Air Vehicle and Take-Off Support Vehicle DDT&E using a "Boiler Plate" Air Vehicle.

# RASV Flight Test Program

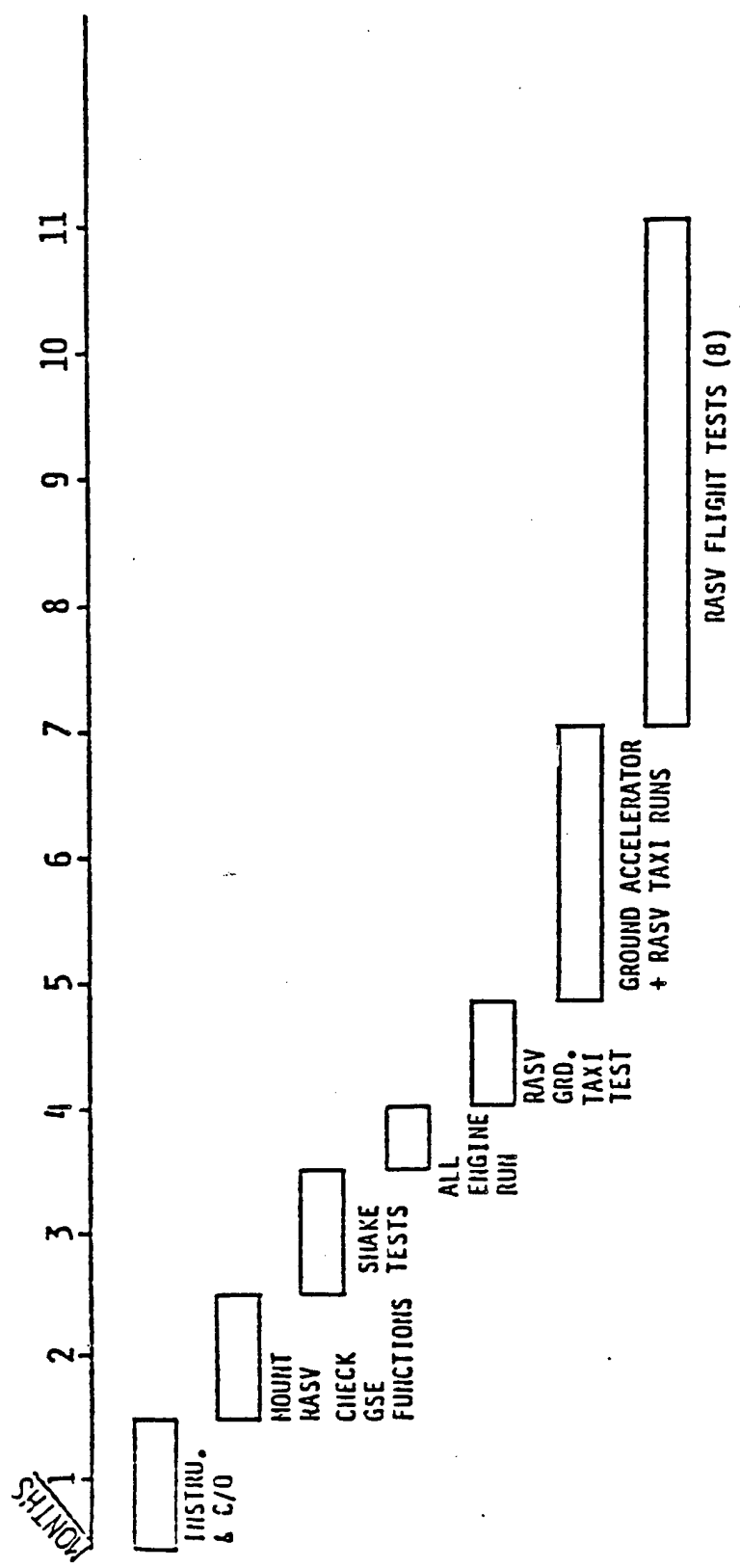

MANNING LEVEL		TASK
40	40	HANDS ON SUPT.
50	50	INST.
30	30	TECH.
40	40	SUPT. FACIL.
100	100	SUPT. FLIGHT OPS

3120 MAN MONTHS      MAT'L = \$7,000,000      COST = \$2,000,000



### Operational Site Activation

Shown is a cost summary of operational site activation. The operational site activation costs include the civil/structural/architectural/electrical design effort, construction or modification of the facility or equipment, assembly of subsystems or components within the facility, checkout and acceptance of the facilities and equipment, and verification by testing. The cost estimates were provided by the Aerospace Corporation with the exception of the contractor technical support. The assumption was made that Edwards Air Force Base would be used as the site for flight test and initial operational flights. This would reduce the facilities' requirements as the site offers numerous existing equipment which could be utilized by the RASV programs during the DDT&E phase. Costs during the operational phase of the program would depend on site selection and number of bases/sites to be built. The estimates per site are provided in the operations section write up.

# Cost Summary Operational Site Activation

1983 DOLLARS

WBS ELEMENT	DDT&E (\$1000)	1st PROD UNIT (\$1000)	PROD (4 UNITS)	TOTAL PROGRAM
CONTRACTOR TECHNICAL SUPPORT	8,100			
FACILITIES A & E				
SITE CONVERSION	136,000			
SYSTEM ASSEMBLY, INSTL. & C/O				
GROUND SYSTEM CONVERSION				
INTEGRATED SYSTEMS C/O	4,900			
GOVERNMENT MANAGEMENT	13,500			
TOTAL	163,000			

## BOEING PROPRIETARY

DDT&E Cost Summary

The WBS Level 2 DDT&E elements are distributed by year from "Authority to Proceed" as shown. The total costs of this phase of the RASV program is \$4,900,000,000 (1983 dollars) with peak annual funding of \$1,400,000,000. These costs do include Government in-house costs and do include anticipated Class I changes.

The DDT&E program costs, developed through "bottom up" estimating were approximately \$630,000,000 higher than those estimated using the Boeing Cost Model. This difference of approximately 15% is well within estimating capability at this stage of the program. The higher figure ("bottom up" estimate) was conservatively selected for use in developing life cycle costs.

# Cost Distribution RASV System - DDT&E

1983 \$ (1,000,000)

ITEM	YEARS							
	1	2	3	4	5	6	7	
DDT&E								
INTEGRATION	2	2	3	3	3	4	3	20
FLIGHT TEST					2	6	24	32
AIR VEHICLE	40	64	320	800	920	1,080	480	3700
GROUND VEHICLE	5	7	65	160	170	100	16	521
AIR CARRY VEHICLE				40	55	40		135
SUPPORT EQUIPMENT		4	16	80	83	93	40	327
OPERATIONAL SITE				10	55	78	20	163
ACTIVATION (WTR)			0	0		0	0	0
FLIGHT SUPPORT								
OPS & SERVICES								
TOTAL	47	77	404	1,093	1,288	1,400	583	4,900

### Operation Costs

The general ground rules and assumptions used in developing operation costs are presented below.

The RASV system is based on complete reuseability and is designed so that airplane techniques of turnaround operations can be applied. The vehicle and facilities have been designed to be mutually compatible with the minimum number of interfaces and cost generating functions (operations) involved. The vehicle has been designed for easy access to on-board systems and components for preflight and postflight checkout activities. Components have been modularized so that items requiring repair or refurbishment can be replaced with a minimum of repair accomplished on board the vehicle.

Subsystems have been selected which will be operationally matured by the Space Transportation System (STS) i.e., Space Shuttle Orbiter. This has a profound effect on reducing maintenance costs especially in the main engine area, where refurbishment costs have a dominant effect on per flight costs. Improvements are projected beyond the Space Shuttle estimates for the SSME, and it is anticipated that further improvements will be developed as the system becomes more operationally mature through extended use and reuse.

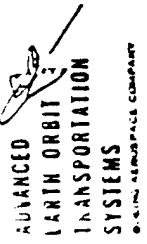

BOEING PROPRIETARY

# Operations General Ground Rules & Assumptions

- 0 COST IN CONSTANT FY 83 DOLLARS
- 0 "COSTS COVER RASV SYSTEM OPERATIONS COSTS ONLY"
- 0 PROGRAM COSTS DEVELOPED ON BASIS OF 5 AIR VEHICLES AND TWO TAKE-OFF SUPPORT VEHICLES AT ONE SITE
- 0 RASV OPERATIONS INCLUDE FLIGHT #9 AND SUBSEQUENT
- 0 SITE OPERATIONAL FACILITIES AMORTIZED OVER 40 YEARS AND APPLIED TO SINGLE YEAR @ 25 FLIGHTS/YEAR/SITE
- 0 OPERATIONS COSTS INCLUDE ALL DIRECT AND INDIRECT FUNCTIONS FOR CONTRACTOR AND GOVERNMENT ACTIVITIES
- 0 PROPELLANT COSTS BASED ON \$1.10/LB LH<sub>2</sub> AND \$.05/LB O<sub>2</sub>

▷ FOR TAV STUDY, LIMITED TO 10 AIR VEHICLES AND 3 TAKE-OFF SUPPORT VEHICLES TO ANY ONE SITE

## BOEING PROPRIETARY

Flight Hardware

As shown, the flight hardware costs include all the equipment and consumables used by the air and ground vehicle. The figure shows the cost/flight which are fixed (not flight sensitive) and variable (directly related to the number of flights). These costs were derived based on the assumption of 25 flights per year.

Air Vehicle

The air vehicle flight hardware costs are made up of the vehicle spares, the sustaining design engineering, transportation and miscellaneous consumables.

Ground Vehicle

The ground vehicle flight hardware costs are made up of the vehicle spares, the sustaining design engineering, transportation and miscellaneous consumables.

Propellants

The propellants include the liquid oxygen and hydrogen used for flight as well as the vent cool down and transfer losses. Also, included are helium and nitrogen pressurant gases. Hydrogen is costed at \$1.10/lb and oxygen at \$.05/lb. Useable propellant is then \$183,000 per flight with a 30% or \$55,000 in unuseable propellant. \$11,000 of the \$248,000 total cost is fixed and accounts for yearly boil off and storage loss.

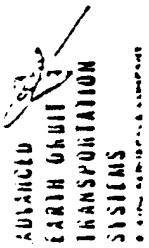

BOEING PROPRIETARY

# Flight Support Operations & Services (Flight Hardware)

D180-27669-4  
341

	COST/FLT =		
	FIXED	VARIABLE	
	(\$1,000)		
FLIGHT HARDWARE			
AIR VEHICLE			
AIR VEHICLE SPARES	36	12	24
SUSTAINING DESIGN ENGINEERING	81	81	
TRANSPORTATION & CONSUMABLES	8		8
GROUND VEHICLE			
GROUND VEHICLE SPARES	9	4	5
SUSTAINING DESIGN ENGINEERING	20	20	
TRANSPORTATION & CONSUMABLES	3		3
CREW COMPARTMENT	2		2
MAIN ENGINES (AIR VEHICLE)	243	52	191
MAIN ENGINES (GROUND VEHICLE)	137	29	108
PROPELLANTS	248	1	237
GSE SPARES	70	26	44
TOTAL	858	253	622

▷ BASED ON 25 FLIGHTS/YEAR/SITE



### Launch Operations

Summarized are the costs for launch operations which include vehicle ground operations, ground system operations, ground system operations, sustaining engineering and logistics support.

### Vehicle Ground Operations

This category includes the contractor manpower required to process the air and ground vehicle and associated ground support equipment. The data base was from a detailed maintenance and operations analysis which is included in Reference (7). Man loading and skill requirements were developed for each task.

### Ground System Operations

This category includes the contractor manpower required to operate and maintain launch related ground support equipment, technical shops and labs, computer services and the launch processing system.

# Flight Support Operations & Services (Launch Operations)

D180-27669-4  
343

	COST/FLT =		VARIABLE
	FIXED		
	\$1,000		
VEHICLE GROUND OPERATIONS			
AIR VEHICLE	151	117	34
GROUND VEHICLE			
GROUND SYSTEM OPERATIONS	184	184	
SUSTAINING ENGINEERING	93	93	
LOGISTICS SUPPORT	37	29	8
TOTAL	465	423	42

BASED ON 25 FLIGHTS/YEAR/SITE

### Flight Operations

Summarized is the flight operations cost. Twenty-five direct people are associated with the costs of operating, maintaining, and providing necessary modifications of on-board avionics software and ground mission control systems. Also included is the effort associated with mission planning, documentation, operation, and maintenance for the simulators.

The 25 people for crew operations include effort for crew training and procedures, flight crew documentation, flight control systems engineering support, flight planning, operation, and maintenance of training aircraft.

# Flight Support Operations & Services (Flight Operations)

D180-27669-4  
345

COST/FLT  
\$1,000

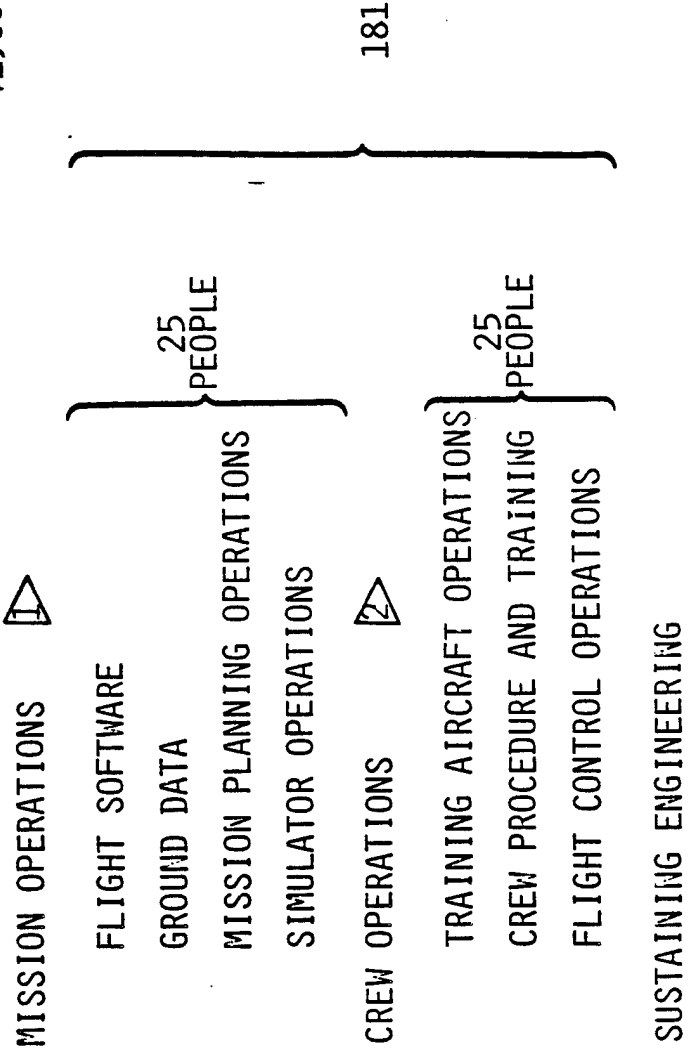

181K

TOTAL

BASED ON 25 DIRECT PEOPLE FULL TIME

BASED ON 25 DIRECT PEOPLE FULL TIME

BASED ON 25 FLIGHTS/YEAR/SITE

1

2

BOEING PROPRIETARY

Summary - Flight Support Operations & Services

The cost per flight of \$1,503,000 covers those costs associated with maintaining, servicing and operating the RASV system. It does not include costs associated with payloads.

The costs are based on 25 flights/year/site.

# Flight Support Operations & Services (Summary)

D180-27669-4  
347

COST PER FLIGHT

FLIGHT HARDWARE	858,000
FLIGHT OPERATIONS	181,000
LAUNCH OPERATIONS	465,000
TOTAL	<u>\$1,503,000</u>

BASED ON 25 FLIGHTS/YEAR/SITE

**BOEING PROPRIETARY**Operational Site Activation

Operational Site Activation costs were developed using the facility costs presented for Mission Operations and Base Support. The site has a single take-off runway with two revetments at the west end. Facilities are planned around four (4) active and one (1) reserve RASV at the site. Facility costs were extracted from Space Shuttle Launch Site Implementation planning data and consultation with Air Force (S.D.) and Aerospace personnel.

A cost of \$350,000,000 may be used for activating any site. Small variations will occur dependent on existing equipment.

Increasing the number of air vehicles to 10 per site may dictate a third take-off/fueling revetment and increasing cryogenic storage to 3.5 launches. These requirements would add approximately \$40,000,000 to the site activation costs.

# RASV Facilities - Base Support

D180-27669-4

349

	COSTS (1983 \$M)
MEDICAL FACILITY	.9
FOOD SERVICES	1.3
BASE UTILITIES (WATER, GAS, SEWER, POWER, COMMUNICATIONS)	19.4
UTILITY SOURCES	3.2
RAILROAD SPUR	1.6
CENTRAL HEATING--A/C PLANT	16.0
CENTRAL FIRE STATION	.8
BASE SECURITY FACILITIES	.8
BASE SUPPORT FACILITY	2.0
MOTOR POOL AND HEAVY EQUIPMENT FACILITY	1.6
WAREHOUSING	4.8
ROADS AND PARKING	6.5
AREA LIGHTING	1.6
MISCELLANEOUS SUPPORT FACILITIES	12.1
BASE HOUSING	1.6
PRECISION MEASUREMENTS EQUIPMENT LABORATORY	.4
	<u>\$74.6 M</u>
MISCELLANEOUS ITEMS (15%)	11.2
ENGR., DESIGN, SUPERVISION AND ADMINISTRATION (13%)	<u>10.0</u>
ESTIMATED DESIGN/CONSTRUCTION COST	\$95.8 M



# RASV Facilities--Mission Operations

1983 DOLLARS

	<u>COST \$M</u>	<u>COST \$M</u>	
TAKEOFF (FUELING) REVETMENT (2)	32.0	ELECTRONIC SUPPORT FACILITY	3.0
TAKE OFF RUNWAY MOD.	16.0	TECHNICAL SUPPORT FACILITY	2.0
AIR FERRY LOADING DOCK	.4	COMMUNICATIONS & DATA STORAGE	3.0
LANDING FACILITY IMPROVEMENTS	16.0	LH <sub>2</sub> PRODUCTION PLANT	12.0
HYPERGOLIC SERVICING FACILITY	2.0	LH <sub>2</sub> STORAGE (2½ LAUNCHES)	7.0
MISSION CONTROL & DATA PROCESSING	24.0	LH <sub>2</sub> SUPPLY LINES	3.0
STORAGE FACILITY (1/VEH.)	1.0	LO <sub>2</sub> PRODUCTION PLANT	10.0
MAINT. AND REFURB. BLDG.	24.0	LO <sub>2</sub> STORAGE	7.0
TOWAYS	13.0	LO <sub>2</sub> SUPPLY LINES	.3
(PAYLOAD PROC. FACILITY--TBD)		ORDNANCE STORAGE IGLOO	
FLT. CREW TRAINING FAC. (1 BASE ONLY)	4.0		
ADMIN. AND TECH. OFFICES	11.0	MISCELLANEOUS ITEMS (15%)	30.0
CONTRACTOR SUPPORT FACILITY	2.0	ENGR. DESIGN, SUPERVISION & ADM. (13%)	26.0
FLIGHT CREW QUARTERS	1.0	ESTIMATED DESIGN & CONST. COST	\$255.0 M
PROP. SYSTEM COMP. FAC.	3.0		
PROPELLANT TEST FACILITY	2.0		
		SUBTOTAL	199.0 M

△ HYDROGEN PRODUCTION FACILITY NOT INCLUDED--HYDROGEN COSTS INCLUDE FACILITY WRITE-OFF.

THIS PAGE INTENTIONALLY LEFT BLANK

**BOEING PROPRIETARY**

**RASV UNIT COST--PRODUCTION**

Production unit costs (1983 \$) for the air vehicle, take off support vehicle and operating base support equipment is defined.

An 85% learning curve for these hardware items was established by ECON corporation and approved by Air Force Space Division during a costing study conducted by ECON under Air Force contract.

The use of an average value after the 20th air vehicle and the 8th take off support vehicle simplifies establishing various fleet size costs.

# RASV Unit Cost--Production (1983 \$)

<u>Air Vehicle</u>		<u>Take-Off Supt. Veh.</u>		<u>Support Equipment</u>	
<u>Vehicle No.</u>	<u>Unit Cost M\$</u>	<u>Vehicle No.</u>	<u>Unit Cost M\$</u>	<u>Prod. Unit No.</u>	<u>Unit Cost M\$</u>
6	281	2	94	2	96
7	274	3	87	3	87
8	265	4	82	4	81
9	259	5	78	5	78
10	253	6	75	6	76
11	248	7	72	7	74
12	243	8	70	8	72
13	240			9	69
14	235			10	67
15	233				
16	228				
17	225				
18	222				
19	220				
20	217				

Use \$65M as Average  
Cost for Next 22  
Vehicles.

Use \$200M as Average  
Cost for Next 80  
Vehicles.

## BOEING PROPRIETARY

## RASV TOTAL VEHICLE INVESTMENT COSTS

The total vehicle investment costs are shown.

Three Take Off Support Vehicles(TOSV) are planned for every ten TAV (Air Vehicles). For the first five TAV, two TOSV are supplied. From that point on, the three TOSV to 10 TAV ratio applied.

The support equipment to TAV ratio of .1 is considered to be consistent with launch rates of 20 to 30 per take off site. This ratio is used to establish the TAV plus support equipment cost curve.

The total system costs are the sum of the TOSV and TAV plus support equipment costs.

BOEING PROPRIETARY

# Total Vehicle Investment Costs as a Function of Number of Vehicles in Fleet by the Year 2000 (RASV)

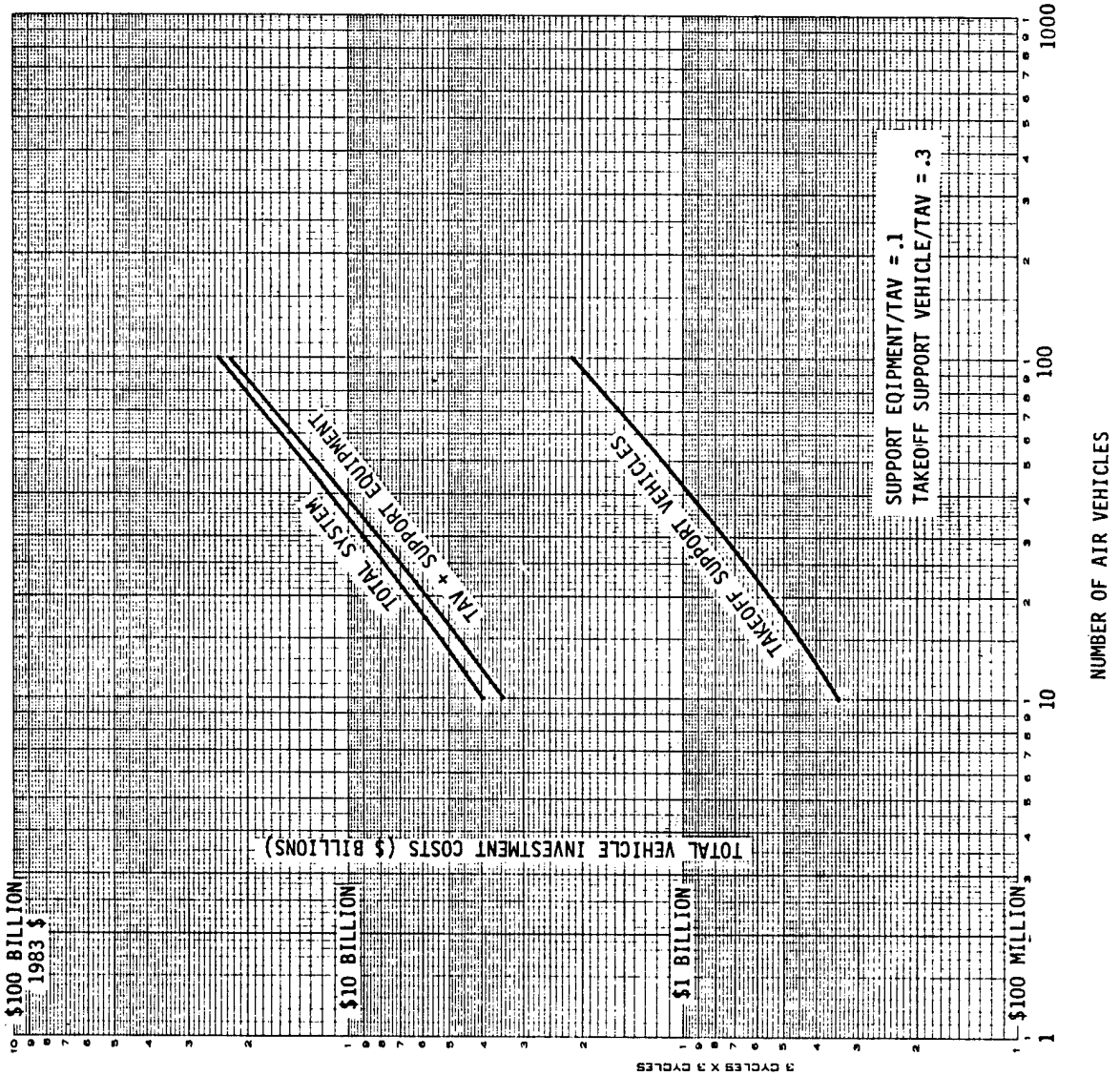

## BOEING PROPRIETARY

## RASV TOTAL FACILITY INVESTMENT COSTS

The facility costs for the first ten Air Vehicles located at one takeoff site include the 747 carrier airplane and associated components costed in the DDT&E program. As noted, going from a fleet of five to ten Air Vehicles at one site increased facility costs by an estimated \$40,000,000. For the second block of ten Air Vehicles, a second 747 carrier airplane and associated components are included in the facility costs. No additional 747 aircraft are procured as additional Air Vehicles and Takeoff Support Vehicles are added to the fleet.

BOEING PROPRIETARY

# Total Facility Investment Costs as a Function of Number of Vehicles in Fleet by the Year 2000 (RASV)

D180-27669-4

357

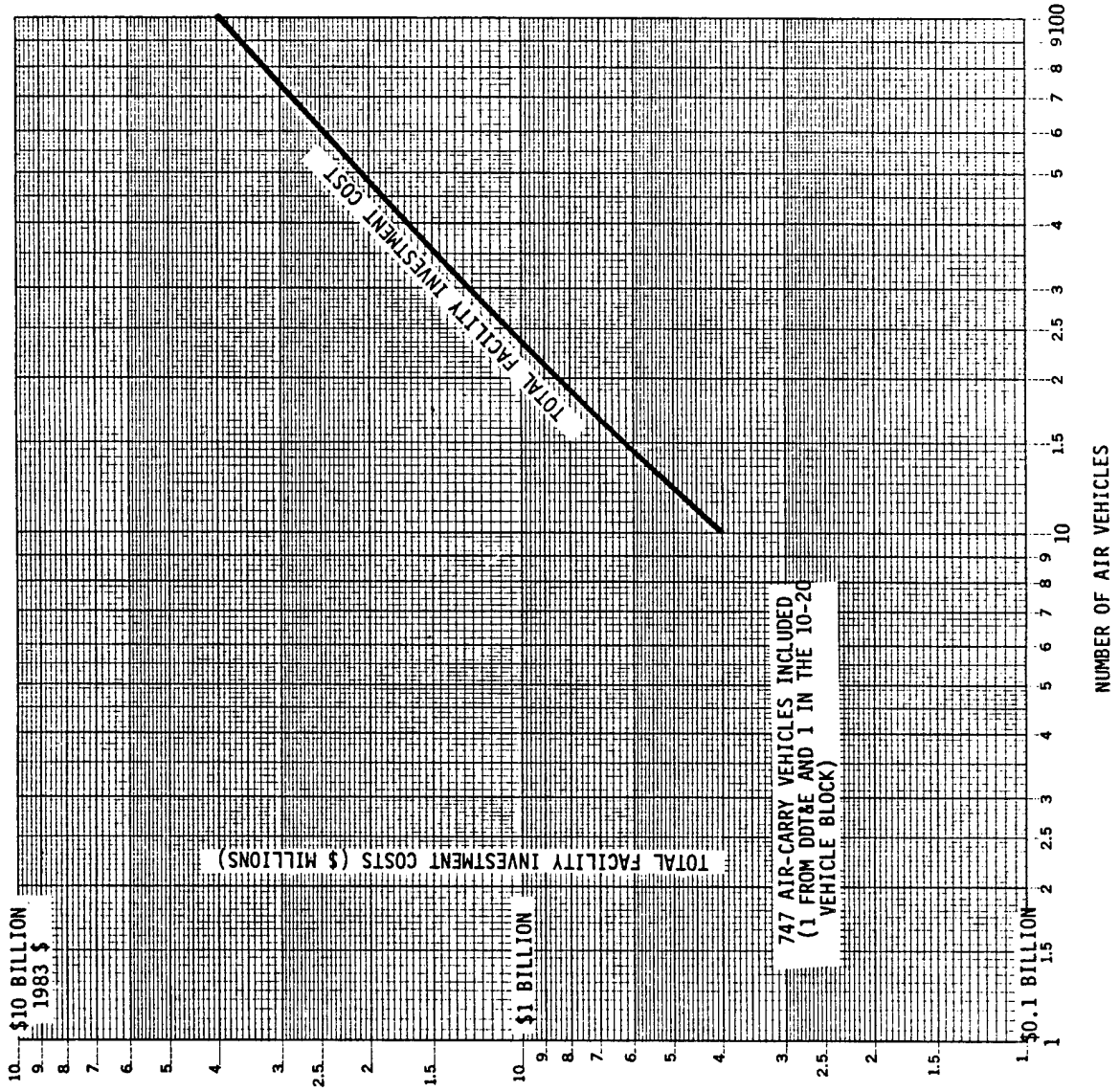



**BOEING PROPRIETARY**  
**RASV TOTAL OPERATIONAL COSTS**

For five flights/year/TAV with ten TAV/site, the yearly fixed costs are those used in developing the twenty-five flights/year/site operational costs. These fixed costs had been estimated on the basis of forty-five flights/year site. They were not changed when the fixed costs were established for the twenty-five flights/year/site.

For the ten flights/year/TAV with ten TAV/site, the fixed costs/site are increased fifty percent. It is expected that one hundred flights/year/site would require additional staffing over the fifty flights/year/site.

For the fifteen flights/year/TAV, the number of TAV/site is reduced to five. Total flights per site greater than one hundred/year may be excessive. Therefore, an average value of seventy-five flights/year/site is selected. This of course reduces the number of TAV to five/site. Fixed costs/site/year are the same as for the five flights/year/TAV, ten TAV/site operation.

# RASV Operational Costs as a Function of Number of Vehicles and Number of Flights

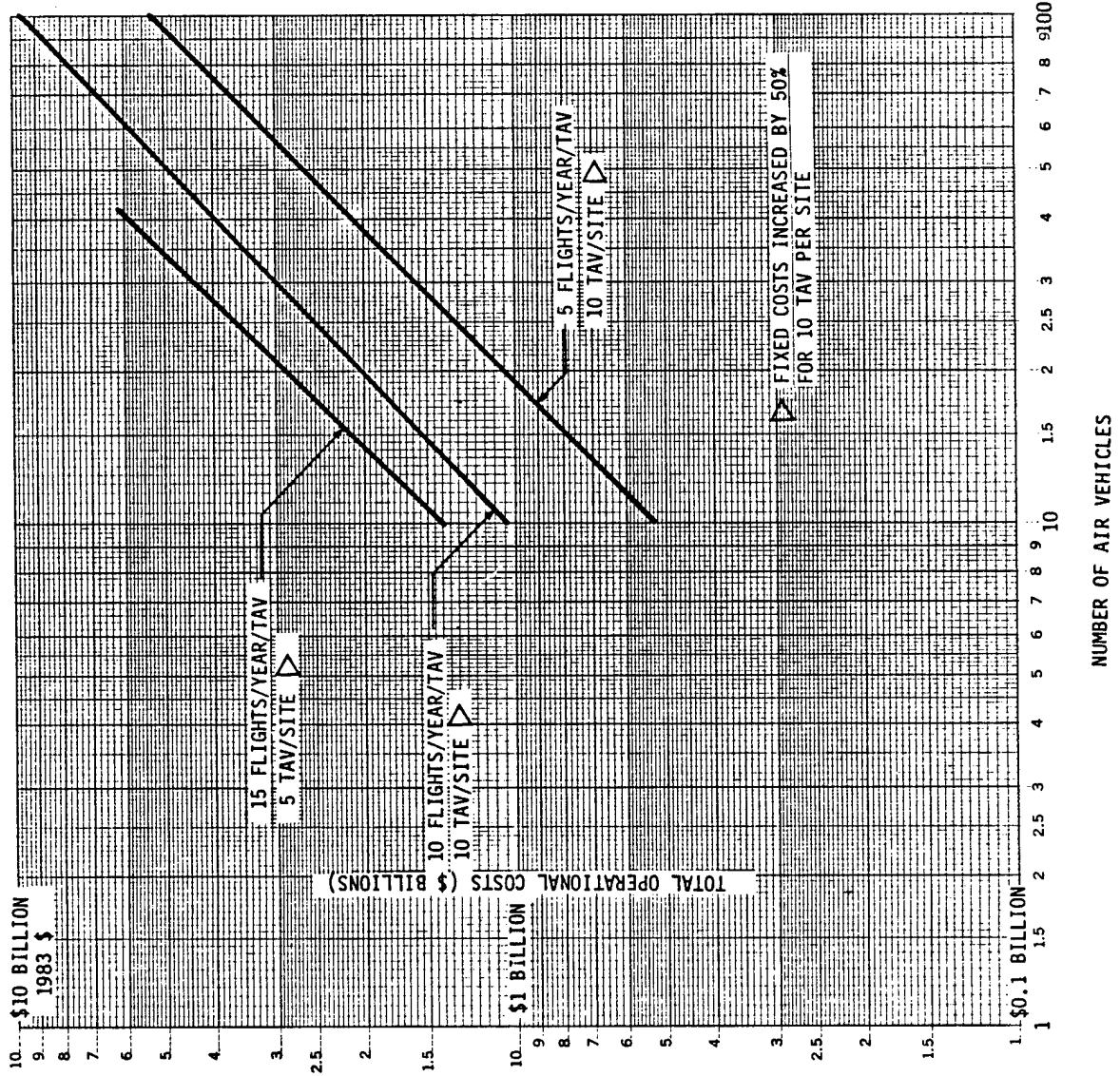

## RASV TAV COST SCENARIO

COST CATEGORY	COSTS IN MILLIONS \$ 1983			
	TAV ORBITER	TAKE OFF SUPT. VEHICLE	OTHER	TOTAL
DDT&E COSTS				
SYSTEMS DESIGN				
TEST ARTICLES FABRICATION AND TECHNOLOGY DEVELOPMENT				
GROUND AND FLIGHT TESTS AND EVALUATION				
SUBTOTAL	\$3,752.00	\$521.00	\$ 630.00	\$ 4,900.00
HARDWARE/FACILITY INVESTMENT COSTS				
REPRODUCTION FACILITIES	400.00			
VEHICLE PRODUCTION	11,214.00			
AIR FORCE FACILITIES (4 + DDT&E SITE)			\$2,960.00	
SUPPORT EQUIPMENT			824.00	
AIR TRANSPORT VEHICLE			64.00	
SUBTOTAL	\$11,614.00	\$1,281.00	\$3,788.00	\$16,683.00
OPERATIONS COSTS				
PERSONNEL (NUMBER/TYPE/COSTS)				
TAV SYSTEM PROPELLANTS				
REPAIR PARTS/SPARES				
OTHER				
SUBTOTAL $\triangle$				\$ 5,612.00
SCENARIO TAV PROGRAM TOTALS .				\$27,195.00

$\triangle$  BASED ON TEN SITES; TEN FLTS/SITE/YR.

## NOTES:

## 1. TAV PRODUCTION SCENARIO ASSUMPTIONS

(A) FLEET SIZE: ORBITERS--50 (PRODUCTION AND DELIVERY OF TEN ORBITERS PER YEAR BETWEEN 1995--2000)

BOOSTER/CARRIERS--NUMBER REQUIRED TO SUPPORT ORBITER SPACEFLIGHTS (CONSTANT RATIO)

(B) FLIGHT RATE: 100 FLIGHT PER YEAR

(C) OPERATIONAL PERIOD: 20 YEARS

### **3.3.4 Technology Risk Assessment**

### **3.3.5 Requirements Compliance**

### **3.3.6 Conclusions**

## LABORATORY TECHNICAL ACQUISITION PLAN

The major development requirement for the RASV and generic systems is the airframe. The materials are available in all forms in production quantities. The required material, process and fabrication process specification need development verification, structural allowables developed and verified and all data validated by the design, build and testing of structural assemblies. Detail development programs have been documented.

The Ascent Propulsion Engine, SSME, requires development and verification of dual expansion nozzles and verification of the engine pumps to perform under low tank ullage pressure.

Running gear for the ground acceleration needs development.

Wind tunnel test data needs to be acquired for both aerodynamic heating and force data.

# LABORATORY TECHNICAL ACQUISITION PLAN

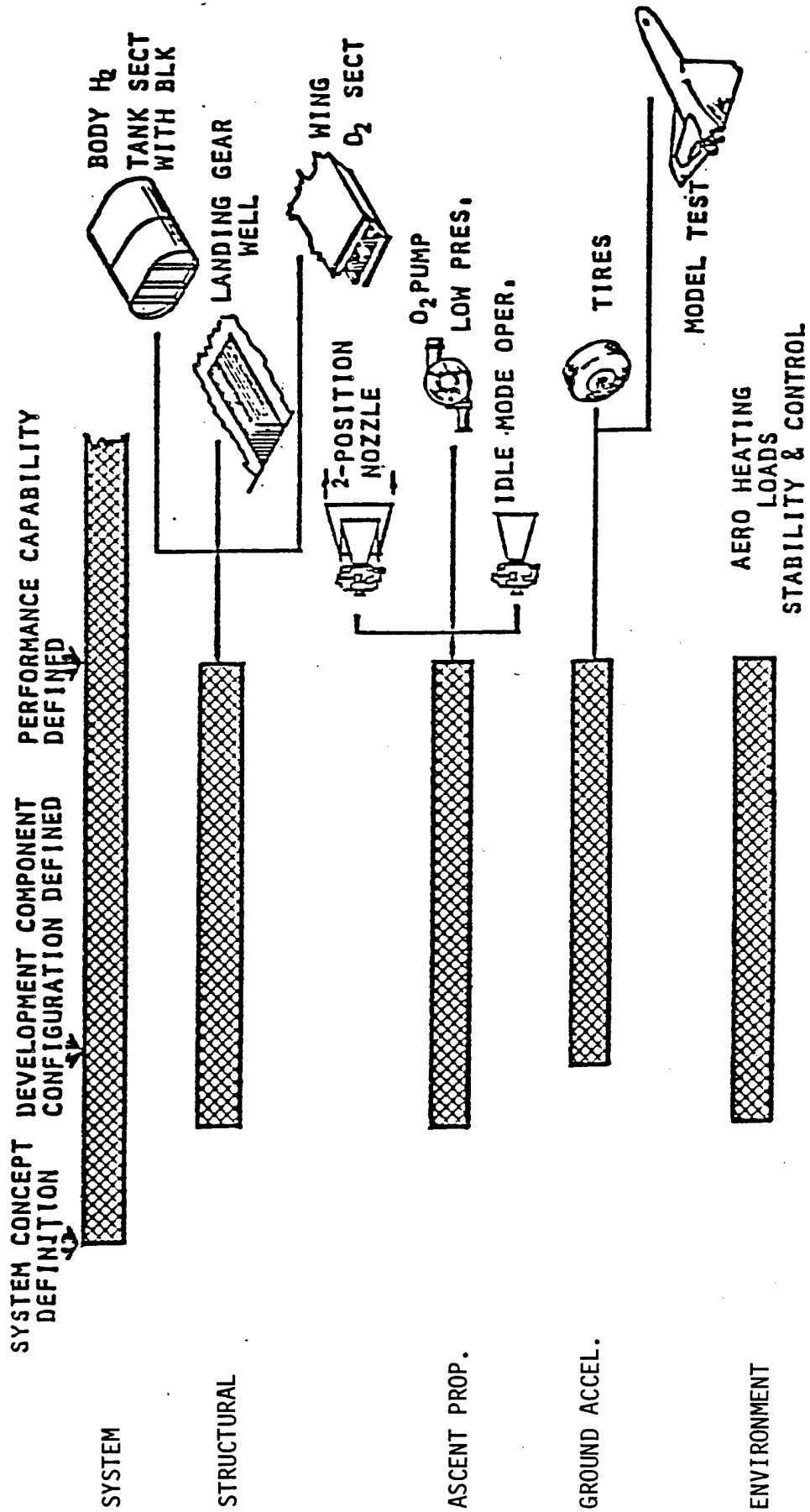

# Rocket Airplane Development Program Results

- Airframe
  - Manufacturing Processes
  - Structural Design Data
  - Producibility
  - Structural Integrity
  - Weight
- Integrated Propulsion
  - Wet Airframe
  - Tank Pressurization By Aerodynamic Heating
  - Demonstrated Operation
- Aero Configuration
  - Aero Heating Design Data
  - Performance

# Technology Requirements Rocket Powered Aircraft

- AIRFRAME: WEIGHT AND MULTI-MISSION STRUCTURAL INTEGRITY
  - HOT STRUCTURE INTEGRAL CRYOGENIC TANKAGE
  - STRUCTURAL ELEMENT DESIGN DATA
  - STRUCTURAL ASSEMBLY TEST
- OPERATING ENVIRONMENT: SURFACE TEMPERATURES
  - WIND TUNNEL AERODYNAMIC HEATING RATES AND PRESSURES
- FLIGHT VEHICLE: AERODYNAMIC PERFORMANCE AND HANDLING QUALITIES
  - WIND TUNNEL AERODYNAMIC FORCE DATA
  - PERFORMANCE AND STABILITY AND CONTROL ANALYSIS
  - CONTROL SURFACE POWER REQUIREMENTS
- GROUND FUELING: COST, FACILITIES
  - SYSTEM DESIGN ● SYSTEM TEST
- TAKE-OFF SUPPORT VEHICLE RUNNING GEAR: STRENGTH-LIFE
  - TIRE AND WHEEL
  - DESIGN DATA ● ASSEMBLY TEST
- ROCKET PROPULSION:  $I_{SP}^{VAC} \approx 463 \text{ SEC.}, \text{ LIFE}$ 
  - HIGH PERFORMANCE NOZZLE
  - DESIGN DATA ● MODEL TEST ● BREADBOARD TESTS



## AIRFRAME

The airframe component development and validation is planned to follow the sequence outlined. The initial task would be to design build, and test a representative wing box section for concept demonstration. This would be followed by building an assembly that would include both wing and body sections. This section would be installed in fore and aft test fixtures representing continuation of the tanks. The section would be both leak and proof tested under combined internal pressure and temperature

# Airframe

## Integral Cryogenic Fuel Tank

- Operating Temperature Range  $-420^{\circ}\text{F}$  to  $1500^{\circ}\text{F}$
- Rene'41 and Titanium Honeycomb Surfaces

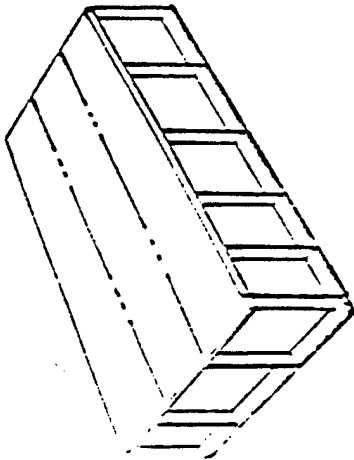

Concept Demonstration

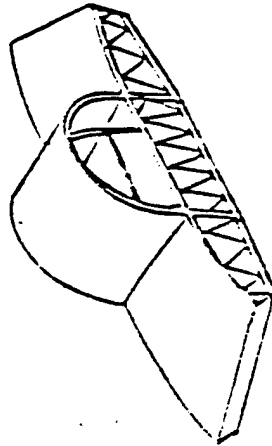

Integrated Assembly

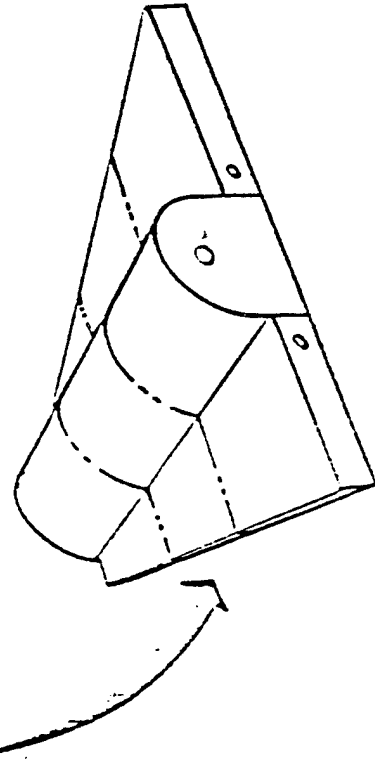

Fuel Tank Assembly  
Integrate Propulsion  
Evaluation

RASV COMPLIANCE

TAV OPERATIONAL REQUIREMENTS

The RASV is fully compliant with the TAV operational requirements. The total design of the RASV system has been controlled to meet the requirements. Requirements identical to the TAV's were used in both early formulation and subsequent detail analysis of the RASV system. Compliance with these requirements is demonstrated in the reference documents attached to this report. The key RASV characteristics that show compliance are listed under each requirement.

# RASV Compliance TAV Operational Requirements

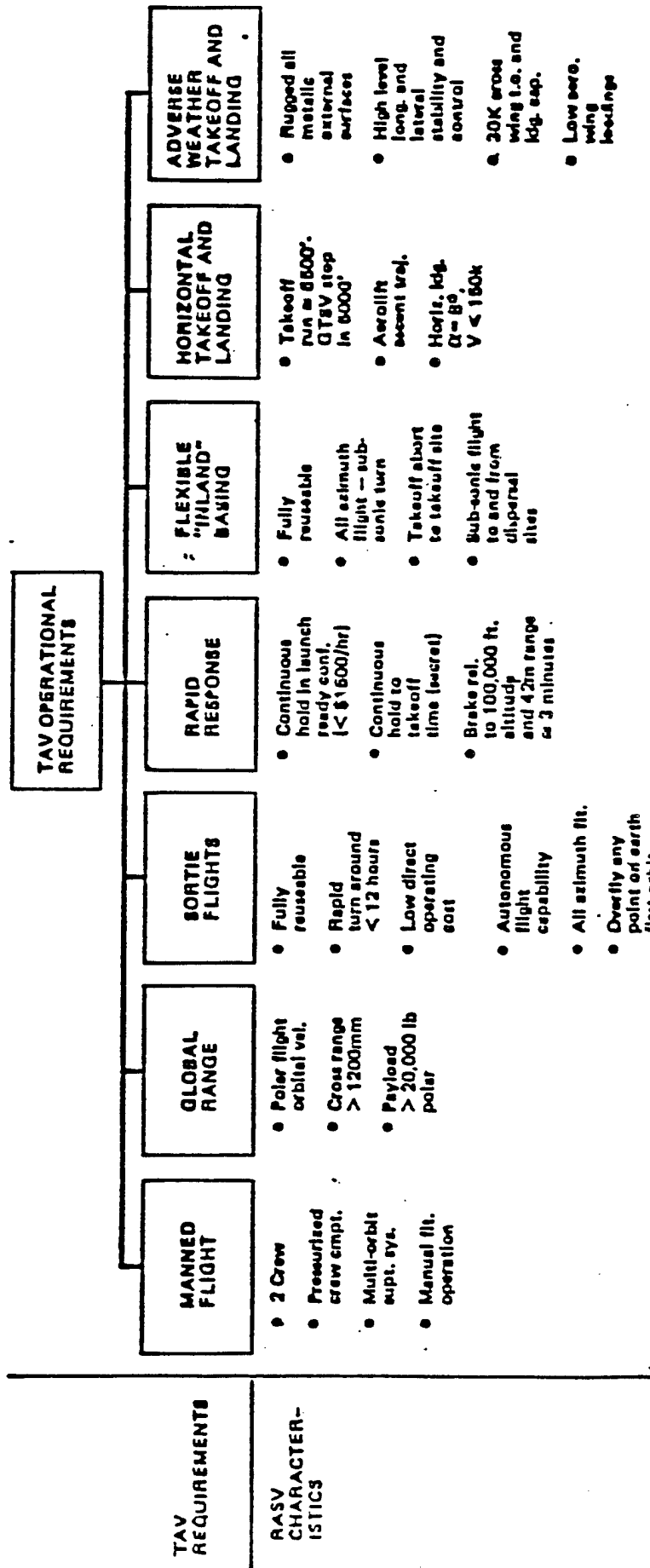

**BOEING PROPRIETARY****RASV COMPLIANCE  
TAV DESIGN GOALS**

The RASV is fully compliant with the TAV design goals. The RASV is a fully reusable, rugged, durable system that takes off horizontally with a single stage to accomplish both once around (ConUS to ConUS) and multiorbit flights. It can fly into any launch azimuth from a single easterly runway. The payload of 22,000 pounds polar once around exceeds the design goal. Under Air Force sponsorship, detail time lines and functions have been defined for both response time and turnaround times. These data are documented in classified reports.

Technical analysis demonstrating compliance with these TAV design goals is contained in a series of documents produced under Boeing IR&D and Air Force and NASA contracts.

# RASV Compliance with TAV Design Goals

TAV Design Goals	RASV Capabilities
(1) Response Time 5 Minutes Launch (From Alert Status)	SECRET--Ref. SAMSO TR-78-40, Vol. III
(2) Turnaround Time Two Missions/Day	SECRET--Ref. SAMSO TR-78-40, Vol. III
(3) Fully Reusable System	YES --Ref. SAMSO TR-76-223, Vol. II and III
(4) Single Stage Ground Launch	YES --Ref. SAMSO TR-76-223, Vol. II and III
(5) Baseline Payload (20,000# Polar Once Around)	YES --Polar Once Around Payload - 22,000# T.O. Site - Grand Forks, N.D.
(6) Maximum On-Orbit Stay-- Few (2 or 3) Orbits	YES --Requires $\Delta$ Wt. Increase of 2700 lbs. for Orbit and De-orbit Control $\Delta$ V 125 ft./sec.

## REFERENCES

1. Boeing Aerospace Company: "Advanced Space Lift Study for Mission Analysis on Future Military Space Activities,"--A.F. Contract F04701-75-C-0208, Boeing Document D180-18856-1.
2. Boeing Aerospace Company: "Feasibility Study of Reuseable Aerodynamic Space Vehicle," SAMSO TR-76-223, September, 1976, Vol. 1, 2, and 3.
3. Hepler, A. K. and Bangsund, E. L.: "Technology Requirements for Advanced Earth Orbital Transportation Systems," NASA Report 2879, July, 1978 and NASA Report 3037, "Dual Mode Propulsion."
4. "Rene'41 Brazed Honeycomb Development," Contract (NASA) NAS1-14213, NASA Report 3382, January, 1981.
5. "Strategic Air Command Systems Operational Need," Space Launch/Flight System 07-79
6. "Air Defense Command General Operational Requirements," Space Launch/Flight System 06-78.
7. Boeing Aerospace Company: "Reuseable Aerodynamic Space Vehicle System Design and Analysis," SAMSO Report TR-78-40, Vol. 1, 2, and 3.
8. Hepler, A., Swegle, A., Dishman, G., and Deriugin, V.: "Reusable Aerodynamic Space Vehicle (RASV) Structural Weight Validation Body Payload Bay/Wing Region Report," SD TR-79-15 Vol. 1, February, 1979.
9. Hepler, A., Swegle, A., Dishman, G., and Deriugin, V.: "Reusable Aerodynamic Space Vehicle (RASV) Structural Weight Validation Aft Body Pressure Bulkhead and Engine Support Structure," Report SD TR-79-15, Vol. 2, August, 1979.
10. "Boundary Layer Analysis Program," Boeing Coordination Sheet 2-5500-DP30-63, October 21, 1975.
11. Fivel, H. J.: "Numerical Flow Field Program for Aerodynamic Heating Analysis," Vols. I and II, AFFDL TR-79-3128, December, 1979 (AEROHEAT).
12. "The Improved Convective Heating and Ablation Program (CHAP)," Boeing Document D2-126104-1, August, 1974.
13. "Boeing Engineering Thermal Analyzer Program (AS1917)," Boeing Document D180-10016-1, September, 1970.
14. Revision to "Reuseable Aerospace Vehicle (RASV) Structural Criteria," memorandum 2-5000-001-266 from Swegle, A. R. and Hepler, A. K., dated April 24, 1979, to Aerospace Corporation, P. O. Box 92957, Los Angeles, CA, Attention: Normal Au.

REFERENCES (Continued)

15. Swegle, A. R., "Advanced Space Transportation System Research 1974 IR&D Summary," Boeing Document D180-18622-1, 1975.
16. Boeing Aerospace Company: "A Study of Flight Control Requirements for Advanced, Winged, Earth-to-Orbit Vehicles With Far-Aft Center of Gravity Locations," NASA Report 3491.



THIS PAGE INTENTIONALLY LEFT BLANK

## 4.0 Recommendations

### 4.1 Effectiveness Evaluation Tasks

### 4.2 Recommendations For Phase II

#### EFFECTIVENESS EVALUATION TASKS

Task C, Phase 1, of the "Transatmospheric Vehicle Concept Development and Evaluation" contract requires the subcontractor to provide to Battelle inputs for the Phase 2 Program Plan. The following discussion outlines a suggested methodology that could be used to compare selected TAV concepts against alternative aeronautical systems and space-based concepts in the mission/threat environment of the post 1995 time frame.

Effectiveness Evaluation Tasks can be grouped into two main categories: 1) Input Database Tasks, and 2) Evaluation Tasks. Input Database Tasks are conducted once at the beginning of the study. Evaluation Tasks are conducted for each TAV and alternate system, mission, and conflict level.

Recommendations regarding assignment of task responsibilities are made at the end of this briefing.

# Effectiveness Evaluation Tasks

- INPUT DATABASE TASKS
  - SELECT MISSIONS
  - SELECT ALTERNATE SYSTEMS
  - COLLECT SYSTEM PERFORMANCE DATA
  - DEFINE SCENARIOS
  - DETERMINE PAYLOAD SYSTEM CHARACTERISTICS
  - DETERMINE SYSTEM LCC
  - DETERMINE OPERATIONAL GROUND RULES
  - DETERMINE MISSION/CONFLICT LEVEL CONCURRENCY GROUND RULES
- EVALUATION TASKS
  - DETERMINE MISSION FEASIBILITY
  - DETERMINE CONCEPT OF OPERATIONS
  - SELECT APPROPRIATE PAYLOAD
  - IDENTIFY ALTERNATE MULTIMISSION SYSTEMS
  - DEFINE MULTIMISSION SYSTEM
  - DETERMINE MULTIMISSION SYSTEM LCC

### SYSTEMS SCREENING I - MISSIONS COMPATIBILITY

A complete list of alternative aeronautical systems and space-based concepts is likely to be long. A series of three screens or gates could be used to reduce this list to manageable size.

The first of these gates is the screen for mission capability. Inputs to this task are 1) a description of the mission in each of five conflict levels, 2) the complete list of TAV systems and alternative systems, and 3) performance data for each system.

A review of the input data would allow a rough-cut evaluation of the ability of a given system to satisfy a particular mission/conflict level, e.g., an MX missile would not be used for a peacetime mission.

The output of this step is a systems/mission matrix showing the systems that could be used for each mission. Additional matrices are completed for each conflict level.

# Systems Screening I - Mission Compatibility

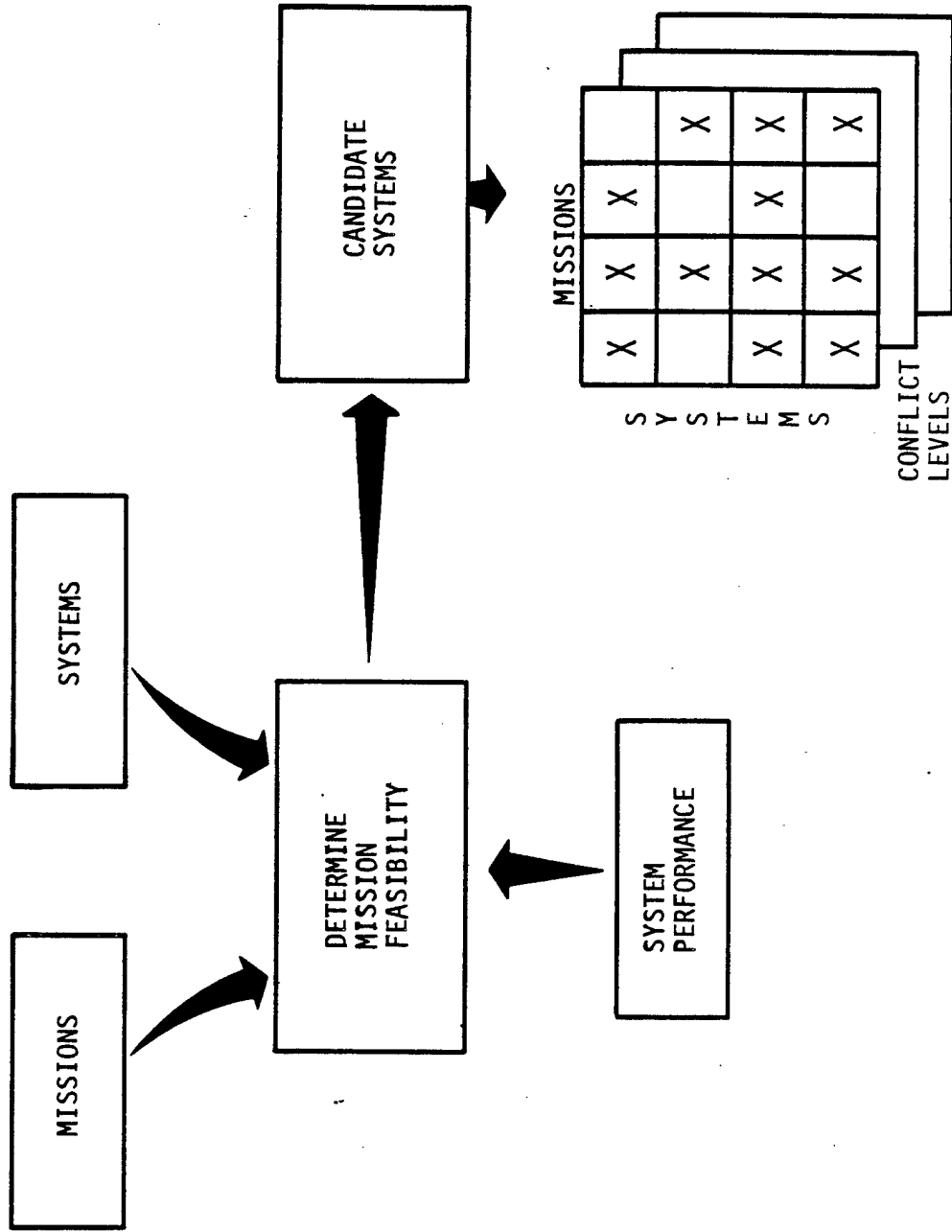

## SYSTEMS SCREENING II - CONCEPT OF OPERATIONS

The second of the alternative systems reduction gates is the screen for concept of operations.

Inputs to this task are 1) the alternative systems that survived the first gate, 2) a scenario for each mission/conflict level combination that is representative for each situation, and 3) a list of operational ground rules, e.g., horizontal take off and landing, fully reusable, maximum on-orbit stay of a few orbits, etc.

Using the concept of operations already developed for each system, decisions could be made regarding which candidate systems could meet scenario and operational ground rule requirements.

Two outputs would be provided. The first is a set of matrices similar to Screen I matrices except that the number of system entries has been reduced. The second is a set of individual system data that were generated as a result of developing individual concept of operations and scenario data, e.g., flight profiles, orbital parameters, basing concepts, launch strategy, mission timelines.

# Systems Screening II - Concept of Operations

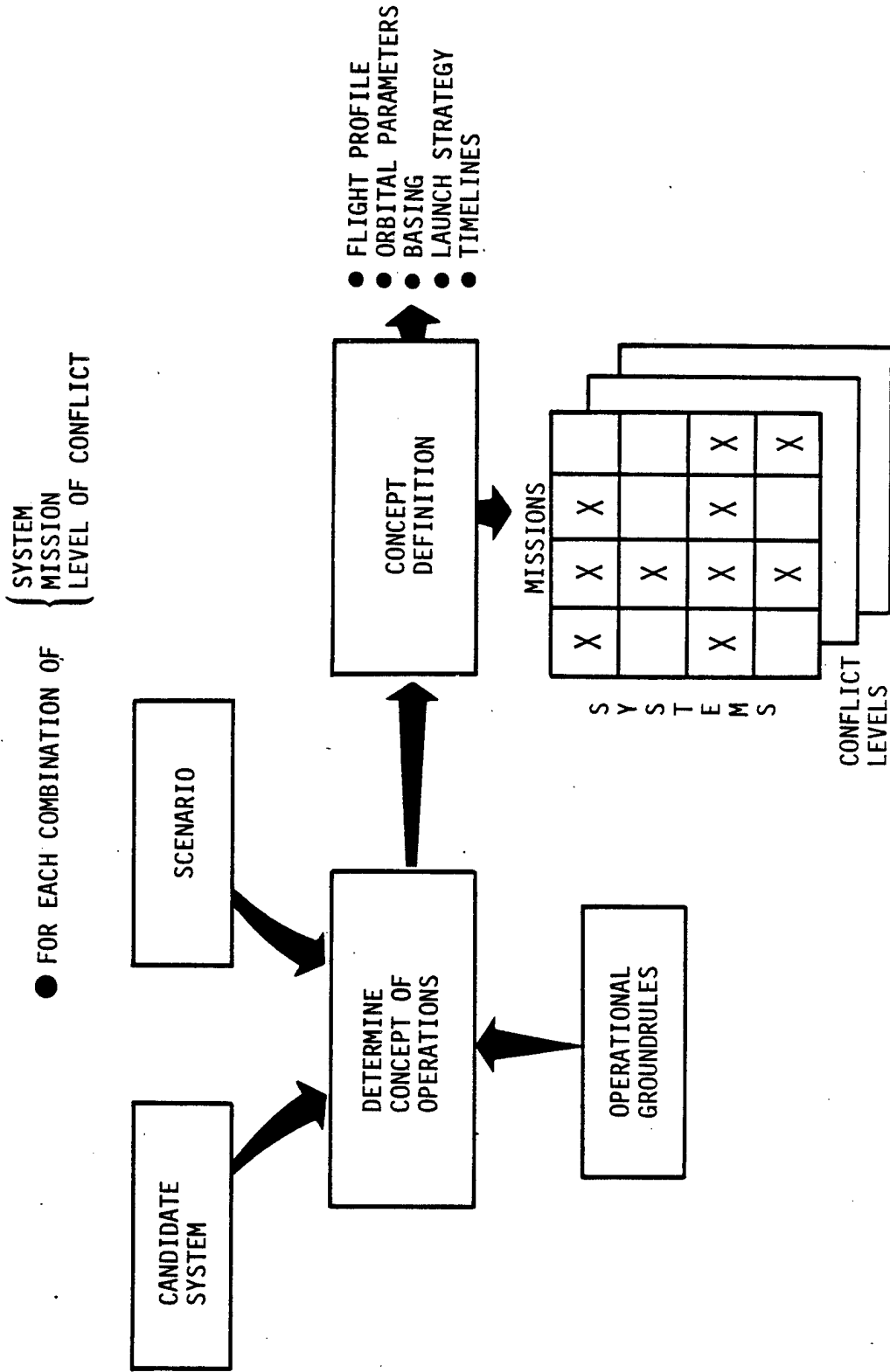



### SYSTEMS SCREENING III COMPLETE SYSTEM DEFINITION

The third of the alternative systems reduction gates is the screen for complete system definition.

Inputs to this task are 1) concept of operations data that were generated for the previous task, 2) scenario data that were also generated for the previous task, and 3) payload characteristics describing performance and physical characteristics for each payload assigned to each alternative system. These data should be available from the SPO for each candidate system.

A determination could be made whether a candidate system has a payload capability which satisfies each scenario and concept of operations.

Two outputs could be provided. The first is a set of matrices similar to Screen I and Screen II matrices except that the number of system entries has been reduced. The second is fleet size and basing data for each system. These data are derived from the study showing the capability of various payload/vehicle combinations to satisfy each concept of operations of a given scenario, e.g., vehicle quantity, basing.

# Systems Screening III - Complete System Definition

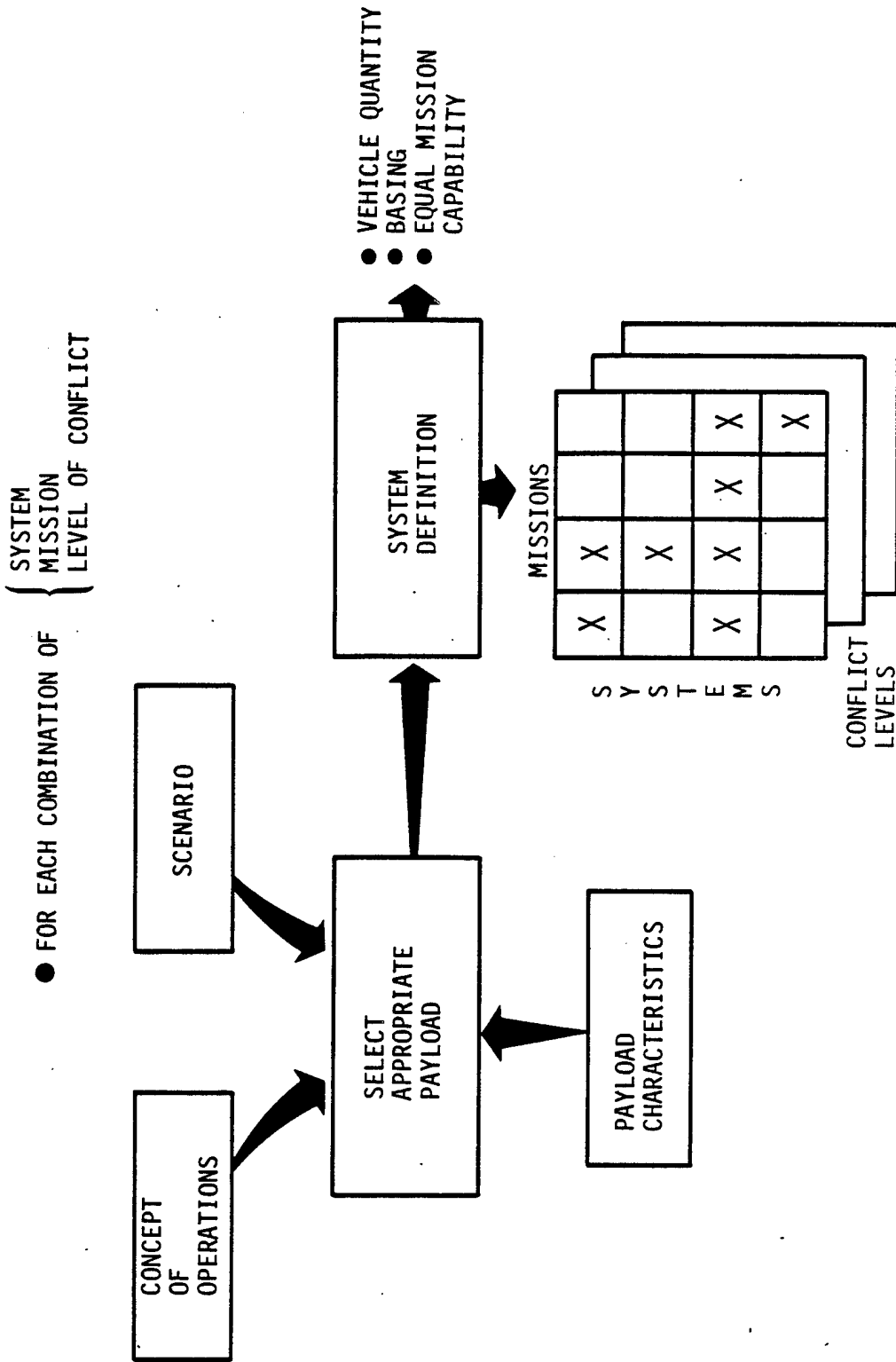

## IDENTIFY COMBINATIONS OF SYSTEMS WHICH PERFORM ALL MISSIONS

For the purposes of establishing a baseline for making an effectiveness evaluation based on life cycle costs, an assumption is made that the four mission areas and the five conflict levels cover the total span of interest. Weapons planners, then, would develop and deploy sufficient system combinations to satisfy all mission/conflict requirements.

The output matrices from Screen III could be reordered to show the various combinations available for each mission/conflict level.

In the example shown, for one conflict level, system 3 could perform all missions. Another combination of system 1 for missions 1 and 2 and system 3 for missions 3 and 4 also performs all missions. A third combination system 1 for mission 1, system 2 for mission 2, system 3 for mission 3, and system 4 for mission 4 also performs all missions.

# Identify Combinations of Systems Which Perform All Missions

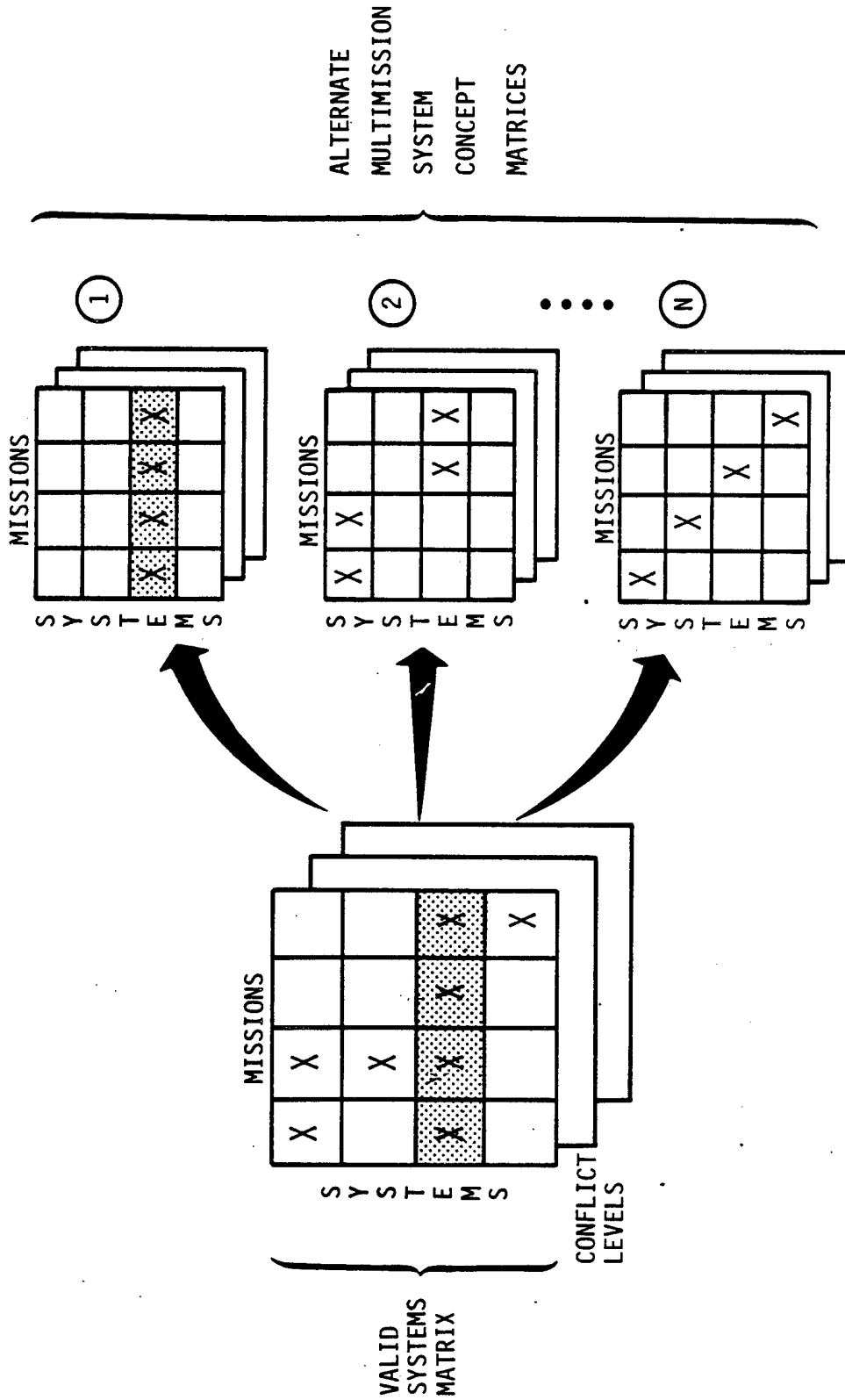

#### MULTIMISSION SYSTEM DEFINITION

Up to this point, each mission/conflict level matrix has been considered as occurring independently and in its own period of time. This situation is not realistic. The two extreme cases would be 1) if all mission events would occur in the same time period, the maximum amount of equipment and supply would be necessary and 2) if no mission events would occur in the same time period, the minimum amount of equipment and supply would be needed.

Inputs to this task are 1) system definitions from Screen III, 2) multimission system matrices from the previous task, and 3) ground rules which define the time overlaps among mission/conflict area combinations.

The various system combinations with their supporting data could be checked against the concurrency ground rules to determine the number of each type of vehicle and the amount of basing required to support all mission/conflict level combinations.

# Multimission System Definition

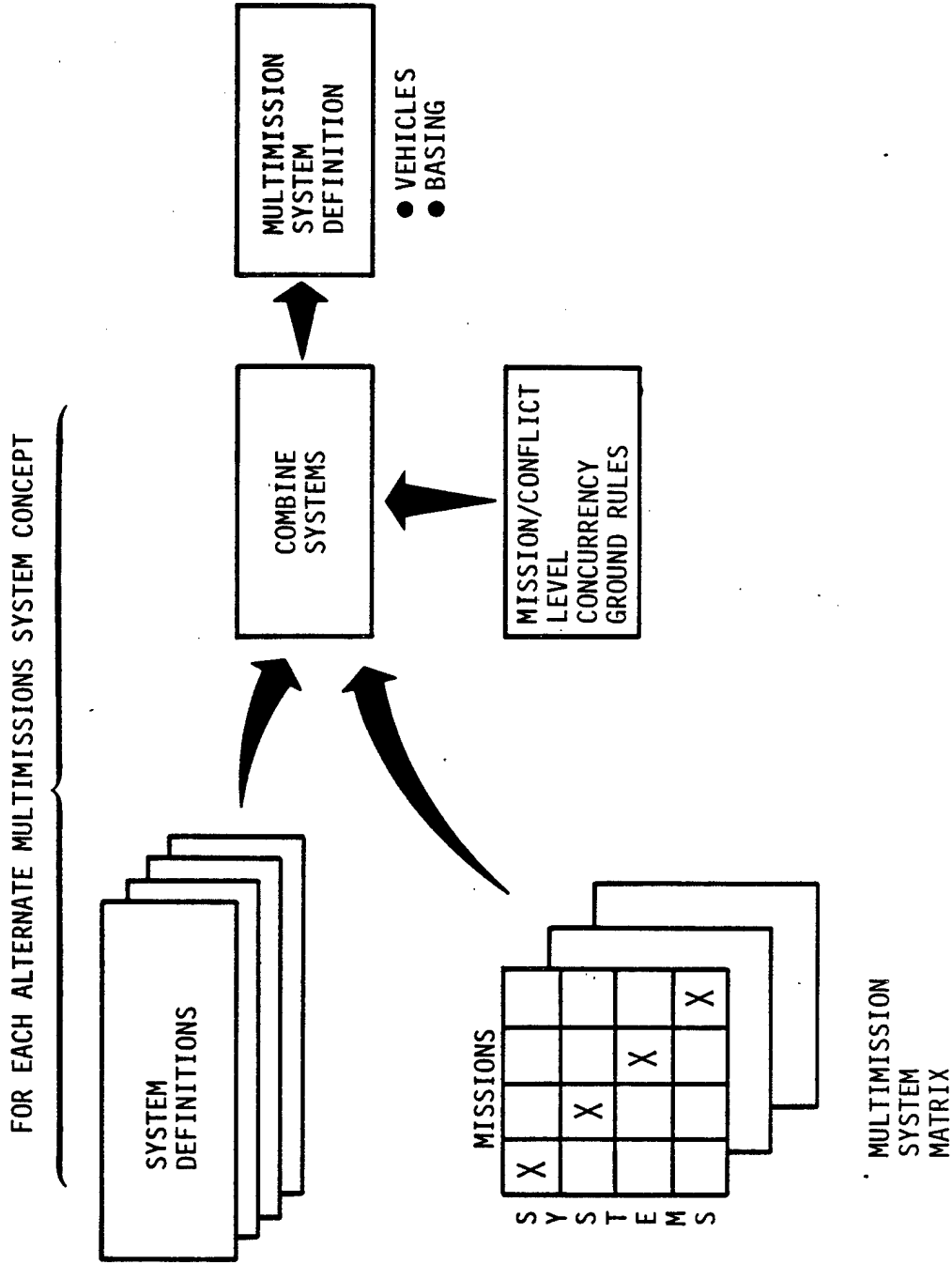

### COST EFFECTIVENESS EVALUATION

Each system combination, formed during the previous task (various combinations of TAV concepts and alternative systems), can satisfy the mission/conflict level needs. In other words, they all do the same job and the basis for a valid effectiveness comparison has been established. In this case, life cycle cost has been chosen as the measure of effectiveness.

Standard cost models could be used to generate TAV costs. Alternative systems costs should be obtained from official government sources.

The final output is the cost effectiveness comparison of TAV systems against alternate systems concepts.

# Cost Effectiveness Evaluation

FOR EACH ALTERNATE MULTIMISSION SYSTEM CONCEPT

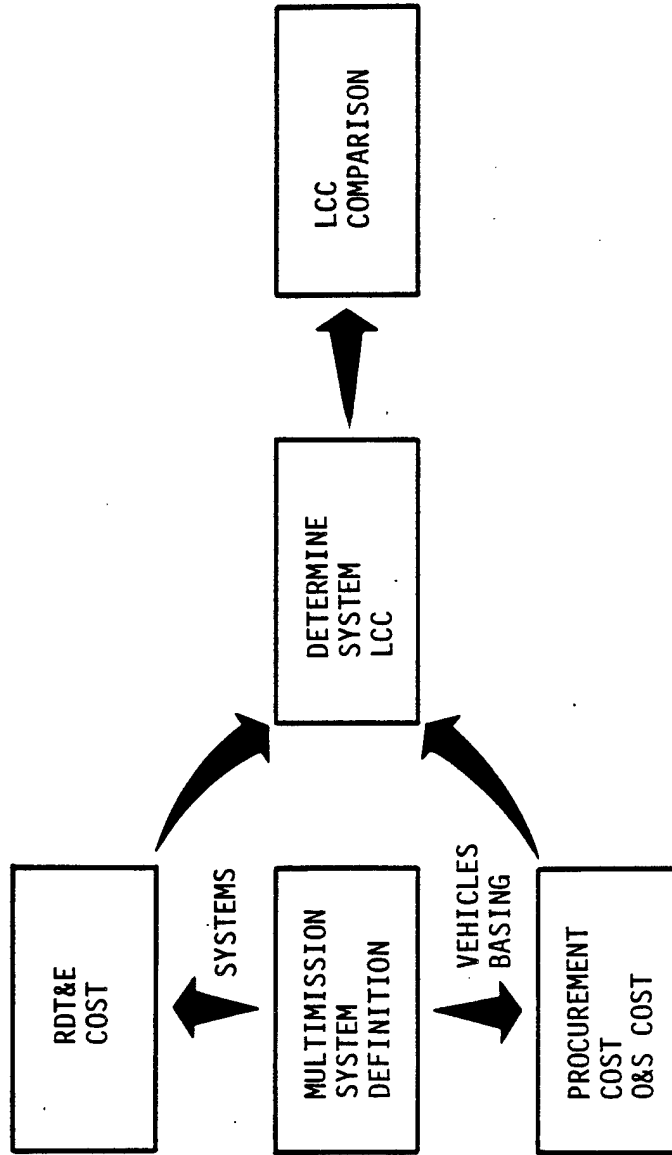



## EFFECTIVENESS EVALUATION

This diagram summarizes the effectiveness evaluation tasks.

Our recommendations regarding assignment of task responsibilities are as follows:

- o The systems contractor conduct all tasks for each of candidate alternate systems.
- o The aerospace subcontractor conducts those tasks indicated by the cross hatch for his TAV concept.
- o The systems contractor provide the input data base to the aerospace subcontractor.

# Effectiveness Evaluation

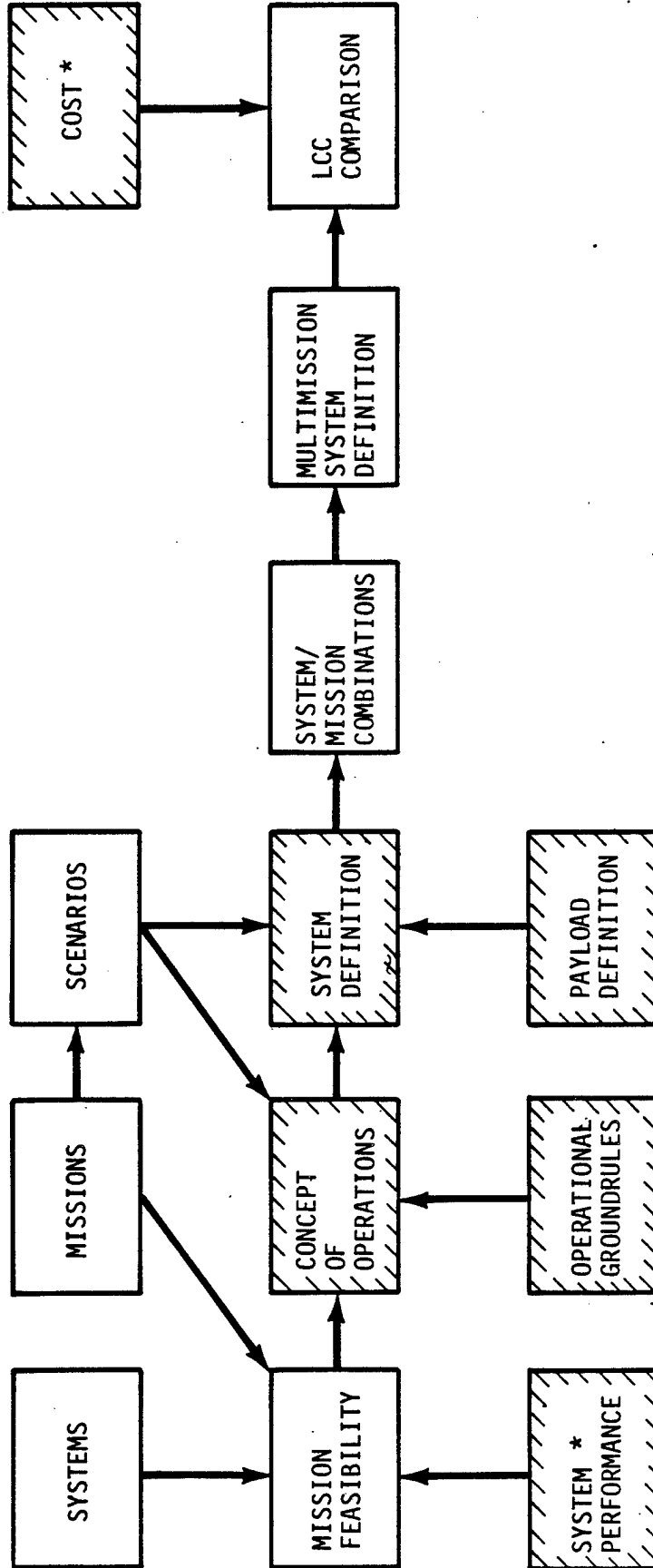

\* PARTIAL DATA SUBMITTED IN PHASE I

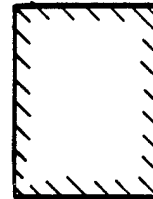

INPUTS REQUIRED FROM AEROSPACE CONTRACTORS  
FOR INDIVIDUAL TAV CONCEPTS

## RECOMMENDATIONS FOR PHASE II

The follow-on activity proposed for Concept B-1 is indicated on the adjacent chart. Boeing would propose to 1) support an integration contractor by providing the data required for an effectiveness comparison between the TAV Concept B-1 system and any other system to do a TAV mission, 2) prepare a preliminary system specification, 3) conduct system trade studies on the B-1 concept as indicated by the examples, and 4) develop a program plan schedule and the plan's associated fiscal year cost.

During the effort expended on this program a program designated "Two-Phase Program" was conceived. The idea of phasing the development and procurement of the DDT&E would allow demonstration of the highest risk component (the orbiter) without committing the USAF to the entire two-stage DDT&E costs. Yet this approach would provide early low payload capability with a sled launch orbiter in Phase I and in Phase II, a booster stage would be added to increase the payload to meet the requirements. Boeing would be glad to pursue this concept variation from Concept B-1 if during Battelle's concept evaluation it appears to be desirable.

BOEING PROPRIETARY

# Recommendations For Phase II

- CONCEPT B-1
- EFFECTIVENESS EVALUATION
  - INTEGRATION CONTRACTOR IDENTIFIES TAV MISSION AND SCENARIOS LEADING TO LCC TRADE
  - AEROSPACE CONTRACTOR PROVIDES CONCEPT DATA
    - SYSTEM PERFORMANCE
    - OPERATIONAL CONCEPT
    - PAYLOAD CONCEPT
    - SYSTEM COST
- TECHNOLOGY/CONFIGURATION ASSESSMENT /SYSTEM SPECIFICATION DEVELOPMENT
  - DEFINE AND DOCUMENT A PRELIMINARY SYSTEM SPECIFICATION
  - DEFINE/UPDATE SYSTEM AND SUBSYSTEM DEFINITION, e.g.,
    - IMPACT OF  $\epsilon = 200:1$  SSME ENGINE
    - UPGRADE PERFORMANCE  $I_{Sp} = 465.7$
  - IDENTIFY THE TECHNOLOGY RISK ITEMS
- PROGRAM PLAN
  - DEVELOP A PROGRAM SCHEDULE (IDENTIFY THE TECHNOLOGY TENT POLES)
  - DEVELOP PROGRAM COSTS BY FISCAL YEAR
- CONCEPT B-X (TWO PHASE PROGRAM)
  - DEVELOP PERFORMANCE, PROGRAM PLAN AND FISCAL YEAR COSTS - TWO PHASE PROGRAM
  - PHASE 1 - SSTO SLED LAUNCHED ORBITER
  - PHASE 2 - REPLACE SLED WITH BOOSTER AIRPLANE

## OPERATIONAL ASSESSMENT ROCKET POWERED AIRCRAFT

As with any advanced aerospace flight system, it is essential that its operational characteristics and capabilities undergo evaluation early in the conceptual phase. The rocket powered aircraft, being such a system, requires studies in the areas noted.

The interrelation between ground and flight operation need evaluation. Ground operation must be consistent with Air Force Military Operational Capabilities. Mission performance must also be assessed. This includes interrelationships between air vehicle, weapon, target and defensive systems.

The early assessment of flight handling characteristics will establish the ability of such systems to be flown by military personnel and or what system modifications will be necessary to permit such operation. The Take Off Support Running Gear is a subsystem element requiring early validation.

# OPERATIONAL ASSESSMENT ROCKET POWERED AIRCRAFT

D180-27669-4

395

## Areas of Concern

- Requirements for Operation of a New Type of Vehicle System (RPA)
  - Mission Payload
  - Operational Costs
  - Ground Support Facilities
  - Personnel and Training
  - Operational Time Lines
- Air Vehicle Handling Qualities
- Take-Off Support Vehicle Running Gear

## OPERATION ASSESSMENT

## ROCKET POWERED AIRCRAFT

The tasks and the major results expected from the tasks are shown for an early analysis of the Rocket Powered Aircraft operational characteristics. Each of these results are essential for an assessment of how such a system would be integrated into the overall Air Force Operational Plans. The tasks are consistent with those accomplished in the early evaluation of Advanced Air Force flight systems.

# Operational Assessment Rocket Powered Aircraft

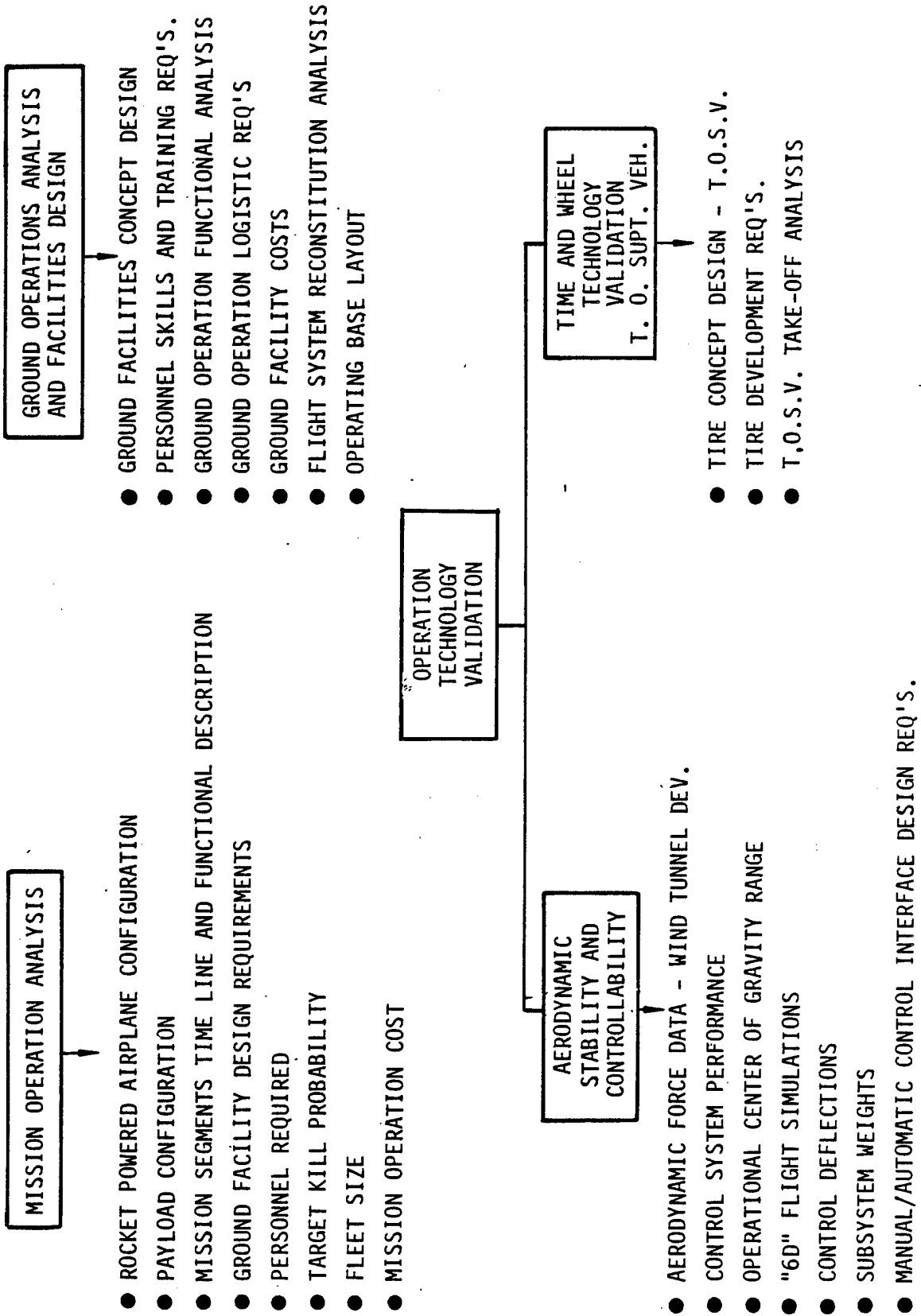



MISSION OPERATION ANALYSIS  
OPERATION ASSESSMENT--ROCKET POWERED AIRCRAFT

The network of events for both the flight mission analysis and the supporting ground operation and facility assessment are shown. It is intended that the output would provide specific design data and criteria for the next phase of Rocket Powered Aircraft development.

# Operation Assessment Rocket Powered Aircraft

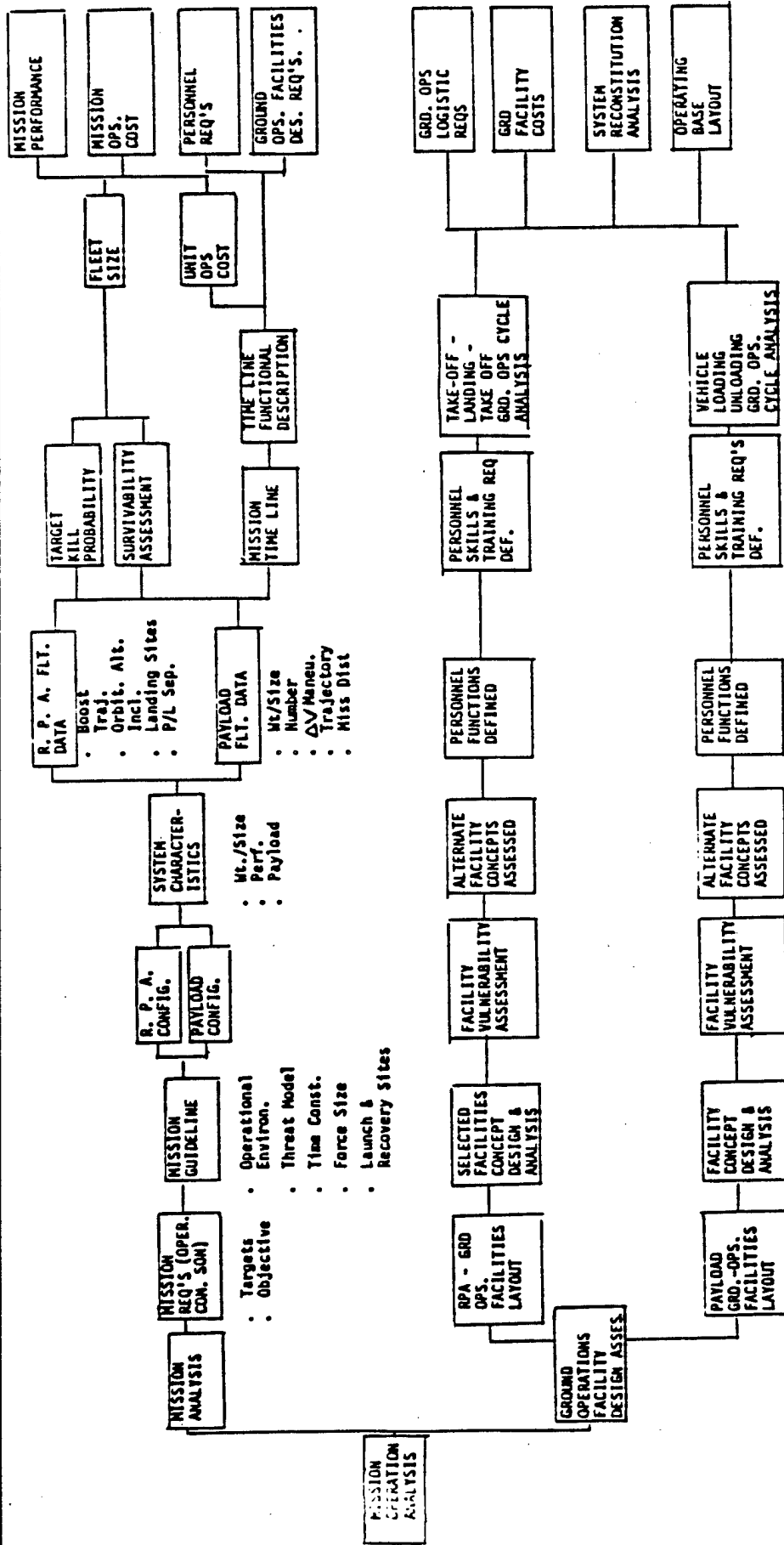

OPERATION TECHNOLOGY VALIDATION  
OPERATION ASSESSMENT--ROCKET POWERED AIRCRAFT

Two technology areas that are closely associated with system operation have been selected for early evaluation. The two areas will have strong feedback into the overall system aerodynamic configuration and the method for ground handling and take off. Early evaluation of these areas will be of major importance in providing proper direction for the next stage in Rocket Powered Aircraft development.

# Operation Assessment Rocket Powered Aircraft

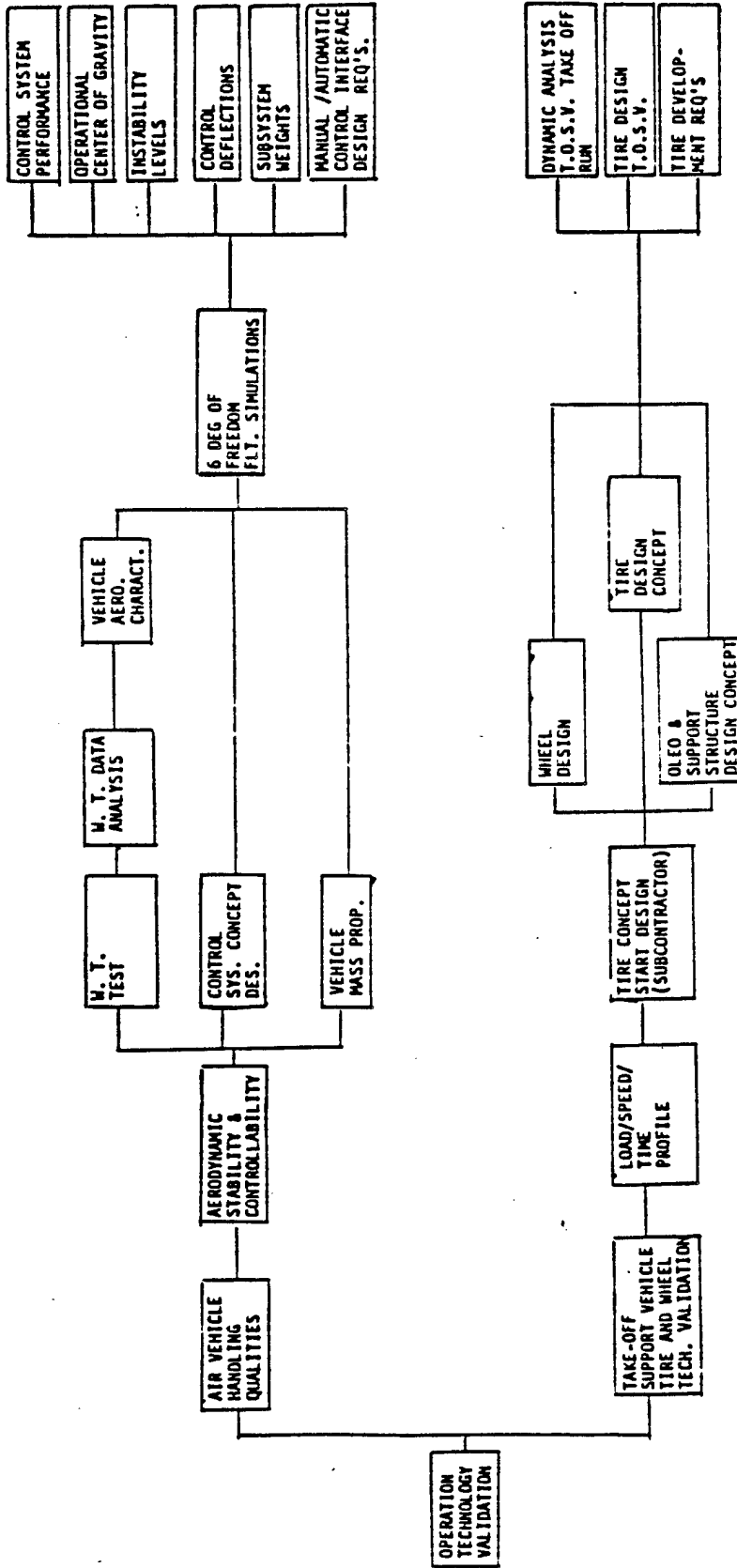

# Appendices

## Appendix A

- o TRANSATMOSPHERIC VEHICLE CONCEPT DEVELOPMENT AND EVALUATION  
SUBCONTRACTOR STATEMENT OF WORK

**TRANSATMOSPHERIC VEHICLE  
CONCEPT DEVELOPMENT AND EVALUATION  
SUBCONTRACTOR STATEMENT OF WORK**

**1.0 INTRODUCTION**

The USAF Aeronautical Systems Division has initiated a two phase program to evaluate the military utility of a Transatmospheric Vehicle (TAV). This work statement addresses the Phase 1 subcontractor effort and has primary focus on the definition of TAV concepts. In Phase 2, follow-on effectiveness analyses will evaluate TAV against alternate system concepts, both aeronautical and space-based, and assess the status of relevant TAV technologies.

Battelle's Columbus Laboratories (BCL) will provide the integration function during Phase 1. This includes securing subcontractor support from several major aerospace corporations to develop the TAV design concepts and to support the development of a Phase 2 program plan. From the concepts provided by the subcontractors, two to four will be recommended by Battelle and selected by the Air Force as candidates for Phase 2 studies based upon a set of selection criteria to be defined.

Battelle recognizes that the TAV program is highly competitive and represents a potentially high payoff to the aerospace hardware contractors. Battelle therefore assures that all information provided by the subcontractor during this effort will be given only to the U.S. Air Force.

**2.0 SCOPE**

The TAV concepts shall be designed to perform multimissions including strategic offense/defense, global force projection, tactical interdiction, and reconnaissance/surveillance in the post-1995 time frame. They shall be capable of weapon delivery, primarily against terrestrial targets, but secondarily, their potential for low Earth orbit ASAT/DSAT operations shall be considered in the design.

Baseline operational requirements include:

- (1) Manned Flight Operation
- (2) Global Range
- (3) Sortie Operations
- (4) Rapid Response
- (5) Flexible Basing
- (6) Horizontal Take Off and Landing
- (7) Launch and Landing Operations in Adverse Weather.

The TAV shall be designed to operate from main operating bases but shall be capable of recovery at secondary bases.

CONTRACT INST. ABST.  
REPRODUCTION PERMITTED

Design goals include:

- (1) Response time—5 minute launch (from alert status)
- (2) Turn around time—consistent with 2 missions/day
- (3) Fully reusable system
- (4) Single stage (ground launched)
- (5) Baseline payload—20,000 pounds to low polar orbit
- (6) Maximum on-orbit stay of a few orbits.

### 3.0 BACKGROUND

During 1982, a number of TAV activities were initiated by ASD, including a TAV Brainstorming Seminar, a Futurists Conference, and a TAV Conference. The latter was jointly sponsored with Space Division. In this conference, both government and industry participants presented their past, current, and proposed investigations in the areas of missions, vehicle design, and technology.

The consensus of the TAV conference was that the TAV will provide a new dimension in aerospace operations. It will provide the first truly military operations capability of man in space and could enable us to exploit the 100,000 to 500,000 ft altitude regime for certain missions. From an overall viewpoint, the TAV is an aerospace vehicle which could conduct "airplane-type" operations. That is, it will be a reusable sortie-type vehicle capable of all azimuth, on-demand launch and omni-directional encounter of threats. It would operate from current main operating bases and take advantage of conventional logistics concepts. A cost effective TAV would have reliability, availability, and reusability similar to aircraft and be multimission capable.

In summary, the TAV in the post-1995 time frame could provide the USAF with an unparalleled capability to meet the needs for flexibility, global range, and rapid response identified in the AF 2000 study. The Air Force Systems Command (AFSC) has also identified future roles for the TAV in the AFSC Space Plan published in December 1982.

### SUBCONTRACTOR TASKS

#### Task A. Provide Existing TAV Related Information

The subcontractor shall provide Battelle information related to TAV concepts, missions and potential threats in the post-1995 time frame that currently exist within the subcontractor's organization. The total conflict spectrum shall be considered from lower level (terrorism, insurgency) through theater (conventional, nuclear) to strategic (limited, central nuclear, prolonged). This information shall be provided in the form of a briefing to Battelle during the second week of the contract at the subcontractor's facility. Copies of all vugraphs from the briefing and supporting material such as reports and white papers



shall also be provided. Additionally, information concerning performance codes related to TAV shall be provided.

### Task B. TAV Concept Development

The subcontractor shall develop at least two (2) TAV concepts which can meet the operational requirements indicated under the scope statement. Battelle will expand these requirements and provide you with the following:

- (1) Preliminary TAV Requirements Definition—May 9, 1983
- (2) Updated TAV Requirements Document—June 1, 1983
- (3) Final TAV Requirements Document—July 1, 1983.

The proposed TAV systems should have a technical basis in the contractor/subcontractor's own government sponsored or IRAD activities, or be derived from government sponsored contracted or internal studies [Aeronautical Systems Division/Air Force Wright Aeronautical Laboratories (ASD/AFWAL), Air Force Space Division (AFSD), NASA, DARPA, etc]. The TAV concepts shall meet the stated design goals, and subcontractor rationale shall be presented for variations from these goals, if they can't be met.

In particular, the subcontractor shall address at a minimum\* design advantages/penalties associated with:

- (1) Fully reusable vs. partially reusable systems
- (2) Single stage (ground launched) vs. two-stage: TAV + carrier aircraft (air launched) systems
- (3) Payload variations (range 5,000 to 30,000 pounds).

If two-stage TAV systems are proposed, the subcontractor shall address at a minimum\*:

- (1) Supersonic vs. subsonic launch
- (2) Current vs. new design first stage carrier aircraft
- (3) Alternate military missions for the first stage carrier aircraft.

Design drivers associated with response time and turn around time goals shall be identified.

Specifically, the subcontractor shall define at least two basepoint TAV configurations by (1) describing the design and sizing criteria, (2) providing the performance over the entire flight envelope and a group weight statement, and (3) providing a three-view external arrangement drawing, an inboard profile, and a structural diagram of the TAV.

---

\*Battelle may add to this list during the first month of the study.

For two-stage systems, a three-view external arrangement drawing, an inboard profile, and a structural diagram shall be provided of the first stage carrier aircraft and an installation drawing shall be provided showing the TAV mated to the first stage aircraft.

Other pertinent TAV characteristics, such as observables to the degree necessary to support a Phase 2 effectiveness analysis, shall also be provided.

Using a SAC base as a baseline, the subcontractor shall describe operating base logistics and support capabilities applicable to TAV and identify additional requirements peculiar to the TAV (i.e., vs. aircraft baseline).

The subcontractors shall also provide ROM costs for their concepts including development, investment and O&M costs.

The subcontractor shall rank order his concepts based upon technical risk including estimated technology costs, projected availability dates, and schedule sensitivities.

#### Task C. Provide Input to the Phase 2 Program Plan

The subcontractor shall provide Battelle inputs to the Phase 2 Program Plan, which will include TAV effectiveness analysis and technology assessment. The effectiveness analysis will compare the selected Phase 1 TAV concepts against alternative aeronautical systems and space-based concepts in the mission/threat environment of the post-1995 time frame. The technology assessment will determine current status and projected availability dates of critical TAV technologies. Additionally, the subcontractor shall provide their best projection of technology development and system development schedules and costs.

#### REPORTS, DATA, AND OTHER DELIVERABLES

The subcontractor shall provide three briefings. The first briefing shall occur during the second week of the contract at the subcontractor's facility to satisfy the requirements of Task A. The second briefing shall occur approximately 2 months after authorization at Battelle and shall provide a review of the subcontractor's progress to date. The third and final briefing shall occur approximately 3 months after authorization at the subcontractor's facility. At the final briefing, the subcontractor shall (1) present his final design concepts and inputs for the Phase 2 Program Plan, and (2) provide a draft technical report summarizing his activities. The subcontractor shall provide a final technical report one month after the final briefing. The subcontractor shall provide 5 numbered copies of all briefing material at each briefing.

Additionally, monthly progress and cost reports (including man hours) shall be provided by the subcontractor to Battelle no later than the twelfth day of each month. The deliverables are summarized in Table 1. The exact dates for submission will be mutually agreed upon by Battelle and the subcontractor, after contract authorization.

CONTRACT DOCUMENT  
REPRODUCED AS FURNISHED

TABLE 1. SUBCONTRACT DELIVERABLES

<u>Item</u>	<u>Delivery Date</u>
Task A Briefing, Briefing Materials, and Supporting Documentation	2 Weeks After Authorization
Midterm Briefing and Briefing Materials	2 Months After Authorization
Final Briefing and Briefing Materials	3 Months After Authorization
Draft Final Report	3 Months After Authorization
Final Report	4 Months After Authorization
Progress and Cost Reports	Monthly, No later than the Twelfth of each month

CONTRACT INSTRUMENT  
REPRODUCTION PROHIBITED

# Appendix B

o POST OPTIMIZED PERFORMANCE TRAJECTORY FOR CONCEPT B-1

POST OPTIMIZED PERFORMANCE

Optimization of the trajectory was accomplished with POST (Program to Optimize Simulated Trajectories). Performance improvements of 7% and 15% for east and polar inclinations, respectively, have been realized for once-around orbits. The goal mission, 20,000-lb once-around at 90° inclination, has been exceeded by 3,000 lb through trajectory optimization, as shown in the figure. It is expected that comparable performance improvements for missions A through D will be realized through trajectory optimization.

The accompanying pages include POST input and output files for the goal mission.

# POST Optimized Performance

MODEL 896-111

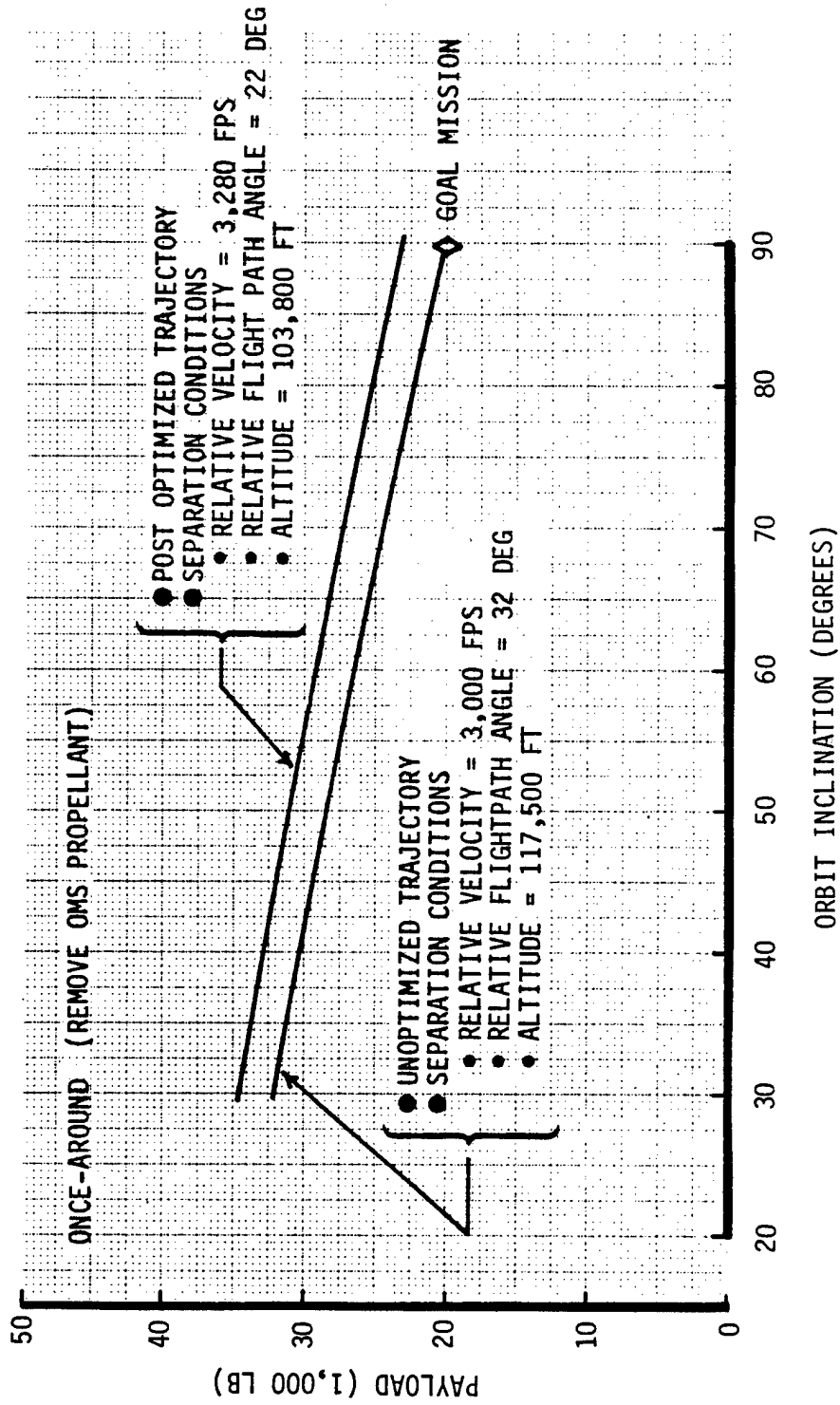

BOEING PROPRIETARY

P O S T - MMC 3D TARGETING AND OPTIMIZATION PROGRAM. REVISED 030177 , PROBLEM NO. 1

```

P$SEARCH
C*****
C      POST INPUT TO OPTIMIZE A
C      COMPLETE TRAJECTORY INCLUDING
C      BURNOUT VELOCITY ALTITUDE AND
C      FLIGHT PATH ANGLE FOR MODEL
C      896-111. THE INITIAL CONDITIONS
C      ARE:
C      VELR=864. FPS
C      ALT=30000. FT
C      GAMMAR=0. DEG
C
C      THE FINAL CONDITIONS ARE:
C      VELI=25800. FPS
C      ALT=303800. FT
C      GAMMAI=0. DEG
C
C*****
SRCMH=4, IPRO=-1, MAXITR=0, CONEPS=89.8,
OPT=1, OPTVAR=6HWEIGHT, OPTPH=18,
MOP1=8.E-6,
NINDV=19,
INDVR=6HPITPC1,6X6HPITPC2,6HPITPC1,11X6HPITPC2,
INDPH=1,1,2,3,4,5,6,7,7,8,9,10,11,12,13,14,15,16,17,
U=5.45222989E+00,5.13992095E-01,2.61467453E-03,-6.28032588E-02,5.8022975E-01,
1.94310746E-01,1.722164E-01,4.05093425E+01,-1.17062469E-01,-1.99208349E-01,
-1.66535835E-01,-1.7713759E-01,1.98775627E-01,-1.96652417E-01,-1.1869776E-01,
-1.54672196E-01,-1.37675934E-01,-1.25816077E-01,-1.03371544E-01,
PERT=4.90014312E-3,1.97361246E-4,1.65251009E-4,1.25594999E-4,
6.10792378E-5,4.67073255E-5,1.03586924E-4,9.61975001E-5,9.79127925E-6,
6.82400189E-6,7.20598854E-6,5.78031845E-6,6.29379138E-6,5.63087339E-6,
3.86411647E-6,5.14848770E-6,8.96711049E-6,5.57266604E-5,2.59188662E-3,
NDEPV=4,
DEPVR=6HALTIT0,6HVELI ,6HGAMMAR,6HXMAX1 ,
DEPVAL=303800.,25800., 0.0, 1050.,
DEPTL= 100., 1., 0.01, 1.0,
IDEPVR= 0, 0, 0, 1,
$
P$GENDAT EVENT=1,
TITLE=0H*MODEL 896-111 LOWER STAGE *,
NPC(2)=1,4,2,ALTI=30000.,VELR=864.,
LONG=279.6, GCLAT=32., AZVELR=-2.45,
AZL=-2.45,
MAXTIM=1000., IGUID(1)=2, IGUID(4)=1, NPC(8)=2, 1, NPC(16)= 1, NPC(21)=0,
NPC(25)= 3, IGUID(13)= 2,
ALTMAX=2.E6, FESN=18, PINC=30.,
NPC(12)=1, AZREF=-2.45, LATREF=32., LONREF=279.6,
NEHG=3,
MPROPI=309300., WPLD=577500., MGTSG=607500.,
MONX(1)=4HDYNP, MONY(1)=4HTIME, MONX(2)=5HALPHA, MONY(2)=4HTIME,
SREF=9000,
NPC(27)=1, IMPF(1)=1,0,0,
PRINT(91)=6HPMPROP,5HPMDOT,4HTHR1,4HTHR2,4HTHR3,

```

BOEING PROPRIETARY

\$ SHXMAX1,5HYXMX1,6HTIMRF1,5HXMAX2,5HYXMX2,5HPSTOP,  
 P\$TBLMLT TVC1M=8.,TVC2M=2.,TVC3M=4.,  
 WD1M=8.,WD2M=2.,WD3M=4.,  
 AE2M=2.,AE3M=4.,  
 P\$TAB TABLE=6HTVCIT ,2, 6HALTITO, 6HMACH ,11,11.8x1,  
 6,  
 30000.,18331.3,35000.,14850.2,40000.,11653.7,45000.,9078.7,  
 50000.,6433.0,55000.,4502.7,60000.,0.,65000.,0.,  
 70000.,0.,71000.,0.,120000.,0.,  
 8,  
 30000.,22268.5,35000.,18058.9,40000.,14219.3,45000.,11120.8,  
 50000.,7986.9,55000.,5684.0,60000.,0.,65000.,0.,  
 70000.,0.,71000.,0.,120000.,0.,  
 1.0,  
 30000.,27677.0,35000.,22539.4,40000.,17835.8,45000.,13991.1,  
 50000.,10032.8,55000.,7125.1,60000.,0.,65000.,0.,  
 70000.,0.,71000.,0.,120000.,0.,  
 1.2,  
 30000.,31985.4,35000.,27835.1,40000.,22144.2,45000.,17234.3,  
 50000.,12694.1,55000.,9307.1,60000.,0.,65000.,0.,  
 70000.,0.,71000.,0.,120000.,0.,  
 1.4,  
 30000.,37325.0,35000.,32322.6,40000.,25485.0,45000.,19624.5,  
 50000.,14554.3,55000.,10754.9,60000.,7267.4,65000.,0.,  
 70000.,0.,71000.,0.,120000.,0.,  
 1.6,  
 30000.,42365.2,35000.,36999.4,40000.,29058.7,45000.,22211.1,  
 50000.,16670.1,55000.,12483.3,60000.,8685.6,65000.,5937.9,  
 70000.,2660.5,71000.,0.,120000.,0.,  
 1.8,  
 30000.,48792.1,35000.,42466.3,40000.,33406.5,45000.,25612.8,  
 50000.,19335.7,55000.,14576.9,60000.,10358.9,65000.,7277.7,  
 70000.,4096.4,71000.,0.,120000.,0.,  
 2.0,  
 30000.,55988.6,35000.,48761.6,40000.,38435.1,45000.,29506.9,  
 50000.,22370.8,55000.,16943.5,60000.,12251.7,65000.,8791.7,  
 70000.,5264.6,71000.,0.,120000.,0.,  
 2.2,  
 30000.,63949.1,35000.,55856.7,40000.,44041.9,45000.,33837.5,  
 50000.,25698.7,55000.,19488.0,60000.,14215.6,65000.,10307.5,  
 70000.,6357.5,71000.,0.,120000.,0.,  
 2.3,  
 30000.,0.,35000.,0.,40000.,0.,45000.,0.,50000.,0.,55000.,0.,60000.,0.,  
 65000.,0.,70000.,0.,71000.,0.,120000.,0.,  
 5.0,  
 30000.,0.,35000.,0.,40000.,0.,45000.,0.,50000.,0.,55000.,0.,60000.,0.,  
 65000.,0.,70000.,0.,71000.,0.,120000.,0.,  
 P\$TAB TABLE=6HWDIT ,2, 6HALTITO, 6HMACH ,11,11.8x1,  
 6,  
 30000.,12.1678,35000.,9.8654,40000.,7.7887,45000.,6.1206,  
 50000.,4.6138,55000.,3.4708,60000.,1.,65000.,1.,  
 70000.,1.,71000.,1.,120000.,1.,  
 8,  
 30000.,14.3231,35000.,11.5904,40000.,9.1516,45000.,7.1914,  
 50000.,5.4334,55000.,4.0972,60000.,1.,65000.,1.,  
 70000.,1.,71000.,1.,120000.,1.,  
 1.0,



30000.,17.2326,35000.,13.9526,40000.,11.0384,45000.,8.6785,  
 50000.,6.5019,55000.,4.8609,60000.,1.,65000.,1.,  
 70000.,1.,71000.,1.,120000.,1.,  
 1.2,  
 30000.,19.8621,35000.,16.8210,40000.,13.3358,45000.,10.4126,  
 50000.,7.8881,55000.,5.9668,60000.,1.,65000.,1.,  
 70000.,1.,71000.,1.,120000.,1.,  
 1.4,  
 30000.,23.0947,35000.,19.5055,40000.,15.3545,45000.,11.8893,  
 50000.,9.0156,55000.,6.8323,60000.,4.9338,65000.,1.,  
 70000.,1.,71000.,1.,120000.,1.,  
 1.6,  
 30000.,26.2961,35000.,22.4209,40000.,17.6049,45000.,13.5489,  
 50000.,10.3122,55000.,7.8470,60000.,5.7131,65000.,4.1334,  
 70000.,2.3274,71000.,1.,120000.,1.,  
 1.8,  
 30000.,30.1500,35000.,25.7574,40000.,20.2389,45000.,15.6023,  
 50000.,11.8806,55000.,9.0458,60000.,6.6269,65000.,4.8275,  
 70000.,3.0352,71000.,1.,120000.,1.,  
 2.0,  
 30000.,34.4403,35000.,29.5072,40000.,23.2317,45000.,17.9006,  
 50000.,13.6463,55000.,10.3919,60000.,7.6574,65000.,5.6194,  
 70000.,3.5864,71000.,1.,120000.,1.,  
 2.2,  
 30000.,39.2136,35000.,33.7547,40000.,26.5719,45000.,20.4813,  
 50000.,15.6194,55000.,11.8929,60000.,8.7702,65000.,6.4363,  
 70000.,4.1402,71000.,1.,120000.,1.,  
 2.3,  
 30000.,1.0,35000.,1.0,40000.,1.0,45000.,1.0,50000.,1.0,50000.,1.0,  
 55000.,1.0,60000.,1.0,65000.,1.0,70000.,1.0,71000.,1.0,  
 120000.,1.0,  
 5.0,  
 30000.,1.0,35000.,1.0,40000.,1.0,45000.,1.0,50000.,1.0,50000.,1.0,  
 55000.,1.0,60000.,1.0,65000.,1.0,70000.,1.0,71000.,1.0,  
 120000.,1.0,  
 P\$TAB TABLE=6HAEIT ,0.0.,/EXIT AREA FOR AIRBREATHER BACK PRES LOSSES  
 P\$TAB TABLE=6HTVC2T ,0.530200.,/112 SSME TVAC  
 P\$TAB TABLE=6HWD2T ,0.1138.5012,/112 SSME ISPV=465.7 SEC  
 P\$TAB TABLE=6HAE2T ,0.87.,/EXIT AREA SSME EXPANDED 150:1  
 P\$TAB TABLE=6HTVC3T ,0.34500.,/ADV RL-10'S TVAC  
 P\$TAB TABLE=6HWD3T ,0.80.0650,/ADV RL-10'S ISPV=430.9 SEC  
 P\$TAB TABLE=6HAE3T ,0.6.2.,/ EXIT AREA FOR ADV RL-10  
 P\$TAB TABLE=3HCLT,2.5HALPHA,4HMACH,7.9,8x1,/MODEL 896-111 BOOST W/ ORBITER IN PL  
 0.2,  
 -2.,0.,0.,120,2.5.,270,5.,419,10.,718,15.,1.017,25.,1.615,  
 0.8,  
 -2.,0.,0.,132,2.5.,297,5.,462,10.,792,15.,1.122,25.,1.782,  
 0.9,  
 -2.,0.,0.,138,2.5.,311,5.,483,10.,828,15.,1.173,25.,1.863,  
 1.1,  
 -2.,0.,0.,148,2.5.,333,5.,518,10.,888,15.,1.258,25.,1.998,  
 1.2,

-2.,0.,0.,.134,2.5.,.302,5.,.469,10.,.804,15.,1.139,25.,1.809,  
 1.5,  
 -2.,0.,0.,.107,2.5.,.241,5.,.375,10.,.642,15.,.910,25.,1.446,  
 2.0,  
 -2.,0.,0.,.081,2.5.,.181,5.,.284,10.,.480,15.,.689,25.,1.107,  
 2.5,  
 -2.,0.,0.,.066,2.5.,.149,5.,.231,10.,.396,15.,.561,25.,.891,  
 3.0,  
 -2.,0.,0.,.055,2.5.,.124,5.,.194,10.,.332,15.,.471,25.,.749,  
 \$

\$TAB TABLE=6HCDT ,2.5HALPHA,4HMACH,7.9,8X1,/MODEL 896-111 BOOST W/ ORBITER IN

0.2, .0116,0.,.0129,2.5.,.0216,5.,.0315,10.,.1159,15.,.2300,25.,.4582,  
 0.8,  
 -2.,.0090,0.,.0106,2.5.,.0168,5.,.0313,10.,.1250,15.,.2400,25.,.4700,  
 0.9,  
 -2.,.0085,0.,.0099,2.5.,.0164,5.,.0330,10.,.1300,15.,.2450,25.,.4750,  
 1.1,  
 -2.,.0525,0.,.0560,2.5.,.0756,5.,.1125,10.,.2500,15.,.3000,25.,.4000,  
 1.2,  
 -2.,.0504,0.,.0542,2.5.,.0723,5.,.1068,10.,.3000,15.,.3500,25.,.4500,  
 1.5,  
 -2.,.0451,0.,.0479,2.5.,.0631,5.,.0915,10.,.1906,15.,.2500,25.,.4100,  
 2.0,  
 -2.,.0391,0.,.0422,2.5.,.0535,5.,.0745,10.,.1423,15.,.2300,25.,.4054,  
 2.5,  
 -2.,.0323,0.,.0351,2.5.,.0459,5.,.0650,10.,.1295,15.,.2100,25.,.3710,  
 3.0,  
 -2.,.0221,0.,.0246,2.5.,.0350,5.,.0540,10.,.1138,15.,.1999,25.,.3721,  
 ENDPHS=1,  
 \$

\$GENDAT EVENT=2, CRITR=6HWEICON ,VALUE=52000.,  
IGUID(4)=0,  
ENDPHS=1,  
\$

\$GENDAT EVENT=3, CRITR=6HWEICON ,VALUE=104000.,  
ENDPHS=1,  
\$

\$GENDAT EVENT=4, CRITR=6HWEICON , VALUE=156000.,  
ENDPHS=1,  
\$

\$GENDAT EVENT=5, CRITR=6HWEICON ,VALUE=208000.,  
ENDPHS=1,  
\$

\$GENDAT EVENT=6, CRITR=6HWEICON ,VALUE=260000.,  
ENDPHS=1,  
\$

\$GENDAT EVENT=7, CRITR=6HWEICON ,VALUE=309300.,  
 TITLE=0H\*MODEL 896-111 UPPER STAGE \*,  
 NPC(9)=1, NPC(21)=1, NPC(27)=0, IGUID(4)=1,  
 DTIME(1)=1., TIMRF(1)=0.,  
 NENG=2  
 MPROFI=459114., ISPV=430.9, 465.7, MPLD=27592., MGTSG=549908.,  
 SREF=2510.,  
 \$

\$TABLM TVCIM=4.,TVC2M=1.,AEIM=4.,AE2M=1.,

\$TAB TABLE=6HTVCIT ,0.34500.,/ADV-RL-10'S

\$TAB TABLE=6HAEIT ,0.6.2, /ADV-RL-10'S

```

$ P$TAB TABLE=6HTVC2T , 0,530200.,/112 SSME TVAC
$ P$TAB TABLE=6HAE2T , 0,87., /SSME EXPANDED 150:1
$ P$TAB TABLE=6HCDT , 2,6HMACH ,6HALPHA ,7,8,8*1,/ MODEL 896-111 ORBITER
-25.,
2.5.,.408,2.93,.372,4.1.,.319,6.81.,.278,10.36.,.264,15.,.259,30.,.257,
-10.,
2.5.,.118,2.93,.105,4.1.,.087,6.81.,.072,10.36.,.066,15.,.063,30.,.062,
-5.,
2.5.,.096,2.93,.087,4.1.,.074,6.81.,.063,10.36.,.059,15.,.057,30.,.056,
0.,
2.5.,.078,2.93,.070,4.1.,.059,6.81.,.050,10.36.,.047,15.,.045,30.,.044,
5.,
2.5.,.084,2.93,.076,4.1.,.063,6.81.,.052,10.36.,.048,15.,.046,30.,.045,
10.,
2.5.,.118,2.93,.105,4.1.,.087,6.81.,.072,10.36.,.066,15.,.063,30.,.062,
25.,
2.5.,.408,2.93,.372,4.1.,.319,6.81.,.278,10.36.,.264,15.,.259,30.,.257,
40.,
2.5.,.994,2.93,.928,4.1.,.835,6.81.,.771,10.36.,.753,15.,.746,30.,.743,
$ P$TAB TABLE=6HCLT , 2,6HMACH ,6HALPHA ,7,8,8*1,/ MODEL 896-111 ORBITER
-25.,
2.5.,-.710,2.93,-.644,4.1,-.546,6.81,-.469,10.36,-.442,15.,-.433,30.,-.428,
-10.,
2.5.,-.25,2.93,-.220,4.1,-.173,6.81,-.131,10.36,-.113,15.,-.105,30.,-.100,
-5.,
2.5.,-.150,2.93,-.136,4.1,-.112,6.81,-.090,10.36,-.080,15.,-.076,30.,-.072,
0.,
2.5.,-.024,2.93,-.024,4.1,-.024,6.81,-.023,10.36,-.022,15.,-.021,30.,-.021,
5.,
2.5.,.108,2.93,.093,4.1.,.069,6.81.,.048,10.36.,.039,15.,.035,30.,.032,
10.,
2.5.,.25,2.93,.220,4.1.,.173,6.81.,.131,10.36.,.113,15.,.105,30.,.100,
25.,
2.5.,.710,2.93,.644,4.1.,.546,6.81.,.469,10.36.,.442,15.,.433,30.,.428,
40.,
2.5.,.1.084,2.93,1.009,4.1.,.903,6.81.,.830,10.36.,.809,15.,.802,30.,.798,
ENDPHS=1,
$ P$GENDAT EVENT=8, CRITR=6HTIMRF1 , VALUE=10.,
IGUID(4)=0,
ENDPHS=1,
$ P$GENDAT EVENT=9, CRITR=6HTIMRF1 , VALUE=25.,
ENDPHS=1,
$ P$GENDAT EVENT=10, CRITR=6HTIMRF1 , VALUE=40.,
NPC(7)=1, ASMAX=3.15,
ENDPHS=1,
$ P$GENDAT EVENT=11, CRITR=6HTIMRF1 , VALUE=60.,
ENDPHS=1,
$ P$GENDAT EVENT=12, CRITR=6HTIMRF1 , VALUE=80.,
ENDPHS=1,
$ P$GENDAT EVENT=13, CRITR=6HTIMRF1 , VALUE=105.,

```

BOEING PROPRIETARY

```
ENDPHS=1,  
$  
P$GENDAT EVENT=14, CRITR=6HTIMRF1 ,VALUE=150.,  
ENDPHS=1,  
$  
P$GENDAT EVENT=15, CRITR=6HTIMRF1 ,VALUE=200.,  
ENDPHS=1,  
$  
P$GENDAT EVENT=16, CRITR=6HTIMRF1 ,VALUE=260.,  
ENDPHS=1,  
$  
P$GENDAT EVENT=17, CRITR=6HTIMRF1 ,VALUE=300.,  
NPC(1)=2,  
ENDPHS=1,  
$  
P$GENDAT EVENT=18, CRITR=6HVELI ,VALUE=25800.,  
ENDPHS=1,  
ENDPRB=1,  
ENDJOB=1,  
$
```

MODEL 896-111 LOWER STAGE

INPUT UNITS = ENGLISH, OUTPUT UNITS = ENGLISH

INITIAL CONDITIONS

TIME = 0. TIME0 = 0.  
GCLAT = 3.2000000E+01 GDLAT = 3.2000000E+01 LONG = 2.79600000E+02 LONGI = 2.79600000E+02  
GCRAD = 2.09557410E+07 ALIIT0 = 3.00000000E+04  
VELR = 8.64000000E+02 GAMMAR = 0. AZVELR = -2.45000000E+00

PROGRAM TERMINATION PARAMETERS

FESN = 18.000 MAXTIM = 1.00000000E+03 ALTHIN = -5.00000000E+03 ALTMAX = 2.00000000E+06

THE LAUNCH PAD INERTIAL (L) FRAME IS DEFINED BY

LATL = 3.20000000E+01 LONL = 2.79600000E+02 AZL = -2.45000000E+00

ATTRACTING PLANET MODEL

RE = 2.09257410E+07 RP = 2.09257410E+07 OMEGA = 7.29211000E-05 MU = 1.40765390E+16  
J2 = 0. J3 = 0. J4 = 0.

BOEING PROPRIETARY

MODEL 896-111 LOWER STAGE

BEGIN PHASE 1.000

1962 U.S. STANDARD ATMOSPHERE MODEL

COMPUTE DOWN AND CROSS RANGE BASED ON RELATIVE GREAT CIRCLES

LATREF = 3.20000000E+01 LONREF = 2.79600000E+02 AZREF = -2.45000000E+00

AERODYNAMIC COEFFICIENTS SPECIFIED BY DRAG AND LIFT COEFFICIENTS

SREF = 9.00000000E+03 LREF = 1.00000000E+00 LREFY = 0.

PROPULSION CALCULATED FOR 3 ROCKET ENGINES

VEHICLE WEIGHT PARAMETERS

WGTSO = 6.07500000E+05 WPLD = 5.77500000E+05 WPROP = 3.09300000E+05 MJETT = 0.  
 GO = 3.21740000E+01

NUMBER OF INTEGRALS FOR THIS PHASE = 17

INTEGRATION SCHEME = FOURTH ORDER RUNGE-KUTTA

DT = 1.00000000E+00 PINC = 3.00000000E+01

USE RELATIVE YAW, PITCH, AND ROLL COMMANDS

ROLPC = 0.  
 PITPC = 5.45222989E+00, 5.13992095E-01, 0.  
 YAWPC = 0.  
 YAWI = 0.  
 PITI = 0.  
 ROLI = 0.  
 YAWR = 0.  
 PIR = 0.  
 ROLR = 0.  
 DYAM = 0.  
 DPITCH = 0.  
 DROLL = 0.  
 DESN = 0.  
 DESN = 0.

THE NEXT EVENT TO OCCUR WILL BE ONE OF THE FOLLOWING

ESN = 2.000 TYPE = PRIMARY CRITR = WEICON VALUE = 5.20000000E+04  
 TOL = 1.00000000E-06 MDL = 1

TABLES AND MULTIPLIERS FOR THIS PHASE

CDT = 1.00000000E+00 CLT = 1.00000000E+00 TVC1T = 8.00000000E+00 TVC2T = 2.00000000E+00 TVC3T = 4.00000000E+00  
 WDT = 8.00000000E+00 WD2T = 2.00000000E+00 WD3T = 4.00000000E+00 AE1T = 1.00000000E+00 AE2T = 2.00000000E+00  
 AE3T = 4.00000000E+00

PROGRAM CONTROL FLAGS

( 1 ) = 0 NPC ( 2 ) = 1 NPC ( 3 ) = 4 NPC ( 4 ) = 2 NPC ( 5 ) = 2 NPC ( 6 ) = 0 NPC ( 7 ) = 0  
 ( 8 ) = 2 NPC ( 9 ) = 1 NPC ( 10 ) = 0 NPC ( 11 ) = 0 NPC ( 12 ) = 1 NPC ( 13 ) = 0 NPC ( 14 ) = 0  
 ( 15 ) = 0 NPC ( 16 ) = 1 NPC ( 17 ) = 0 NPC ( 18 ) = 0 NPC ( 19 ) = 1 NPC ( 20 ) = 0 NPC ( 21 ) = 0  
 ( 22 ) = 0 NPC ( 23 ) = 0 NPC ( 24 ) = 0 NPC ( 25 ) = 3 NPC ( 26 ) = 0 NPC ( 27 ) = 1 NPC ( 28 ) = 0  
 ( 29 ) = 0 NPC ( 30 ) = 0 NPC ( 31 ) = 0 NPC ( 32 ) = 0 NPC ( 33 ) = 0 NPC ( 34 ) = 0 NPC ( 35 ) = 0

GUIDANCE CONTROL FLAGS

IGUID ( 1 ) = 2 IGUID ( 2 ) = 0 IGUID ( 3 ) = 0 IGUID ( 4 ) = 1 IGUID ( 5 ) = 1 IGUID ( 6 ) = 0 IGUID ( 7 ) = 0  
 ( 8 ) = 0 IGUID ( 9 ) = 0 IGUID ( 10 ) = 0 IGUID ( 11 ) = 0 IGUID ( 12 ) = 2 IGUID ( 13 ) = 0 IGUID ( 14 ) = 0  
 ( 15 ) = 0 IGUID ( 16 ) = 0 IGUID ( 17 ) = 0 IGUID ( 18 ) = 0 IGUID ( 19 ) = 0 IGUID ( 20 ) = 0 IGUID ( 21 ) = 0  
 ( 22 ) = 0 IGUID ( 23 ) = 0 IGUID ( 24 ) = 0 IGUID ( 25 ) = 0

BOEING PROPRIETARY

PAGE 6  
PROBLEM NO. 1

MODEL 896-111 LOWER STAGE

++WARNING++ GENTAB(TVCIT ), XS= 3.00000000E+04, TABLE LIMIT = 3.00000000E+04  
++WARNING++ GENTAB(WDIT ), XS= 3.00000000E+04, TABLE LIMIT = 3.00000000E+04

TIME	0.	TIMES	0.	TDURP	0.	*** PHASE	1.000 ***	PRES	8.90687151E-04	ATEM	4.11838358E+02
ALTI	3.00000000E+04	GCRAD	2.09557410E+07	GDLAT	3.20000000E+01	DENS	8.90687151E-04	LONG	3.20000000E+01	LONGI	2.79600000E+02
VELI	1.52648841E+03	GAMMAI	0.	AZVELI	5.55638441E+01	XI	5.55638441E+01	VXI	2.96372682E+06	AXI	-2.27275832E+00
VELR	8.64000000E+02	GAMMAR	2.41250963E-13	AZVELR	3.57550000E+02	YI	-1.75322605E+07	VYI	6.60984674E+02	AYI	5.27218406E+00
VELA	8.64000000E+02	GAMMAA	2.41250963E-13	AZVELA	3.57550000E+02	ZI	1.11048509E+07	VZI	7.32043786E+02	AZI	3.27412436E+01
GAMAD	8.30441983E-01	GAZVAD	4.22302236E-03	DWNRNG	0.	CRRNG	0.	DPRNGI	5.02817697E-04	DPRNG2	5.02817697E-04
THRUST	1.26618496E+06	WEIGHT	1.18500000E+06	MDOT	2.71981646E+03	WEICON	7.45058060E-09	WPRROP	3.09300000E+05	ASMG	1.68263784E+00
ETA	1.00000000E+00	ETAL	1.00000000E+00	IPNULL	0.	IYNULL	0.	INCPCH	0.	INCYAM	0.
FIXB	1.26618496E+06	FAYB	2.16345321E+04	AXB	3.49656578E+01	BETA	3.49656578E+01	ALPDOT	0.	ALPTOT	5.45222989E+00
FTYB	0.	FAYB	0.	AYB	0.	ALPHA	5.45222989E+00	BETDOT	0.	ALPHA	1.81257855E+03
FTZB	0.	FAZB	-1.52225530E+06	AZB	-4.13308373E+01	BNKANG	5.0888749E-14	BNKDOT	0.	QALPHA	1.81257855E+03
CA	-7.23073292E-03	CD	4.11432660E-02	DRAG	1.23101671E+05	ROLI	4.8344312E-13	YAMR	5.57550000E+02	QALTOT	0.
CN	5.08770955E-01	CL	5.07156188E-01	LIFT	1.51742388E+06	YAWI	5.08888749E-14	PITR	5.45222989E+00	PITBD	0.
CY	0.	HEATRT	0.	TLHEAT	0.	PITI	-8.45477701E+01	ROLR	0.	YAMBD	0.
DYNP	3.32447198E+02	MACH	8.68476219E-01	REYNO	2.47691486E+06	ASXI	2.26065162E+00	ASYI	-2.12812884E+01	ASZI	4.97275734E+01
PWPROP	0.	PWDOT	1.22554062E+02	THRI	1.92962145E+05	THR2	9.50838484E+05	THR3	1.22384336E+05	XMAX1	3.32447198E+02
YXMX1	0.	TIMRF1	0.	XMAX2	5.45222989E+00	YXMX2	0.	VIDEAL	0.	DLI	0.
TIME	0.	TVLR	0.	ATL	0.	GLR	0.	VIDEAL	0.	DLI	0.
DIR	0.	GLI	0.	ATL	0.	GLR	0.	VIDEAL	0.	DLI	0.
TVLI	0.	GLI	0.	ATL	0.	GLR	0.	VIDEAL	0.	DLI	0.

TIME	1.89577668E+01	TIMES	1.89577668E+01	TDURP	1.89577668E+01	*** PHASE	1.000 ***	PRES	8.00967327E-04	ATEM	4.01691157E+02
ALTI	3.28539670E+04	GCRAD	2.09585950E+07	GDLAT	3.20566358E+01	DENS	8.00967327E-04	LONG	3.20566358E+01	LONGI	2.79676391E+02
VELI	1.80568267E+03	GAMMAI	9.61226725E+00	AZVELI	4.42420881E+01	XI	4.42420881E+01	VXI	2.98564655E+06	AXI	1.81613784E-01
VELR	1.31165899E+03	GAMMAR	1.32894886E+01	AZVELR	3.57612893E+02	YI	-1.75101932E+07	VYI	6.24187207E+02	AYI	-5.12859337E+01
VELA	1.31165899E+03	GAMMAA	1.32894886E+01	AZVELA	3.57612893E+02	ZI	1.11239270E+07	VZI	1.24098434E+03	AZI	2.25168002E+01
GAMAD	5.33758101E-01	GAZVAD	2.57904131E-03	DWNRNG	3.40728580E+03	CRRNG	2.18237447E-03	DPRNGI	3.40728650E+00	DPRNG2	3.40728650E+00
THRUST	1.35174517E+06	WEIGHT	1.13300000E+06	MDOT	2.75803952E+03	WEICON	5.20000000E+04	WPRROP	2.57300000E+05	ASMG	1.58559081E+00
ETA	1.00000000E+00	ETAL	1.00000000E+00	IPNULL	0.	IYNULL	0.	INCPCH	0.	INCYAM	0.
FIXB	1.35174517E+06	FAYB	-3.48561642E+05	AXB	2.84875788E+01	BETA	2.84875788E+01	ALPDOT	0.	ALPTOT	1.90688356E+00
FTYB	0.	FAYB	0.	AYB	0.	ALPHA	1.90688356E+00	BETDOT	0.	ALPHA	1.31386555E+03
FTZB	0.	FAZB	-1.49028227E+06	AZB	-4.23198244E+01	BNKANG	1.94033660E-13	BNKDOT	0.	QALPHA	1.31386555E+03
CA	5.62095876E-02	CD	6.41753457E-02	DRAG	3.97958157E+05	ROLI	-2.24112936E-02	YAMR	3.57612893E+02	QALTOT	3.97165970E-03
CH	-2.40325312E-01	CL	2.38321838E-01	LIFT	1.47785911E+06	YAWI	6.70846211E-02	PITR	1.51963721E+01	ROLBD	5.10652423E-01
CY	0.	HEATRT	0.	TLHEAT	0.	PITI	-7.48574934E+01	ROLR	0.	YAMBD	-1.12481256E-03
DYNP	6.89011839E+02	MACH	1.33500345E+00	REYNO	3.45208314E+06	ASXI	4.74668742E+00	ASYI	-3.19017964E+01	ASZI	3.95253593E+01
PWPROP	2.76170520E+03	PWDOT	1.60777125E+02	THRI	2.63139585E+05	THR2	9.64302271E+05	THR3	1.24303312E+05	XMAX1	6.89011839E+02
YXMX1	1.89577668E+01	TIMRF1	0.	XMAX2	5.45222989E+00	YXMX2	0.	VIDEAL	0.	DLI	1.01872462E+02
TIME	1.89577668E+01	TVLR	0.	ATL	0.	GLR	0.	VIDEAL	0.	DLI	0.
DIR	1.64012409E+02	GLI	0.	ATL	0.	GLR	0.	VIDEAL	0.	DLI	0.
TVLI	2.57098115E+02	GLI	0.	ATL	0.	GLR	0.	VIDEAL	0.	DLI	0.

END OF PHASE 1.000

MODEL 896-111 LOWER STAGE

BEGIN PHASE 6.000

1962 U.S. STANDARD ATMOSPHERE MODEL

COMPUTE DOWN AND CROSS RANGE BASED ON RELATIVE GREAT CIRCLES

LATREF = 3.20000000E+01 LONREF = 2.79600000E+02 AZREF = -2.45000000E+00

AERODYNAMIC COEFFICIENTS SPECIFIED BY DRAG AND LIFT COEFFICIENTS

SREF = 9.00000000E+03 LREF = 1.00000000E+00 LREFY = 0.

PROPULSION CALCULATED FOR 3 ROCKET ENGINES

VEHICLE WEIGHT PARAMETERS

WGTSO = 3.47500000E+05 WPLD = 5.77500000E+05 WPROP = 4.93000000E+04 WJETT = 0.  
GO = 3.21740000E+01

NUMBER OF INTEGRALS FOR THIS PHASE = 17

INTEGRATION SCHEME = FOURTH ORDER RUNGE-KUTTA

DT = 1.00000000E+00 PINC = 3.00000000E+01

USE RELATIVE YAW, PITCH, AND ROLL COMMANDS

ROLPC = 0.  
PIIPC = 2.94730293E+01, 0.  
YAMPC = 3.63797881E-12, 0.  
YAMI = 3.41183821E-01 YAMR = 3.57777713E+02 DYAM = 0.  
PIII = -6.09952232E+01 PIIR = 2.94730293E+01 DPITCH = 0.  
ROLI = -2.60602318E-02 ROLR = 0.  
DESN = 0.  
DESN = 0.  
DESN = 0.

THE NEXT EVENT TO OCCUR WILL BE ONE OF THE FOLLOWING

ESN = 7.000 TYPE = PRIMRY CRITR = WEICON VALUE = 3.09300000E+05  
TOL = 1.00000000E-06 MDL = 1

TABLES AND MULTIPLIERS FOR THIS PHASE

CDT = 1.00000000E+00 CLT = 1.00000000E+00 TVC1T = 8.00000000E+00 TVC2T = 2.00000000E+00 TVC3T = 4.00000000E+00  
WD1T = 8.00000000E+00 WD2T = 2.00000000E+00 WD3T = 4.00000000E+00 AE1T = 1.00000000E+00 AE2T = 2.00000000E+00  
AEST = 4.00000000E+00

PROGRAM CONTROL FLAGS

NPC ( 1 ) = 0 NPC ( 2 ) = 1 NPC ( 3 ) = 4 NPC ( 4 ) = 2 NPC ( 5 ) = 2 NPC ( 6 ) = 0 NPC ( 7 ) = 0  
NPC ( 8 ) = 2 NPC ( 9 ) = 1 NPC ( 10 ) = 0 NPC ( 11 ) = 0 NPC ( 12 ) = 1 NPC ( 13 ) = 0 NPC ( 14 ) = 0  
NPC ( 15 ) = 0 NPC ( 16 ) = 1 NPC ( 17 ) = 0 NPC ( 18 ) = 0 NPC ( 19 ) = 1 NPC ( 20 ) = 0 NPC ( 21 ) = 0  
NPC ( 22 ) = 0 NPC ( 23 ) = 0 NPC ( 24 ) = 0 NPC ( 25 ) = 3 NPC ( 26 ) = 0 NPC ( 27 ) = 1 NPC ( 28 ) = 0  
NPC ( 29 ) = 0 NPC ( 30 ) = 0 NPC ( 31 ) = 0 NPC ( 32 ) = 0 NPC ( 33 ) = 0 NPC ( 34 ) = 0 NPC ( 35 ) = 0

GUIDANCE CONTROL FLAGS

IGUID ( 1 ) = 2 IGUID ( 2 ) = 0 IGUID ( 3 ) = 0 IGUID ( 4 ) = 0 IGUID ( 5 ) = 1 IGUID ( 6 ) = 0 IGUID ( 7 ) = 0  
IGUID ( 8 ) = 0 IGUID ( 9 ) = 0 IGUID ( 10 ) = 0 IGUID ( 11 ) = 0 IGUID ( 12 ) = 2 IGUID ( 13 ) = 0 IGUID ( 14 ) = 0  
IGUID ( 15 ) = 0 IGUID ( 16 ) = 0 IGUID ( 17 ) = 0 IGUID ( 18 ) = 0 IGUID ( 19 ) = 0 IGUID ( 20 ) = 0 IGUID ( 21 ) = 0  
IGUID ( 22 ) = 0 IGUID ( 23 ) = 0 IGUID ( 24 ) = 0 IGUID ( 25 ) = 0



BOEING PROPRIETARY

MODEL 896-111 LOWER STAGE

TIME	9.65726848E+01	TIMES	0.	TDURP	0.	*** PHASE	6.000 ***	PRES	7.93773546E-05	ATEM	3.98562663E+02
ALTI	8.15954770E+04	GCRAD	2.11328658E+01	ADZVELI	3.24816981E+01	DENS	3.24816981E+01	LONG	3.24816981E+01	LONGI	2.79980604E+02
VELI	3.07646684E+03	GAMMAI	2.11328658E+01	ADZVELI	3.24816981E+01	GCLAT	3.07131364E+06	VXI	1.09206491E+03	AXI	-1.40756964E+00
VELR	2.83841762E+03	GAMMAR	2.30023319E+01	ADZVELR	3.57777713E+02	YI	-1.74528311E+07	VYI	6.65756719E+02	AYI	3.61073675E+00
VELA	2.83841762E+03	GAMMAA	2.30023319E+01	ADZVELA	3.57777713E+02	ZI	1.12815736E+07	VZI	2.79800135E+03	AZI	2.08120022E+01
GAMAD	2.14106848E-03	AZVAD	1.27837402E-03	DMMNRG	3.89777158E+01	CKRNG	7.84758366E-02	DPRNG1	2.89772645E+01	DPRNG2	2.89772645E+01
THRUST	1.18760391E+06	WEIGHT	9.25000000E+05	WDOT	2.60526240E+03	WEICON	2.60000000E+05	WPROP	4.93000000E+04	ASMG	1.38095796E+00
ETA	1.00000000E+00	ETAL	1.00000000E+00	IPNULL	0.	IYNUL	0.	INCPCH	0.	INCYAM	0.
FTXB	1.18760391E+06	FAYB	-1.32783048E+05	AXB	3.66895205E+01	ALPHA	6.47069740E+00	ALPDOT	0.	ALPTOT	6.47069740E+00
FTYB	0.	FAYB	0.	AYB	0.	BETA	-2.23978505E-12	BEIDOT	0.	QALPHA	2.06904675E+03
FTZB	0.	FAYB	-7.20463892E+05	ABZ	-2.50596814E+01	BNKANG	-9.50839932E-13	BNKDOT	0.	QALTOT	2.06904675E+03
CA	4.61403528E-02	CD	7.40598179E-02	DRAG	-2.13129891E+05	ROLI	-2.60602318E-02	YAWR	3.57777713E+02	ROLBD	0.
CN	2.50351672E-01	CL	2.43557047E-01	LIFT	7.00910271E+05	YANI	3.61183821E-01	PITR	2.94730293E+01	PIIBD	0.
CY	0.	CL	0.	TLHEAT	0.	PITI	-6.09952232E+01	ROLR	0.	YAMBD	0.
DYNP	3.19756377E+02	MACH	2.90025092E+00	REYNO	7.45148901E+05	ASXI	3.25587774E+00	ASYI	-2.28894418E+01	ASZI	3.79418142E+01
PMPROP	9.17539681E+03	PWDDT	8.00000000E+00	THRI	0.	THR2	1.05095071E+06	THR3	1.36653204E+05	XMAX1	8.982695553E+02
YXMX1	5.50000000E+01	TIMRF1	0.	XMAX2	6.47069740E+00	YMX2	9.65726848E+01				

TIME	9.65726848E+01	TVLR	6.08776444E+00	ATL	6.08776444E+00	*** VELOCITY LOSSES ***	7.92566488E+02	VIDEAL	3.97716852E+03	DLI	7.91707990E+02
DLR	1.01187846E+03	TVLI	6.69740226E+02		6.69740226E+02	TABLE LIMIT =	3.00000000E+00				
TVLI	7.76215732E+02	GLI	3.00836339E+00		3.00836339E+00	TABLE LIMIT =	3.00000000E+00				
++WARNING++ GENTAB(CDI ) ;											
++WARNING++ GENTAB(CLT ) ;											

TIME	1.15495923E+02	TIMES	1.89232378E+01	TDURP	1.89232378E+01	*** PHASE	6.000 ***	PRES	2.77674056E-05	ATEM	4.10647613E+02
ALTI	1.03818182E+05	GCRAD	2.10295592E+07	GDLAT	3.26269100E+01	DENS	3.26269100E+01	LONG	3.26269100E+01	LONGI	2.80053020E+02
VELI	3.48180156E+03	GAMMAI	2.06470178E+01	ADZVELI	2.11375415E+01	GCLAT	3.09163563E+06	VXI	1.05135808E+03	AXI	-2.80669342E+00
VELR	3.27964869E+03	GAMMAR	2.19837759E+01	ADZVELR	3.57802909E+02	YI	-1.74391547E+07	VYI	8.00329317E+02	AYI	1.01737664E+01
VELA	3.27964869E+03	GAMMAA	2.19837759E+01	ADZVELA	3.57802909E+02	ZI	1.13384317E+07	VZI	3.22134464E+03	AZI	2.38407658E+01
GAMAD	-9.59761298E-02	AZVAD	1.42637436E-03	DMMNRG	3.77119664E+01	CKRNG	1.17256276E-01	DPRNG1	3.77121487E+01	DPRNG2	3.77121487E+01
THRUST	1.19450885E+06	WEIGHT	8.75700000E+05	WDOT	2.60526240E+03	WEICON	3.09300000E+05	WPROP	0.	ASMG	1.37174267E+00
ETA	1.00000000E+00	ETAL	1.00000000E+00	IPNULL	0.	IYNUL	0.	INCPCH	0.	INCYAM	0.
FTXB	1.19450885E+06	FAYB	-7.72767193E+04	AXB	4.10481261E+01	ALPHA	1.07481453E+01	ALPDOT	0.	ALPTOT	1.07481453E+01
FTYB	0.	FAYB	0.	AYB	0.	BETA	-8.10336977E-13	BEIDOT	0.	QALPHA	1.60506819E+03
FTZB	0.	FAYB	-4.41332596E+05	ABZ	-1.62142189E+01	BNKANG	-2.72251363E-13	BNKDOT	0.	QALTOT	1.60506819E+03
CA	5.74967336E-02	CD	1.17723724E-01	DRAG	1.58221851E+05	ROLI	-1.29167474E-02	YAWR	3.57802909E+02	ROLBD	4.06616248E-03
CN	3.28355167E-01	CL	3.11871952E-01	LIFT	4.19158992E+05	YANI	4.07901657E-01	PITR	3.27319212E+01	PIIBD	1.64099913E-01
CY	0.	CL	0.	TLHEAT	0.	PITI	-5.78789960E+01	ROLR	0.	YAMBD	1.76886617E-04
DYNP	1.49534434E+02	MACH	3.30141605E+00	REYNO	2.93814485E+05	ASXI	1.87274443E+00	ASYI	-1.62217893E+01	ASZI	4.10023893E+01
PMPROP	9.32678271E+03	PWDDT	8.00000000E+00	THRI	0.	THR2	1.05699427E+06	THR3	1.37514585E+05	XMAX1	8.982695553E+02
YXMX1	5.50000000E+01	TIMRF1	0.	XMAX2	1.07481453E+01	YMX2	1.15495923E+02				

TIME	1.15495923E+02	TVLR	1.50923198E+01	ATL	1.50923198E+01	*** VELOCITY LOSSES ***	1.024669310E+03	VIDEAL	4.78775524E+03	DLI	9.02731848E+02
DLR	1.13521438E+03	TVLI	8.86201555E+02		8.86201555E+02	TABLE LIMIT =	3.00000000E+00				
TVLI	8.49400125E+02	GLI	3.00836339E+00		3.00836339E+00	TABLE LIMIT =	3.00000000E+00				

END OF PHASE 6.000

MODEL 896-111 UPPER STAGE

BEGIN PHASE 7.000

1962 U.S. STANDARD ATMOSPHERE MODEL

COMPUTE DOWN AND CROSS RANGE BASED ON RELATIVE GREAT CIRCLES

LATREF = 3.2000000E+01 LONREF = 2.7960000E+02 AZREF = -2.450000000E+00

AERODYNAMIC COEFFICIENTS SPECIFIED BY DRAG AND LIFT COEFFICIENTS

SREF = 2.5100000E+03 LREF = 1.0000000E+00 LREFY = 0.

PROPULSION CALCULATED FOR 2 ROCKET ENGINES

VEHICLE HEIGHT PARAMETERS

WGTS0 = 5.49908000E+05 WPLD = 2.7592000E+04 NPROP = 4.59114000E+05 WJETT = 0.  
G0 = 3.2174000E+01

NUMBER OF INTEGRALS FOR THIS PHASE = 17  
INTEGRATION SCHEME = FOURTH ORDER RUNGE-KUTTA

DT = 1.0000000E+00 PINC = 3.000000000E+01

USE RELATIVE YAW, PITCH, AND ROLL COMMANDS

ROLPC = 0.05093425E+01, 0.17062469E-01, 0.  
PITPC = 3.63797881E-12, 0.  
YAWPC = 4.07901657E-01 YAWR = 3.57802909E+02 DYAM = 0.  
PITI = -5.78789960E+01 PITR = 3.27319212E+01 DPIACH = 0.  
ROLI = -1.29167474E-02 ROLR = 0.  
DESN = 0.  
DESN = 0.  
DESN = 0.

THE NEXT EVENT TO OCCUR WILL BE ONE OF THE FOLLOWING

ESN = 8.000 TYPE = PRIMRY CRITR = TIMRF1 VALUE = 1.000000000E+01  
TOL = 1.00000000E-06 MDL = 1

TABLES AND MULTIPLIERS FOR THIS PHASE

CDT = 1.00000000E+00 CLT = 1.00000000E+00 TVCIT = 4.00000000E+00 TVC2T = 1.00000000E+00 TVC3T = 4.00000000E+00  
WD1T = 8.00000000E+00 WD2T = 2.00000000E+00 WD3T = 4.00000000E+00 AE1T = 4.00000000E+00 AE2T = 1.00000000E+00  
AE3T = 4.00000000E+00

PROGRAM CONTROL FLAGS

NPC (1) = 0 NPC (2) = 1 NPC (3) = 4 NPC (4) = 2 NPC (5) = 2 NPC (6) = 0 NPC (7) = 0  
NPC (8) = 2 NPC (9) = 1 NPC (10) = 0 NPC (11) = 0 NPC (12) = 1 NPC (13) = 0 NPC (14) = 0  
NPC (15) = 0 NPC (16) = 1 NPC (17) = 0 NPC (18) = 0 NPC (19) = 1 NPC (20) = 0 NPC (21) = 1  
NPC (22) = 0 NPC (23) = 0 NPC (24) = 0 NPC (25) = 3 NPC (26) = 0 NPC (27) = 0 NPC (28) = 0  
NPC (29) = 0 NPC (30) = 0 NPC (31) = 0 NPC (32) = 0 NPC (33) = 0 NPC (34) = 0 NPC (35) = 0

GUIDANCE CONTROL FLAGS

IGUID (1) = 2 IGUID (2) = 0 IGUID (3) = 0 IGUID (4) = 1 IGUID (5) = 1 IGUID (6) = 0 IGUID (7) = 0  
IGUID (8) = 0 IGUID (9) = 0 IGUID (10) = 0 IGUID (11) = 0 IGUID (12) = 2 IGUID (13) = 0 IGUID (14) = 0  
IGUID (15) = 0 IGUID (16) = 0 IGUID (17) = 0 IGUID (18) = 0 IGUID (19) = 0 IGUID (20) = 0 IGUID (21) = 0  
IGUID (22) = 0 IGUID (23) = 0 IGUID (24) = 0 IGUID (25) = 0

BOEING PROPRIETARY

PAGE 21  
PROBLEM NO. 1

MODEL 896-111 UPPER STAGE

TIME	1.15495923E+02	TIMES	0.	TDURP	0.	*** PHASE	7.000 ***	PRES	1.95731810E+01	ATEM	4.10647613E+02
ALTTITO	1.03818182E+05	GCRAD	2.10295592E+07	GDLAT	3.26269100E+01	DENS	2.77674005E-05	LONG	2.79570470E+02	LONGI	2.80053020E+02
VELI	3.48180156E+03	GAMMAI	2.06470178E+01	AZVELI	2.11375415E+01	GCLAT	3.09163563E+06	VXI	1.05135808E+03	AXI	-2.81703591E+00
VELR	3.27964869E+03	GAMMAR	2.19837759E+01	AZVELR	3.57802909E+02	YI	-1.74391547E+07	VYI	8.00329317E+02	AYI	1.14852444E+01
VELA	3.27964869E+03	GAMMAA	2.19837759E+01	AZVELA	3.57802909E+02	ZI	1.13384347E+07	VZI	3.22134466E+03	AZI	1.62428979E+01
GAMAD	-1.40666659E-01	AZVAD	1.42637436E-03	DMNRNG	3.77119664E+01	CRRNG	1.17256276E-01	DPRNG1	3.77121487E+01	DPRNG2	3.77121487E+01
THRUST	6.6011718E+05	WEIGHT	5.77500000E+05	WDOT	1.45876110E+03	WEICON	3.09300000E+05	WPROP	4.59114000E+05	ASMG	1.13845070E+00
ETA	1.00000000E+00	ETAL	1.00000000E+00	IPNULL	0.	IYNULL	0.	INCPCH	0.	INCYAM	0.
FTXB	6.66011718E+05	FAYB	-3.49490450E+04	AXB	3.51581133E+01	ALPHA	1.85255666E+01	ALPDDT	0.	ALPTOT	1.85255666E+01
FTYB	0.	FAYZ	0.	AYB	0.	BETA	-8.10336977E-13	BEIDOT	0.	QALPHA	2.76650500E+03
FTZB	0.	FAZB	-1.84410819E+05	AZB	-1.02739977E+01	BHKANG	-2.72251363E-13	BNKDDT	0.	QALTTOT	2.76650500E+03
CA	9.32398641E-02	CD	2.44725971E-01	DRAG	9.17306958E+04	ROLI	-1.29167474E-02	YAMR	3.57802909E+02	ROLBD	0.
CN	4.91985967E-01	CL	4.36867329E-01	LIFT	1.63750731E+05	YAMI	4.07901657E-01	PITR	4.05093425E+01	PITBD	0.
CY	0.	HEATRT	0.	TLHEAT	0.	PITI	-5.01015747E-01	ROLR	0.	YAMBD	0.
DYNP	1.49334434E+02	MACH	3.30141605E+00	REYNO	2.93814485E+05	ASXI	1.86240195E+00	ASYI	-1.49103109E+01	ASZI	3.34045214E+01
PWPROP	9.32678271E+03	PWDDT	0.	THRI	1.37514585E+05	THR2	5.28497133E+05	THR3	1.37514585E+05	XMAX1	8.98269553E+02
YXMX1	5.50000000E+01	TIMRF1	0.	XMAX2	1.85255666E+01	YXMX2	1.15495923E+02				
TIME	1.15495923E+02	TIME	1.50923198E+01	ATL	1.94109044E+02	GLR	1.02469310E+03	VIDEAL	4.78775524E+03	DLI	9.02731848E+02
DLR	1.13521438E+03	TVLR	8.86201555E+02								
TVLI	8.49400125E+02	GLI									

TIME	1.20000000E+02	TIMES	4.50407734E+00	TDURP	4.50407734E+00	DENS	2.13256515E-05	PRES	1.52788587E+01	ATEM	4.17380163E+02
ALTTITO	1.09330737E+05	GCRAD	2.10350784E+07	GDLAT	3.26647654E+01	GCLAT	3.09634092E+06	LONG	2.79568747E+02	LONGI	2.80070116E+02
VELI	3.56112342E+03	GAMMAI	2.00726741E+01	AZVELI	2.05009361E+01	XI	-1.74354264E+07	VXI	1.03765903E+03	AXI	-3.25374609E+00
VELR	3.36517720E+03	GAMMAR	2.12973097E+01	AZVELR	3.57809350E+02	YI	-1.74354264E+07	VYI	8.56677177E+02	AYI	1.34779519E+01
VELA	3.36517720E+03	GAMMAA	2.12973097E+01	AZVELA	3.57809350E+02	ZI	1.13531098E+07	VZI	3.29723482E+03	AZI	1.74305557E+01
GAMAD	-1.62768827E-01	AZVAD	1.52495551E-03	DMNRNG	3.99890193E+01	CRRNG	1.28084018E-01	DPRNG1	3.99892245E+01	DPRNG2	3.99892245E+01
THRUST	6.66491824E+05	WEIGHT	5.70929627E+05	WDOT	1.45876110E+03	WEICON	3.15870373E+05	WPROP	4.52543627E+05	ASMG	1.14850306E+00
ETA	1.00000000E+00	ETAL	1.00000000E+00	IPNULL	0.	IYNULL	0.	INCPCH	0.	INCYAM	0.
FTXB	6.66491824E+05	FAYB	-2.80262246E+04	AXB	3.59799023E+01	ALPHA	1.86847744E+01	ALPDDT	0.	ALPTOT	1.86847744E+01
FTYB	0.	FAYZ	0.	AYB	0.	BETA	-2.51633370E-12	BEIDOT	0.	QALPHA	2.25619196E+03
FTZB	0.	FAZB	-1.49409125E+05	AZB	-8.41975782E+00	BHKANG	-9.80941398E-13	BNKDDT	0.	QALTTOT	2.25619196E+03
CA	9.24703900E-02	CD	2.45523356E-01	DRAG	7.44140121E+04	ROLI	-1.05100884E-02	YAMR	3.57809550E+02	ROLBD	4.00799950E-03
CN	4.92964010E-01	CL	4.37358629E-01	LIFT	1.32556066E+05	YAMI	4.23762883E-01	PITR	3.99820841E+01	PITBD	-1.25609047E-01
CY	0.	HEATRT	0.	TLHEAT	0.	PITI	-5.06660922E+01	ROLR	0.	YAMBD	6.90227270E-04
DYNP	1.20750291E+02	MACH	3.36008003E+00	REYNO	2.28454134E+05	ASXI	1.42912557E+00	ASYI	-1.28911936E+01	ASZI	3.46008730E+01
PWPROP	9.32678271E+03	PWDDT	0.	THRI	1.37621054E+05	THR2	5.28870739E+05	THR3	1.37514585E+05	XMAX1	8.98269553E+02
YXMX1	5.50000000E+01	TIMRF1	4.50407734E+00	XMAX2	1.86847744E+01	YXMX2	1.20000000E+02				
TIME	1.20000000E+02	TIME	1.50923198E+01	ATL	1.94597864E+02	GLR	1.07756861E+03	VIDEAL	4.95639024E+03	DLI	9.21965619E+02
DLR	1.15609597E+03	TVLR	2.38721090E+01								
TVLI	8.68995414E+02	GLI	9.36085953E+02								

BOEING PROPRIETARY

MODEL 896-111 UPPER STAGE

BEGIN PHASE 17.000

1962 U.S. STANDARD ATMOSPHERE MODEL

COMPUTE DOWN AND CROSS RANGE BASED ON RELATIVE GREAT CIRCLES

LATREF = 3.2000000E+01 LONREF = 2.79600000E+02 AZREF = -2.45000000E+00

COMPUTE CONIC PARAMETERS

AERODYNAMIC COEFFICIENTS SPECIFIED BY DRAG AND LIFT COEFFICIENTS  
 SREF = 2.5100000E+03 LREF = 1.0000000E+00 LREFY = 0.

PROPULSION CALCULATED FOR 2 ROCKET ENGINES

CALCULATE ETAL TO LIMIT ACCELERATION  
 ASMAX = 3.15000000E+00

ENGINES USED TO THROTTLE

1 2

VEHICLE WEIGHT PARAMETERS  
 WGTSG = 1.23288337E+05 WPLD = 2.75920000E+04 WPROP = 3.24943369E+04 WJETT = 0.  
 GO = 3.21740000E+01

NUMBER OF INTEGRALS FOR THIS PHASE = 17  
 INTEGRATION SCHEME = FOURTH ORDER RUNGE-KUTTA  
 DT = 1.00000000E+00 PINC = 3.00000000E+01

USE RELATIVE YAW, PITCH, AND ROLL COMMANDS

ROLPC = 0.0000000E+00, 0.03371544E-01, 0.0000000E+00, 0.0000000E+00, 0.0000000E+00  
 PITPC = 3.30079724E+00, -1.03371544E-01, 0.0000000E+00, 0.0000000E+00, 0.0000000E+00  
 YAMPC = 1.27329258E-11, 0.0000000E+00, 0.0000000E+00, 0.0000000E+00, 0.0000000E+00  
 YAWR = 1.38761999E+00 YAWR = 3.58857038E+02 DYAW = 0.0000000E+00, DESN = 0.  
 PITR = -9.52952334E+01 PITR = 3.30079724E+00 DPITCH = 0.0000000E+00, DESN = 0.  
 ROLI = -5.59442976E-01 ROLI = 0.0000000E+00 DROLL = 0.0000000E+00, DESN = 0.

THE NEXT EVENT TO OCCUR WILL BE ONE OF THE FOLLOWING

ESN = 18.000 TYPE = PRIMRY CRITR = VELI VALUE = 2.58000000E+04  
 TOL = 1.00000000E-06 MDL

TABLES AND MULTIPLIERS FOR THIS PHASE

CDT = 1.00000000E+00 CLT = 1.00000000E+00 TVC1T, 4.00000000E+00 TVC2T, 1.00000000E+00 TVC3T, 4.00000000E+00  
 WDT, 8.00000000E+00 WD2T, 2.00000000E+00 WD3T, 4.00000000E+00 AE1T, 4.00000000E+00 AE2T, 1.00000000E+00  
 AE3T, 4.00000000E+00

PROGRAM CONTROL FLAGS

NPC (1) = 2 NPC (2) = 1 NPC (3) = 4 NPC (4) = 2 NPC (5) = 2 NPC (6) = 0 NPC (7) = 1  
 NPC (8) = 2 NPC (9) = 1 NPC (10) = 0 NPC (11) = 0 NPC (12) = 1 NPC (13) = 0 NPC (14) = 0  
 NPC (15) = 0 NPC (16) = 1 NPC (17) = 0 NPC (18) = 0 NPC (19) = 1 NPC (20) = 0 NPC (21) = 1  
 NPC (22) = 0 NPC (23) = 0 NPC (24) = 0 NPC (25) = 3 NPC (26) = 0 NPC (27) = 0 NPC (28) = 0  
 NPC (29) = 0 NPC (30) = 0 NPC (31) = 0 NPC (32) = 0 NPC (33) = 0 NPC (34) = 0 NPC (35) = 0

BOEING PROPRIETARY

PAGE 56  
PROBLEM NO. 1

MODEL 896-111 UPPER STAGE

GUIDANCE CONTROL FLAGS

IGUID ( 1 ) = 2 IGUID ( 2 ) = 0 IGUID ( 3 ) = 0 IGUID ( 4 ) = 0 IGUID ( 5 ) = 1 IGUID ( 6 ) = 0 IGUID ( 7 ) = 0  
IGUID ( 8 ) = 0 IGUID ( 9 ) = 0 IGUID ( 10 ) = 0 IGUID ( 11 ) = 0 IGUID ( 12 ) = 2 IGUID ( 13 ) = 2 IGUID ( 14 ) = 0  
IGUID ( 15 ) = 0 IGUID ( 16 ) = 0 IGUID ( 17 ) = 0 IGUID ( 18 ) = 0 IGUID ( 19 ) = 0 IGUID ( 20 ) = 0 IGUID ( 21 ) = 0  
IGUID ( 22 ) = 0 IGUID ( 23 ) = 0 IGUID ( 24 ) = 0 IGUID ( 25 ) = 0





# Appendix C

o POST OPTIMIZED PERFORMANCE TRAJECTORY FOR CONCEPT B-2



POST OPTIMIZED PERFORMANCE TRAJECTORY FOR CONCEPT B-2

POST (Program to Optimize Simulated Trajectories) was used to optimize ascent to polar orbit. The input and output files for this case are included on the following pages.

BOEING PROPRIETARY

P O S T - MHC 3D TARGETING AND OPTIMIZATION PROGRAM. REVISED 030177 , PROBLEM NO. 1

```

P$SEARCH
C*****
C POST OPTIMIZATION OF *****
C SORTIE VEHICLE FOR *****
C BATTLE CONTRACT WITH *****
C ONCE-AROUND ORBIT DEFINED *****
C AS A 56X100 H. MI. *****
C
C INERTIAL VEL = 25814 FPS *****
C ALTITUDE = 340495 FT *****
C GAMMA = 0.0 DEGREES *****
C*****
C SRCMI=4., MAXITR=0, IPRO=-1, *****
C HINDV=8, *****
C INDIR=6HPITPC1, 6*6HPITPC2,6HGMAMAR, *****
C IDPH=1,1,2,3,4,5,6,1, *****
C U=3.99597656E+01,-1.66386047E-2,-1.01857470E-2,-2.76230065E-1,-7.12540844E-2, *****
C -1.81466192E-01,-5.76474754E-2,1.97058553E+01, *****
C PERT=9.26336784E-5,4.71515320E-6,3.12248301E-6,1.87906582E-6,2.20836545E-6, *****
C 2.07076756E-6,4.89715650E-5,1.86047431E-3, *****
C HDEPV=3, *****
C DEFVR= 6HALTITO, 6HGAMMAI, 4HVELI, *****
C DEPH= 7, *****
C DEPV= 340495., 0.0, 25814., *****
C DEPI= 100., .001, 1., *****
C OPT=1, *****
C OP1VAR=6HMEIGHT, *****
C OP1PH=7, *****
C HOP1=2.E-5,CONEP'S=89.8, *****
$
P$GENDAT EVENT=1., *****
TITLE=0H*ALTERNATE CONFIGURATION USING SSHE & OMS KIT *, *****
NPC(2)=1, 4, 2, NPC(7)=1, 2, 1, NPC(15)=1, 1, *****
NPC(25)=3, *****
NPC(21)=1, *****
IGUID(1)=2, IGUID(4)=1, *****
HENG=2, IENGA(1)=1, *****
ASMAX=5., YSPV=465.7,430.9, *****
MAXTH=1000., ALTIMAX=2.E6, FESH=7., *****
PTHC=10., *****
GDLAT=32., LONG=262.5, AZI=0., *****
NPC(12)=1, LATREF=32., LONGREF=262.5, AZREF=0., *****
INSTG=420000., HPROPI=359649., HPLD=5000., *****
SREF=940.00, *****
VELR=800., ALTIIO=25000., *****
AZVELR=0.0, *****
$
P$LIMIT
TVCIN=1., TVC2M=2., *****
AEN=1., AEN2=2., *****
$
P$TAB TABLE=3HCLT, 2, 5HALPHA, 4HMACI, 8,8,8*1, /ALSV CL TABLE *****
-18.,-0.17,-9.,0.0,-5.,0.06,-1.,0.15,3.,0.26,7.,0.38,11.,0.53,21.,0.91, *****

```

BOEING PROPRIETARY

```

-18.,-0.17,-9.,0.0,-5.,0.06,-1.,0.15,3.,0.26,7.,0.38,11.,0.53,21.,0.91,
-9.,
-18.,-0.20,-9.,0.0,-5.,0.07,-1.,0.18,3.,0.28,7.,0.42,11.,0.90,21.,1.00,
1.2,
-18.,-0.31,-9.,0.0,-5.,0.11,-1.,0.27,3.,0.45,7.,0.66,11.,0.90,21.,1.50,
2.0,
-18.,-0.25,-9.,0.0,-5.,0.10,-1.,0.22,3.,0.37,7.,0.56,11.,0.80,21.,1.45,
5.0,
-18.,-0.17,-9.,0.0,-5.,0.06,-1.,0.15,3.,0.26,7.,0.38,11.,0.53,21.,0.91,
10.,
-18.,-0.15,-9.,0.0,-5.,0.05,-1.,0.12,3.,0.21,7.,0.30,11.,0.40,21.,0.72,
30.,
-18.,-0.15,-9.,0.0,-5.,0.05,-1.,0.12,3.,0.21,7.,0.30,11.,0.40,21.,0.72,
$
P$TAB TABLE=3HCDDT,2, 5HALPHA, 4HMACH, 8,8,8*1, /ALSV CD TABLE
0.2,
-18.,-0.674,-9.,-0.35,-5.,-0.0416,-1.,-0.061,3.,-0.0975,7.,-0.154,11.,-0.24,21.,-0.985,
0.6,
-18.,-0.674,-9.,-0.35,-5.,-0.0416,-1.,-0.061,3.,-0.0975,7.,-0.154,11.,-0.24,21.,-0.5779,
9.,
-18.,-1.011,-9.,-0.60,-5.,-0.0691,-1.,-0.094,3.,-0.132,7.,-0.197,11.,-0.2416,21.,-0.6674,
1.2,
-18.,-2.283,-9.,-1.55,-5.,-0.1735,-1.,-0.215,3.,-0.283,7.,-0.387,11.,-0.5356,21.,-1.0985,
2.0,
-18.,-2.015,-9.,-1.40,-5.,-0.1508,-1.,-0.190,3.,-0.248,7.,-0.339,11.,-0.4791,21.,-1.047,
5.0,
-18.,-1.137,-9.,-0.75,-5.,-0.0844,-1.,-0.106,3.,-0.146,7.,-0.205,11.,-0.2935,21.,-0.6379,
10.,
-18.,-1.100,-9.,-0.660,-5.,-0.0741,-1.,-0.092,3.,-0.124,7.,-0.170,11.,-0.2342,21.,-0.5147,
30.,
-18.,-1.100,-9.,-0.660,-5.,-0.0741,-1.,-0.092,3.,-0.124,7.,-0.170,11.,-0.2342,21.,-0.5147,
$
P$TAB TABLE=6HTVC1T ,0, 516000.,
$
P$TAB TABLE=6HTVC2T ,0, 34500.,
$
P$TAB TABLE=6HAE1T ,0,86.95,
$
P$TAB TABLE=6HAE2T ,0,6.20,
ENDPHS=1,
$
P$GENDAT EVENT=2., CRITR=4HTIME, VALUE=20.,
TGDJ(4)=0,
ENDPHS=1,
$
P$GENDAT EVENT=3., CRITR=4HTIME, VALUE=50.,
ENDPHS=1,
$
P$GENDAT EVENT=4., CRITR=4HTIME, VALUE=100.,
ENDPHS=1,
$
P$GENDAT EVENT=5., CRITR=4HTIME, VALUE=150.,
ENDPHS=1,
$
P$GENDAT EVENT=6., CRITR=6HMEIC00, VALUE=344450.,
MULTT=21200., HPC(1)=2,
$
P$TRIMT
TVC1R=0., TVC2H=2.,

```

```

AE1H=0., AE2H=2.,
ENDPHS=1,
$
P$GENDAT EVENT=7., CRITR=4HVELI, VALUE=25814.,
ENDPHS=1,
ENDPRB=1,
ENDJOB=1,
$

```

BOEING PROPRIETARY

ALTERNATE CONFIGURATION USING SSME & OMS KIT

BEGIN PHASE 1.000

1962 U.S. STANDARD ATMOSPHERE MODEL

HEAT RATE CALCULATED USING CHIAPMAN'S EQUATION

HEATK1 = 1.00000000E+00 HEATK2 = 1.76000000E+04 HEATK3 = 2.60000000E+04 RN = 1.00000000E+00

KHOSL = 2.37690000E-03

COMPUTE DOWN AND CROSS RANGE BASED ON RELATIVE GREAT CIRCLES

LATREF = 3.20000000E+01 LOHREF = 2.62500000E+02 AZREF = 0.

AERODYNAMIC COEFFICIENTS SPECIFIED BY DRAG AND LIFT COEFFICIENTS

SREF = 9.40000000E+02 LREF = 1.00000000E+00 LREFY = 0.

PROPULSION CALCULATED FOR 2 ROCKET ENGINES

CALCULATE ETAL TO LIMIT ACCELERATION

ASHAX = 5.00000000E+00

ENGINES USED TO THROTTLE

1 2

VEHICLE HEIGHT PARAMETERS

HG1SG = 4.20000000E+05 HPLD = 5.00000000E+03 HPROP = 3.59649000E+05 HJETT = 0.

GO = 3.21740000E+01

NUMBER OF INTEGRALS FOR THIS PHASE = 18

INTEGRATION SCHEME = FOURTH ORDER RUNGE-KUTTA

DT = 1.00000000E+00 PINC = 1.00000000E+01

USE RELATIVE YAW, PITCH, AND ROLL COMMANDS

ROI PC = 0. 0. 0. 0.

PIT PC = 3.99597656E+01, -1.66386047E-02, 0.

YAW PC = 0. 0. 0.

YAWI = 0. YAWR = 0. DESH = 0.

PITR = 0. DPTCH = 0. DESH = 0.

ROLI = 0. ROLR = 0. DROLL = 0.

THE NEXT EVENT TO OCCUR WILL BE ONE OF THE FOLLOWING

ESH = 2.000 CRITR = TIME VALUE = 2.00000000E+01

TOL = 1.00000000E-06 MDL. = 1

TABLES AND MULTIPLIERS FOR THIS PHASE

CDT , 1.00000000E+00 CLT , 1.00000000E+00 TVCIT , 1.00000000E+00 TVC2T , 2.00000000E+00 AETT , 1.00000000E+00

PROGRAM CONTROL FLAGS

HPC ( 1 ) = 0 HPC ( 2 ) = 1 HPC ( 3 ) = 4 HPC ( 4 ) = 2 HPC ( 5 ) = 2 HPC ( 6 ) = 0 HPC ( 7 ) = 1  
HPC ( 8 ) = 2 HPC ( 9 ) = 1 HPC ( 10 ) = 0 HPC ( 11 ) = 0 HPC ( 12 ) = 1 HPC ( 13 ) = 0 HPC ( 14 ) = 0  
HPC ( 15 ) = 1 HPC ( 16 ) = 1 HPC ( 17 ) = 0 HPC ( 18 ) = 0 HPC ( 19 ) = 1 HPC ( 20 ) = 0 HPC ( 21 ) = 1  
HPC ( 22 ) = 0 HPC ( 23 ) = 0 HPC ( 24 ) = 0 HPC ( 25 ) = 3 HPC ( 26 ) = 0 HPC ( 27 ) = 0 HPC ( 28 ) = 0  
HPC ( 29 ) = 0 HPC ( 30 ) = 0 HPC ( 31 ) = 0 HPC ( 32 ) = 0 HPC ( 33 ) = 0 HPC ( 34 ) = 0 HPC ( 35 ) = 0

BOEING PROPRIETARY

PAGE 6  
PROBLEM NO. 1

ALTERNATE CONFIGURATION USING SSME & OMS KIT

GUIDANCE CONTROL FLAGS

IGUID ( 1 ) = 2 IGUID ( 2 ) = 0 IGUID ( 3 ) = 0 IGUID ( 4 ) = 1 IGUID ( 5 ) = 1 IGUID ( 6 ) = 0 IGUID ( 7 ) = 0  
 IGUID ( 8 ) = 0 IGUID ( 9 ) = 0 IGUID (10) = 0 IGUID (11) = 0 IGUID (12) = 2 IGUID (13) = 1 IGUID (14) = 0  
 IGUID (15) = 0 IGUID (16) = 0 IGUID (17) = 0 IGUID (18) = 0 IGUID (19) = 0 IGUID (20) = 0 IGUID (21) = 0  
 IGUID (22) = 0 IGUID (23) = 0 IGUID (24) = 0 IGUID (25) = 0



BOEING PROPRIETARY

PAGE 31  
PROBLEM NO. 1

ALTERNATE CONFIGURATION USING SSME & OMS KIT

TIME	2.70000000E+02	TIMES	1.20000000E+02	TDURP	1.20000000E+02	DENS	5.000 ***	PRES	5.04883190E-09	ATEM	3.30540424E+02
ALTTIO	2.98517877E+05	GCRAD	2.12242589E+07	GDIAT	3.69848005E+01	GCLAT	3.69848005E+01	LONG	3.69848005E+01	LOHGI	2.62522475E+02
VEI1	2.04323039E+04	GAHHAI	2.49288611E+00	AZVELI	3.81383814E+00	XI	-1.87495938E+06	VXI	1.87495938E+06	AXI	1.34180703E+01
VEI2	2.03875028E+04	GAHHAR	2.49836765E+00	AZVELR	3.41709803E+01	YI	-1.68498379E+07	VYI	1.68498379E+07	AYI	1.20585178E+02
VELA	2.03875028E+04	GAHHAA	2.49836765E+00	AZVELA	3.41709803E+01	ZI	1.27685807E+07	VZI	1.27685807E+07	AZI	1.10011953E+02
GAHAD	-5.07640468E-02	AZVAD	2.28489215E-03	DHHRHG	2.99626455E+02	CRRNG	1.07910524E+00	DPRNG1	2.99628393E+02	DPRHG2	2.99628393E+02
THRUST	4.36036414E+05	HEIGHT	8.71891468E+04	HDOT	9.45218435E+02	MEICOH	3.37810853E+05	HPROP	2.18381468E+04	ASNG	5.00000000E+00
ETA	1.00000000E+00	ETAL	7.45358459E-01	IPHULL	0.	IYHULL	0.	THCPCCH	0.	THCYAN	0.
FIXD	4.36036414E+05	FAYB	-8.86893207E+01	AXB	1.60869996E+02	ALPHA	-2.32714144E+00	ALPDDT	0.	ALPTOT	2.35203463E+00
F1YB	0.	FAYB	0.	AYB	0.	BETA	3.41384992E-01	BETDDT	0.	QALPHA	-2.44180940E+00
F1ZB	0.	FAZB	-9.19254956E+01	AZB	-3.39217781E-02	BHKANG	1.48956225E-02	BHKDDT	0.	QALTOT	2.46792918E+00
CA	8.99196260E-02	CD	8.60610421E-02	DRAG	8.48835309E+01	ROLI	6.09759706E-01	YANR	0.	ROLDD	3.67107971E-03
CH	9.32006934E-02	CL	9.67750249E-02	LIFT	9.54509220E+01	YAMI	9.75706764E-01	P1TR	1.71270586E-01	P1TBD	-2.36018034E-01
CY	0.	HEATRT	1.19243119E+01	TLHEAT	1.57505430E+03	P1TI	-9.48083378E+01	ROLR	0.	YAHBD	-2.74219969E-03
DYHP	1.04927417E+00	HACH	2.28749066E+01	REYHO	3.99413422E+02	ASXI	1.06575555E+01	ASVI	9.57770487E+01	ASZI	1.28811220E+02
TIME	2.70000000E+02	TIMES	1.20000000E+02	ATL	1.69507761E+02	GLR	2.30234223E+03	VIDEAL	2.35099472E+04	DLI	9.14702753E+02
DLR	1.20522656E+03	TVLR	1.69507761E+02	ATL	1.69507761E+02	GLR	2.30234223E+03	VIDEAL	2.35099472E+04	DLI	9.14702753E+02
TVLI	1.53757861E+03	GLI	1.90579606E+03	ATL	1.90579606E+03	GLR	2.30234223E+03	VIDEAL	2.35099472E+04	DLI	9.14702753E+02

TIME	2.77305909E+02	TIMES	1.27305909E+02	TDURP	1.27305909E+02	DENS	5.000 ***	PRES	3.50150481E-09	ATEM	3.40728380E+02
ALTTIO	3.04701581E+05	GCRAD	2.12304426E+07	GDIAT	3.73979684E+01	GCLAT	3.73979684E+01	LONG	3.73979684E+01	LOHGI	2.62525646E+02
VEI1	2.15945268E+04	GAHHAI	2.12936731E+00	AZVELI	3.62613389E+00	XI	-1.85541238E+06	VXI	1.85541238E+06	AXI	1.37566643E+01
VEI2	2.15517742E+04	GAHHAR	2.13359312E+00	AZVELR	3.58923483E-01	YI	-1.67638659E+07	VYI	1.67638659E+07	AYI	1.24292850E+02
VELA	2.15517742E+04	GAHHAA	2.13359312E+00	AZVELA	3.58923483E-01	ZI	1.28942599E+07	VZI	1.28942599E+07	AZI	1.06852981E+02
GAHAD	-4.90789965E-02	AZVAD	2.62659946E-03	DHHRHG	3.24464118E+02	CRRNG	1.22464407E+05	DPRNG1	3.24464349E+02	DPRHG2	3.24464349E+02
THRUST	4.02815896E+05	HEIGHT	8.05500000E+04	HDOT	8.73208496E+02	MEICOH	3.44450000E+05	HPROP	1.51990000E+04	ASNG	5.00000000E+00
ETA	1.00000000E+00	ETAL	6.88574529E-01	IPHULL	0.	IYHULL	0.	THCPCCH	0.	THCYAN	0.
FIXD	4.02815896E+05	FAYB	-6.59002418E+01	AXB	1.60869998E+02	ALPHA	-3.28813977E+00	ALPDDT	0.	ALPTOT	3.30762293E+00
F1YB	0.	FAYB	0.	AYB	0.	BETA	3.58674651E-01	BETDDT	0.	QALPHA	-2.67387475E+00
F1ZB	0.	FAZB	-5.74339562E+01	AZB	-2.29407833E-02	BHKANG	1.33627591E-02	BHKDDT	0.	QALTOT	2.68971821E+00
CA	8.62121279E-02	CD	8.17605745E-02	DRAG	6.24974903E+01	ROLI	6.27621090E-01	YANR	0.	ROLDD	3.62582878E-03
CH	7.51363493E-02	CL	7.99575539E-02	LIFT	6.11192678E+01	YAMI	1.00428075E+00	P1TR	-1.15450483E+00	P1TBD	-2.39587703E-01
CY	0.	HEATRT	1.18287832E+01	TLHEAT	1.66171670E+03	P1TI	-9.65469726E+01	ROLR	0.	YAHBD	-2.88953932E-03
DYHP	8.13187679E-01	HACH	2.38169673E+01	REYHO	2.85174275E+02	ASXI	1.10272929E+01	ASVI	9.96328585E+01	ASZI	1.25820703E+02
TIME	2.77305909E+02	TIMES	1.27305909E+02	ATL	1.70953665E+02	GLR	2.31169100E+03	VIDEAL	2.46854637E+04	DLI	9.14906390E+02
DLR	1.20540306E+03	TVLR	1.70953665E+02	ATL	1.70953665E+02	GLR	2.31169100E+03	VIDEAL	2.46854637E+04	DLI	9.14906390E+02
TVLI	1.54147018E+03	GLI	1.91499576E+03	ATL	1.91499576E+03	GLR	2.31169100E+03	VIDEAL	2.46854637E+04	DLI	9.14906390E+02

END OF PHASE 5.000

BOEING PROPRIETARY

ALTERNATE CONFIGURATION USING SSME & OHS KIT

DEGII PHASE 6.000

1962 U.S. STANDARD ATMOSPHERE MODEL

HEAT RATE CALCULATED USING CHAPMAN'S EQUATION

HEATK1 = 1.00000000E+00 HEATK2 = 1.76000000E+04 HEATK3 = 2.60000000E+04 RU = 1.00000000E+00  
RHOSL = 2.37690000E-03

COMPUTE DOWN AND CROSS RANGE BASED ON RELATIVE GREAT CIRCLES

LATREF = 3.20000000E+01 LOHREF = 2.62500000E+02 AZREF = 0.

COMPUTE CONIC PARAMETERS

AERODYNAMIC COEFFICIENTS SPECIFIED BY DRAG AND LIFT COEFFICIENTS

SREF = 9.40000000E+02 LREF = 1.00000000E+00 LREFY = 0.

PROPULSION CALCULATED FOR 2 ROCKET ENGINES

CALCULATE ETAL TO LIMIT ACCELERATION

ASHAX = 5.00000000E+00

ENGINES USED TO THROTTLE

1  
2

VEHICLE HEIGHT PARAMETERS

HGTSG = 5.43500000E+04 MPLD = 5.00000000E+03 HPROP = 1.51990000E+04 HJETT = 2.12000000E+04  
GO = 3.21740000E+01

NUMBER OF INTEGRALS FOR THIS PHASE = 18

INTEGRATION SCHEME = FOURTH ORDER RUNGE-KUTTA

DI = 1.00000000E+00 PIIC = 1.00000000E+01

USE RELATIVE YAW, PITCH, AND ROLL COMMANDS

ROLPC = 0, 0, 0

PIPPC = -1.15450483E+00, -5.76474754E-02, 0.

YAHPC = 0, 0, 0.

YAHY = 1.00428075E+00 YAMR = 0. DYAN = 0.

PITI = -9.65469726E+01 PITR = -1.15450483E+00 DPITCH = 0. DESN = 0.

ROLI = 6.27621090E-01 ROLR = 0. DROLL = 0. DESH = 0.

THE NEXT EVENT TO OCCUR WILL BE ONE OF THE FOLLOWING

ESH = 7.000 TYPE = PRTRY CRITR = VELI VALUE = 2.58140000E+04

TOL = 1.00000000E-06 MDL = 1

TABLES AND MULTIPLIERS FOR THIS PHASE

CDI = 1.00000000E+00 CLT = 1.00000000E+00 TVCIT, 0. TVC2T, 2.00000000E+00 AELT, 0.

AET, 2.00000000E+00

PROGRAM CONTROL FLAGS

HPC (1) = 2 HPC (2) = 1 HPC (3) = 4 HPC (4) = 2 HPC (5) = 2 HPC (6) = 0 HPC (7) = 1  
HPC (8) = 2 HPC (9) = 1 HPC (10) = 0 HPC (11) = 0 HPC (12) = 1 HPC (13) = 0 HPC (14) = 0  
HPC (15) = 1 HPC (16) = 1 HPC (17) = 0 HPC (18) = 0 HPC (19) = 1 HPC (20) = 0 HPC (21) = 1  
HPC (22) = 0 HPC (23) = 0 HPC (24) = 0 HPC (25) = 3 HPC (26) = 0 HPC (27) = 0 HPC (28) = 0  
HPC (29) = 0 HPC (30) = 0 HPC (31) = 0 HPC (32) = 0 HPC (33) = 0 HPC (34) = 0 HPC (35) = 0



BOEING PROPRIETARY

ALTERNATE CONFIGURATION USING SSNE & OMS KIT

GUIDANCE CONTROL FLAGS

IGUID ( 1 ) =	2	IGUID ( 2 ) =	0	IGUID ( 3 ) =	0	IGUID ( 4 ) =	0	IGUID ( 5 ) =	1	IGUID ( 6 ) =	0	IGUID ( 7 ) =	0
IGUID ( 8 ) =	0	IGUID ( 9 ) =	0	IGUID (10) =	0	IGUID (11) =	0	IGUID (12) =	2	IGUID (13) =	1	IGUID (14) =	0
IGUID (15) =	0	IGUID (16) =	0	IGUID (17) =	0	IGUID (18) =	0	IGUID (19) =	0	IGUID (20) =	0	IGUID (21) =	0
IGUID (22) =	0	IGUID (23) =	0	IGUID (24) =	0	IGUID (25) =	0						

BOEING PROPRIETARY

PROBLEM NO. 34  
PAGE 1

ALTERIATE CONFIGURATION USING SSME & OMS KIT

TIME	2.77305909E+02	TIMES	0.	TDURP	6.000 ***	PRES	2.04795231E-03	ATEM	3.40728380E+02
ALTTIO	3.04701581E+05	GCRAD	2.12304426E+07	GDLAT	3.73979684E+01	LONG	2.62525646E+02	LONGI	2.63684250E+02
VELI	2.15945248E+04	GAINHAI	2.12936731E+00	AZVELI	3.62661338E+00	VXI	2.72532167E+03	AXI	5.28873480E+00
VEIR	2.15517742E+04	GAINHAR	2.13359312E+00	AZVELR	3.58923483E-01	VYI	1.22170037E+04	AYI	4.77843266E+01
VEIA	2.15517742E+04	GAINMAA	2.13359312E+00	AZVELA	3.58923483E-01	VZI	1.75966617E+04	AZI	1.02761083E+01
GAMAD	-3.02256920E-02	AZVAD	4.48436952E-03	DHHRING	3.24466118E+02	DPRIU1	3.24466349E+02	DPRIU2	3.24466349E+02
THURST	6.89999746E+04	HEIGHT	5.93500000E+04	HDOY	1.60129961E+02	WPROG	1.51990000E+04	ASNG	1.16148439E+00
ETA	1.00000000E+00	ETAL	1.00000000E+00	IPHULL	0.	IHCPCB	0.	INCYAH	0.
FIXB	6.89999746E+04	FAYB	-6.59002418E+01	AYB	3.73695857E+01	ALPDDT	0.	ALPTOT	3.30762293E+00
FIZB	0.	FAZB	0.	AZB	0.	BEIDOT	0.	QALPHA	-2.67387475E+00
CA	8.62121279E-02	CD	-5.74339562E+01	DRAG	-3.11353009E-02	BHKDDT	0.	QALPHA	-2.67387475E+00
CH	7.51363493E-02	CI	7.99575539E-02	LIFT	6.24974903E+01	YHR	0.	ROLDD	0.
CY	0.	HEATRT	1.18287832E+01	TLHEAT	6.11192678E+01	PIIR	-1.15450483E+00	PITDD	0.
DYHP	8.13187679E-01	HACH	2.38169673E+01	REYHO	1.66171670E+03	ROIIR	0.	YAHDD	0.

TIME	2.77305909E+02	ALTA	5.58447488E+01	ECCEH	8.71199782E+01	PERIOD	5.84746982E+01	ARGP	2.22467303E+02
EMERG	-4.29873839E+08	SEIJAX	1.63728724E+07	TRUWH	1.74988603E+02	ANGNDM	4.58144742E+11	PGERAD	1.14806846E+07
APORAD	2.12650601E+07	PGCIAT	-4.24011007E+01	PGIOH	8.41131355E+01	TIIMP	3.06753598E+01	TIIMP	2.77993384E+01
ECCAN	1.73179900E+02	HEAHH	1.71146874E+02	PGVEL	3.99056988E+04	APVEL	2.15444483E+04	VCIRC	2.57494775E+04
LARVE	2.61480069E+02								

TIME	2.77305909E+02	TVLR	1.70953465E+02	ATL	2.42260207E+02	VIDEAL	2.46854637E+04	DLI	9.14906390E+02
TVLI	1.54147018E+03	GLI	1.91499376E+03						

TIME	2.80000000E+02	TIMES	2.69409138E+00	TDURP	6.000 ***	PRES	1.82914000E-03	ATEM	3.44228713E+02
ALTTIO	3.06826981E+05	GCRAD	2.12325680E+07	GDLAT	3.75549034E+01	LONG	2.62526906E+02	LONGI	2.63696766E+02
VELI	2.16921417E+04	GAINHAI	2.04878094E+00	AZVELI	3.61684426E+00	VXI	2.73959717E+03	AXI	5.30893745E+00
VEIR	2.16494445E+04	GAINHAR	2.05282329E+00	AZVELR	3.71028510E-01	VYI	1.23546113E+04	AYI	4.80628788E+01
VEIA	2.16494445E+04	GAINMAA	2.05282329E+00	AZVELA	3.71028510E-01	VZI	1.76243326E+04	AZI	1.02986669E+01
GAMAD	-2.97349757E-02	AZVAD	4.50196783E-03	DHHRING	3.33894253E+02	DPRIU1	3.33894253E+02	DPRIU2	3.33894253E+02
THURST	6.89999773E+04	HEIGHT	5.89185953E+04	HDOY	1.60129961E+02	WPROG	1.47675953E+04	ASNG	1.17011307E+00
ETA	1.00000000E+00	ETAL	1.00000000E+00	IPHULL	0.	IHCPCB	0.	INCYAH	0.
FIXB	6.89999773E+04	FAYB	-5.85772688E+01	AYB	3.76647207E+01	ALPDDT	0.	ALPTOT	3.38303645E+00
FIZB	0.	FAZB	0.	AZB	0.	BEIDOT	0.	QALPHA	-2.43945010E+00
CA	8.59003033E-02	CD	-5.02859243E+01	DRAG	-2.74599101E-02	BHKDDT	0.	QALPHA	-2.43945010E+00
CH	7.37415083E-02	CI	8.14270128E-02	LIFT	5.55268356E+01	YHR	0.	ROLDD	2.65421861E+00
CY	0.	HEATRT	1.12815812E+01	TLHEAT	5.36531228E+01	PIIR	-1.30981240E+00	PITDD	-1.15930373E-01
DYHP	7.25446846E-01	HACH	2.38029506E+01	REYHO	1.69283433E+03	ROIIR	0.	YAHDD	-2.91277200E-03

TIME	2.80000000E+02	TVLR	1.71125814E+02	ATL	2.42260242E+02	VIDEAL	2.47866605E+04	DLI	9.14992572E+02
TVLI	1.20551697E+03	GLI	1.91806238E+03						

BOEING PROPRIETARY

ALTERNATE CONFIGURATION USING SSME & OMS KIT

TIME 3.7000000E+02 TIMES 9.26940914E+01 TDURP 6.000 \*\*\* 4.85424165E-10 PRES 3.45794382E-04 ATEM 4.14992012E+02

ALTI10 3.4111573E+05 GCRAD 2.12668526E+07 GDIAT 4.32456860E+01 DEHS 4.32456860E+01 GCLAT 4.32456860E+01 LONCI 2.64149949E+02

TIME 3.76059858E+02 TIMES 9.87539498E+01 TDURP 6.000 \*\*\* 4.81823758E-10 PRES 3.43565646E-04 ATEM 4.15398059E+02

ALTI10 3.41259531E+05 GCRAD 2.12670005E+07 GDIAT 4.36639368E+01 DEHS 4.36639368E+01 GCLAT 4.36639368E+01 LONCI 2.64183484E+02

TIME 3.76059858E+02 TIMES 9.87539498E+01 TDURP 6.000 \*\*\* 4.81823758E-10 PRES 3.43565646E-04 ATEM 4.15398059E+02

ALTI10 3.41259531E+05 GCRAD 2.12670005E+07 GDIAT 4.36639368E+01 DEHS 4.36639368E+01 GCLAT 4.36639368E+01 LONCI 2.64183484E+02

TIME 3.76059858E+02 TIMES 9.87539498E+01 TDURP 6.000 \*\*\* 4.81823758E-10 PRES 3.43565646E-04 ATEM 4.15398059E+02

ALTI10 3.41259531E+05 GCRAD 2.12670005E+07 GDIAT 4.36639368E+01 DEHS 4.36639368E+01 GCLAT 4.36639368E+01 LONCI 2.64183484E+02

TIME 3.76059858E+02 TIMES 9.87539498E+01 TDURP 6.000 \*\*\* 4.81823758E-10 PRES 3.43565646E-04 ATEM 4.15398059E+02

ALTI10 3.41259531E+05 GCRAD 2.12670005E+07 GDIAT 4.36639368E+01 DEHS 4.36639368E+01 GCLAT 4.36639368E+01 LONCI 2.64183484E+02

TIME 3.76059858E+02 TIMES 9.87539498E+01 TDURP 6.000 \*\*\* 4.81823758E-10 PRES 3.43565646E-04 ATEM 4.15398059E+02

ALTI10 3.41259531E+05 GCRAD 2.12670005E+07 GDIAT 4.36639368E+01 DEHS 4.36639368E+01 GCLAT 4.36639368E+01 LONCI 2.64183484E+02

TIME 3.76059858E+02 TIMES 9.87539498E+01 TDURP 6.000 \*\*\* 4.81823758E-10 PRES 3.43565646E-04 ATEM 4.15398059E+02

ALTI10 3.41259531E+05 GCRAD 2.12670005E+07 GDIAT 4.36639368E+01 DEHS 4.36639368E+01 GCLAT 4.36639368E+01 LONCI 2.64183484E+02

TIME 3.76059858E+02 TIMES 9.87539498E+01 TDURP 6.000 \*\*\* 4.81823758E-10 PRES 3.43565646E-04 ATEM 4.15398059E+02

ALTI10 3.41259531E+05 GCRAD 2.12670005E+07 GDIAT 4.36639368E+01 DEHS 4.36639368E+01 GCLAT 4.36639368E+01 LONCI 2.64183484E+02

TIME 3.76059858E+02 TIMES 9.87539498E+01 TDURP 6.000 \*\*\* 4.81823758E-10 PRES 3.43565646E-04 ATEM 4.15398059E+02

ALTI10 3.41259531E+05 GCRAD 2.12670005E+07 GDIAT 4.36639368E+01 DEHS 4.36639368E+01 GCLAT 4.36639368E+01 LONCI 2.64183484E+02

TIME 3.76059858E+02 TIMES 9.87539498E+01 TDURP 6.000 \*\*\* 4.81823758E-10 PRES 3.43565646E-04 ATEM 4.15398059E+02

ALTI10 3.41259531E+05 GCRAD 2.12670005E+07 GDIAT 4.36639368E+01 DEHS 4.36639368E+01 GCLAT 4.36639368E+01 LONCI 2.64183484E+02

TIME 3.76059858E+02 TIMES 9.87539498E+01 TDURP 6.000 \*\*\* 4.81823758E-10 PRES 3.43565646E-04 ATEM 4.15398059E+02

ALTI10 3.41259531E+05 GCRAD 2.12670005E+07 GDIAT 4.36639368E+01 DEHS 4.36639368E+01 GCLAT 4.36639368E+01 LONCI 2.64183484E+02

TIME 3.76059858E+02 TIMES 9.87539498E+01 TDURP 6.000 \*\*\* 4.81823758E-10 PRES 3.43565646E-04 ATEM 4.15398059E+02

# Appendix D

o POST OPTIMIZED PERFORMANCE TRAJECTORY FOR CONCEPT B-3

## POST OPTIMIZED PERFORMANCE TRAJECTORY FOR CONCEPT B-3

Performance calculations and trajectory optimization for Concept B-3 were accomplished through POST (Program to Optimize Simulated Trajectories). The following pages contain sample input and output files. These enclosed results are for the following conditions:

- . HTO Ascent to 50 X 100 N.Mi. Orbit
- . Orbit Inclination = 28.5 Degree
- . SSME Engine @ Approximately 109% Thrust Rating
- . VAC  $I_{Sp}$  = 447/466 1st/2nd Position of Exit Nozzles

```

PSEARCH = 4, / ACCELERATED PROJECTED GRADIENT
SRCHM = .005, / LIMIT ON OPTIMIZATION STEP SIZE
PCTCC = 4, / MAXIMUM NUMBER OF ITERATIONS
MAXITR = 4, / MAXIMUM NUMBER OF ITERATIONS
C *** OPTIMIZATION VARIABLE ***
OPTVAR = 6HWEIGHT, / MAXIMIZE
OPT = 1, / FINAL
OPTPH = 500, / WEIGHT
C *** CONSTRAINT VARIABLES ***
NDEPV = 3, / NUMBER OF TARGET CONSTRAINTS
DEPVR = 5HALTITO, 5HSAMMAI, 5HEVALI,
DEPVAL = 303080, 0,
DEPTL = 200, .05,
DEPRH = 500, 500,
C *** CONTROL VARIABLES ***
MINOV = 16,
INDVR = 5HALPHA,
INDPH = 1, 10, 20, 30, 40, 60, 90, 110, 150,
190, 210, 240, 280, 340, 420,
U = 10., 9.7, 7.9, 4.7, 4.4, 4.1, 4.2, 5.7, 10.4, 19.4,
21.2, 20.8, 16.7, 10.6, 4.2, 1.0,
$PSENDAT
TITLE=3H*OPTIMIZE RASV ASCENT WITH HEATING CONSTRAINT*,
EVENT = 1, / FIRST EVENT
FESV = 500, / FINAL EVENT
NPC(2) = 1, / FOURTH ORDER RUNGE-KUTTA
DI = 5, / INTEGRATION STEP SIZE
PINC = 10,
C *** INITIAL CONDITIONS ***
NPC(3) = 3, / EARTH RELATIVE VELOCITY COMPONENTS
VELA = 600, / INITIAL VELOCITY IN FT/SEC
GAMMA = 0, / INITIAL FLIGHT PATH ANGLE
NPC(4) = 2, / GEOCENTRIC POSITION COMPONENTS
AZVELA = 90, / INITIAL RELATIVE VELOCITY AZIMUTH
ALTITO = 0, / INITIAL ALTITUDE
GCLAT = 28.47, / LAUNCH LATITUDE
LJNG = -80.54, / LONGITUDE
AZL = 90, / AZIMUTH
NPC(5) = 2, / 1952 STANDARD ATMOSPHERE
NPC(7) = 1, / THRUST TO 36
NPC(8) = 2, / CL AND CD AERO INPUTS
SREF = 5800, / REFERENCE AREA
NPC(9) = 1, / ROCKET ENGINES
NEVG = 1, / NUMBER OF ENGINES
ISPV = 147, / SPECIFIC THRUST IN SEC
NPC(12) = 1, / RELATIVE GREAT CIRCLE RANGE
NPC(21) = 1, / FLOWRATE FROM IS*
NPC(25) = 1, / CALCULATE VELOCITY LOSSES
C *** GUIDANCE INPUTS ***
IGUID(1) = 0, / AERO ANGLE STEERING
IGUID(3) = 3, / PIECEWISE LINEAR FUNCTIONS
JGTSG = 1220300, / LAUNCH WEIGHT
ALTMAX = 600030,
MAXTIM = 1500,
    
```

BOEING PROPRIETARY

PRNC=0,  
FID=6HPLJDDAT,  
\*\*\* PRINT BLOCK \*\*\*

PRNT = 6HTIME ,6HWELA ,6HGAMMA,6HWEIGHT,6HINC ,  
6HALPHA ,6HDYMP ,6HWELI ,6HGAMMAI,6HFVALI ,64PSTOP ,

\$  
P\$TBLMLT

\$  
P\$TAB

\$  
TABLE=5HTVCIT,0,1006140, / VAC THRUST

\$  
P\$TAB

\$  
TABLE=4HAELT ,3,58, / AREA RATIO

\$  
P\$TAB

TABLE=3HCLT,2,5HALPHA,4HMACH,9,14,8,1, / CL FOR RASU-ASCENT  
0.3,-2,-.38,0.0,2,-.082,5,.246,13,.41,15,.615,20,.82,25,1.32,30,1.23,  
0.6,-2,-.08,0.0,2,-.082,5,.246,10,.41,15,.615,20,.82,25,1.32,30,1.23,  
0.3,-2,-.09,0.0,2,-.085,5,.258,10,.43,15,.645,20,.86,25,1.37,30,1.29,  
1.3,-2,-.39,0.0,2,-.394,5,.282,10,.47,15,.705,20,.94,25,1.18,30,1.41,  
1.1,-2,-.14,0.0,2,-.098,5,.294,10,.49,15,.735,20,.98,25,1.23,30,1.47,  
1.2,-2,-.14,0.0,2,-.096,6,.288,10,.48,15,.72,20,.96,25,1.23,30,1.44,  
1.5,-2,-.38,0.0,2,-.078,6,.234,10,.39,15,.585,20,.78,25,.99,30,1.17,  
2.3,-2,-.06,0.0,2,-.062,5,.186,10,.31,15,.465,20,.62,25,.775,30,.93,  
2.5,-2,-.05,0.0,2,-.052,5,.155,10,.258,15,.387,20,.515,25,.645,30,.646,  
3.0,-2,-.34,0.0,2,-.043,5,.129,13,.215,15,.323,20,.43,25,.538,30,.646,  
4.3,-2,-.03,0.0,2,-.032,5,.096,10,.16,15,.24,20,.32,25,.43,30,.48,  
5.3,-2,-.03,0.0,2,-.025,6,.078,10,.13,15,.195,20,.26,25,.325,30,.39,  
7.3,-2,-.02,0.0,2,-.022,6,.066,10,.11,15,.165,20,.22,25,.275,30,.33,  
4.0,-2,-.12,0.0,2,-.022,5,.066,10,.11,15,.165,20,.22,25,.275,30,.33,

\$  
P\$TAB

TABLE=3HCDDT,2,5HALPHA,4HMACH,9,16,8,1, / CD FOR RASU-ASCENT  
0.0,-2,-.028,0.0,2,27,2,-.028,6,.038,10,.056,15,.093,20,.145,25,.209,30,.292,  
.25,-2,-.027,0.0,2,26,2,-.027,6,.037,10,.056,15,.093,20,.145,25,.21,30,.294,  
0.5,-2,-.026,0.0,2,25,2,-.026,6,.036,10,.055,15,.093,20,.145,25,.212,30,.297,  
0.6,-2,-.026,0.0,2,25,2,-.025,6,.036,13,.056,15,.095,20,.15,25,.219,30,.306,  
.75,-2,-.025,0.0,2,25,2,-.025,6,.038,10,.061,15,.106,20,.169,25,.248,30,.349,  
1.3,-2,-.042,0.0,2,04,2,-.042,6,.06,10,.094,15,.162,20,.257,25,.301,30,.527,  
1.1,-2,-.056,0.0,2,27,2,-.057,6,.077,10,.118,15,.197,20,.309,25,.455,30,.627,  
1.25,-2,-.36,0.0,2,57,2,-.056,5,.082,10,.125,15,.21,20,.329,25,.482,30,.67,  
1.5,-2,-.053,0.0,2,53,6,.07,10,.104,15,.159,20,.251,25,.382,30,.523,  
2.0,-2,-.047,0.0,2,45,2,-.047,6,.06,10,.088,15,.141,20,.216,25,.312,30,.43,  
3.0,-2,-.04,0.0,2,39,2,-.046,.051,10,.072,15,.113,20,.17,25,.245,30,.335,  
4.0,-2,-.038,0.0,2,38,6,.046,10,.061,15,.091,20,.132,25,.186,30,.251,  
5.3,-2,-.038,0.0,2,37,2,-.038,6,.044,13,.056,15,.08,20,.113,25,.156,30,.208,  
8.3,-2,-.038,0.0,2,37,2,-.039,6,.043,13,.055,15,.077,20,.107,25,.147,30,.195,  
20,-2,-.037,0.0,2,36,2,-.037,6,.042,13,.054,15,.066,20,.106,25,.146,30,.184,  
40,-2,-.037,0.0,2,36,2,-.037,6,.042,13,.054,15,.066,20,.106,25,.146,30,.194,  
ENDPHS = 1,

\$  
P\$GENDAT

EVENT=10,CRITR=4HTIME,VALUE=10,ENDPHS=1,  
NPC(19)=, /NO\_EVENT\_SUMMARY PRINT

\$  
P\$GENDAT

EVENT=20,CRITR=4HTIME,VALUE=20,ENDPHS=1,

\$  
P\$GENDAT

EVENT=30,CRITR=4HTIME,VALUE=30,ENDPHS=1,

```

$ P$GENDAT
EVENT=40,CRITR=4HTIME,VALUE=40,ENDPHS=1,
$ P$GENDAT
EVENT=50,CRITR=4HTIME,VALUE=60,ENDPHS=1,
$ P$GENDAT
EVENT=80,CRITR=4HTIME,VALUE=80,ENDPHS=1,
$ P$GENDAT
C START OF PHASE 2
EVENT=110,CRITR=6HALTITD,VALUE=45000,
ISPV = 466, / ISP UPDATE
$ P$TBLMLT
$ P$TAB
TABLE=5HTVCIT,0,1048930, / THRUST UPDATE
$ P$TAB
TABLE=4HAET,0,164.9, / AREA RATIO UPDATE
ENDPHS=1,
$ P$GENDAT
EVENT=150,CRITR=4HTIME,VALUE=132,ENDPHS=1,
$ P$GENDAT
EVENT=190,CRITR=6HALTITD,VALUE=90000,
NPC(11)=1,
MONF=5HALTITD,
NEOS(1)=-1,
$ P$TBLMLT
$ P$TAB
TABLE=4HFLIT,1,44VEIA,5,1,1,1,
2500,9000,3000,105000,3400,120000,3800,133000,5000,165000,
ENDPHS=1,
$ P$GENDAT
EVENT=210,CRITR=5HALTITD,VALUE=160000,
NPC(11)=0,
ENDPHS=1,
$ P$GENDAT
EVENT=240,CRITR=4HTIME,VALUE=242,ENDPHS=1,
$ P$GENDAT
EVENT=280,CRITR=4HTIME,VALUE=280,ENDPHS=1,
$ P$GENDAT
EVENT=340,CRITR=4HTIME,VALUE=340,ENDPHS=1,
$ P$GENDAT
EVENT=420,CRITR=4HTIME,VALUE=420,
NPC(11) = 1, / CALCULATE CONICS
ENDPHS=1,
$ P$GENDAT

```



BOEING PROPRIETARY

C \*\*\* THIS EVENT MARKS INJECTION INTO ORBIT \*\*\*  
EVENT=509,CRITR=HVELI,VALUE=25890,  
ENDPHS = 1,  
ENDPRB = 1,  
ENDJOB = 1,  
\$

OPTIMIZE RASV ASCENT WITH HEATING CONSTRAINT

BEGIN PHASE 1.000

1952 U.S. STANDARD ATMOSPHERE MODEL

COMPUTE DOWN AND CROSS RANGE BASED ON RELATIVE GREAT CIRCLES  
LATREF = 2.8470000E+01 LONREF = -8.0540000E+01 AZREF = 9.0000000E+01

AERODYNAMIC COEFFICIENTS SPECIFIED BY DRAG AND LIFT COEFFICIENTS  
SREF = 5.8000000E+03 LREF = 1.0000000E+00 DR\_LREF = 0.

PROPULSION CALCULATED FOR 1 ROCKET ENGINES

CALCULATE ETAL TO LIMIT ACCELERATION  
ASHAX = 3.0000000E+00

ENGINES USED TO THROTTLE  
1

VEHICLE WEIGHT PARAMETERS  
WGTS6 = 1.2200000E+05 WPLD = 0. WPROP = 0. WJETT = 0.  
G0 = 3.2174000E+01

NUMBER OF INTEGRALS FOR THIS PHASE = 16  
INTEGRATION SCHEME = FOURTH ORDER RUNGE-KUTTA  
DT = 5.0000000E+00 PINC = 1.0000000E+01

USE\_ANGLE\_OF\_ATTACK, SIDESLIP, AND BANK COMMANDS  
ALPPC = 0. 0. 0. 0. 0. 0.  
BETPC = 0. 0. 0. 0. 0. 0.  
BNRPC = 0. 0. 0. 0. 0. 0.  
ALPHA = 9.93714317E+00 ALPHA = 9.73772066E+00 DESN = 0.  
BETA = 0. OBETA = 0. DESN = 0.  
BNXANG = 0. DBANK = 0. DESN = 0.

THE NEXT EVENT TO OCCUR WILL BE ONE OF THE FOLLOWING  
ESN = 10.000 TYPE = PRIMARY CRITR = TIME VALUE = 1.0000000E+01  
TOL = 1.0000000E-05 MDL = 1

TABLES AND MULTIPLIERS FOR THIS PHASE  
CDT = 1.0000000E+00 CLT = 1.0000000E+00 TWCIT = 1.0000000E+00 AEIT = 1.0000000E+00

PROGRAM CONTROL FLAGS  
NPC ( 1 ) = 0 NPC ( 2 ) = 1 NPC ( 3 ) = 3 NPC ( 4 ) = 2 NPC ( 5 ) = 2 NPC ( 6 ) = 0 NPC ( 7 ) = 1  
NPC ( 8 ) = 2 NPC ( 9 ) = 1 NPC ( 10 ) = 0 NPC ( 11 ) = 0 NPC ( 12 ) = 1 NPC ( 13 ) = 0 NPC ( 14 ) = 0  
NPC ( 15 ) = 0 NPC ( 16 ) = 0 NPC ( 17 ) = 0 NPC ( 18 ) = 0 NPC ( 19 ) = 1 NPC ( 20 ) = 0 NPC ( 21 ) = 1  
NPC ( 22 ) = 0 NPC ( 23 ) = 0 NPC ( 24 ) = 0 NPC ( 25 ) = 1 NPC ( 26 ) = 0 NPC ( 27 ) = 0 NPC ( 28 ) = 0  
NPC ( 29 ) = 0 NPC ( 30 ) = 0 NPC ( 31 ) = 0 NPC ( 32 ) = 0 NPC ( 33 ) = 0 NPC ( 34 ) = 0 NPC ( 35 ) = 0

GUIDANCE CONTROL FLAGS  
IGUID ( 1 ) = 0 IGUID ( 2 ) = 0 IGUID ( 3 ) = 3 IGUID ( 4 ) = 0 IGUID ( 5 ) = 1 IGUID ( 6 ) = 0 IGUID ( 7 ) = 0  
IGUID ( 8 ) = 0 IGUID ( 9 ) = 0 IGUID ( 10 ) = 0 IGUID ( 11 ) = 0 IGUID ( 12 ) = 2 IGUID ( 13 ) = 1 IGUID ( 14 ) = 0  
IGUID ( 15 ) = 0 IGUID ( 16 ) = 0 IGUID ( 17 ) = 0 IGUID ( 18 ) = 0 IGUID ( 19 ) = 0 IGUID ( 20 ) = 0 IGUID ( 21 ) = 0  
IGUID ( 22 ) = 0 IGUID ( 23 ) = 0 IGUID ( 24 ) = 0 IGUID ( 25 ) = 0

BOEING PROPRIETARY

OPTIMIZE RASV ASCENT WITH HEATING CONSTRAINT

THE FILE ID AND PARAMETER LIST FOR THIS DATA FILE ARE

PLDDAT 1000

TIME ALTITD VELA GAMMA WEIGHT INC ALPHA DYNP VELI GAMMAI

TIME 0. ALTITD -1.19209290E-07 VELA 5.00000000E+02 GAMMA 9.68503465E-14 WEIGHT 1.22060000E+06 INC 0.  
ALPHA 9.33714317E+00 DYNP 4.27843254E+02 VELI 1.94036688E+03 GAMMAI -1.07423312E-13 FVALI 0.

\*\*\* PHASE 1.000 \*\*\*  
TIME 1.00000000E+01 ALTITD 2.44164805E+02 VELA 7.71818548E+02 GAMMA 6.09347490E+00 WEIGHT 1.19749128E+06 INC 0.  
ALPHA 9.07377206E+00 DYNP 7.02922026E+02 VELI 2.10943109E+03 GAMMAI 2.22589743E+00 FVALI 0.

END OF PHASE 1.000

OPTIMIZE RASV ASCENT WITH HEATING CONSTRAINT

BEGIN PHASE 420.000

\*\*\* PHASE 420.000 \*\*\*  
 TIME 4.2000000E+02 ALTTD 2.98565231E+05 VELA 1.69576793E+04 GAMMA 3.27427090E-01 WEIGHT 2.82124912E+05 INC 2.85608577E+01  
 ALPHA 4.32597958E+00 DYNP 7.24176531E-01 VELI 1.83354095E+04 GAMMAI 7.66065719E-01 FVALI 0.

\*\*\* PHASE 420.000 \*\*\*  
 TIME 4.3000000E+02 ALTTD 3.00635858E+05 VELA 1.79166151E+04 GAMMA 5.77193472E-01 WEIGHT 2.64531033E+05 INC 2.85551441E+01  
 ALPHA 3.29535612E+00 DYNP 7.14277814E-01 VELI 1.92744672E+04 GAMMAI 5.3652973E-01 FVALI 0.

\*\*\* PHASE 420.000 \*\*\*  
 TIME 4.4000000E+02 ALTTD 3.02088055E+05 VELA 1.88772362E+04 GAMMA 3.72392203E-01 WEIGHT 2.48034570E+05 INC 2.85694370E+01  
 ALPHA 3.43401930E+00 DYNP 7.27521852E-01 VELI 2.02351990E+04 GAMMAI 3.47402130E-01 FVALI 0.

\*\*\* PHASE 420.000 \*\*\*  
 TIME 4.5000000E+02 ALTTD 3.02997885E+05 VELA 1.98393944E+04 GAMMA 2.11126718E-01 WEIGHT 2.32566539E+05 INC 2.85737513E+01  
 ALPHA 3.06207504E+00 DYNP 7.61676129E-01 VELI 2.11972959E+04 GAMMAI 1.97501897E-01 FVALI 0.

\*\*\* PHASE 420.000 \*\*\*  
 TIME 4.6000000E+02 ALTTD 3.03452624E+05 VELA 2.08026672E+04 GAMMA 3.17570892E-02 WEIGHT 2.18062734E+05 INC 2.85781000E+01  
 ALPHA 2.63964215E+00 DYNP 3.15376623E-01 VELI 2.21605152E+04 GAMMAI 3.61348132E-02 FVALI 0.

\*\*\* PHASE 420.000 \*\*\*  
 TIME 4.7000000E+02 ALTTD 3.03558476E+05 VELA 2.17668155E+04 GAMMA 1.28556415E-02 WEIGHT 2.04462961E+05 INC 2.85924944E+01  
 ALPHA 2.21683634E+00 DYNP 8.87187079E-01 VELI 2.31245882E+04 GAMMAI 1.21008161E-02 FVALI 0.

\*\*\* PHASE 420.000 \*\*\*  
 TIME 4.8000000E+02 ALTTD 3.03436358E+05 VELA 2.27315772E+04 GAMMA 2.68297191E-02 WEIGHT 1.91710787E+05 INC 2.85869450E+01  
 ALPHA 1.79377053E+00 DYNP 9.74525792E-01 VELI 2.40892521E+04 GAMMAI 2.53175909E-02 FVALI 0.

\*\*\* PHASE 420.000 \*\*\*  
 TIME 4.9000000E+02 ALTTD 3.03222547E+05 VELA 2.36966866E+04 GAMMA 2.84057281E-02 WEIGHT 1.79753289E+05 INC 2.85914609E+01  
 ALPHA 1.37055570E+00 DYNP 1.07240242E+00 VELI 2.50542554E+04 GAMMAI 2.68565583E-02 FVALI 0.

\*\*\* PHASE 420.000 \*\*\*  
 TIME 4.9859635E+02 ALTTD 3.03079690E+05 VELA 2.45325210E+04 GAMMA 4.87812683E-05 WEIGHT 1.70002226E+05 INC 2.85954309E+01  
 ALPHA 1.034C3491E+00 DYNP 1.15907152E+00 VELI 2.58900000E+04 GAMMAI 4.62235414E-05 FVALI 0.