



FINAL REPORT

Lawrence Transit COA

Lawrence-Douglas County MPO

MPO: March 16, 2017

Lawrence City Commission: March 21, 2017



Table of Contents

| | | Page |
|----------|---|-------------|
| 1 | Introduction..... | 1-1 |
| | Project Background and Goals..... | 1-1 |
| | Guiding Principles..... | 1-2 |
| 2 | Market Analysis..... | 2-1 |
| | Transit Potential..... | 2-2 |
| | Transit Need | 2-10 |
| 3 | Analysis of Existing System | 3-1 |
| | Service Performance | 3-1 |
| | Public Feedback..... | 3-12 |
| | Adherence to Guiding Principles | 3-14 |
| 4 | Development of Service Scenarios..... | 4-1 |
| | Scenario I..... | 4-7 |
| | Scenario II..... | 4-13 |
| | Public Feedback..... | 4-18 |
| 5 | Final Service Recommendations | 5-1 |
| | Proposed Fixed-Route Service Plan..... | 5-1 |
| | Proposed Demand-Response Service Recommendations..... | 5-38 |
| 6 | Fares, Funding, and Governance..... | 6-1 |
| | Overview of Existing System..... | 6-1 |
| | Peer Systems..... | 6-3 |
| | Performance Metrics Benchmarking | 6-4 |
| | Peer Review | 6-8 |
| | Administrative and Revenue Control Procedures | 6-12 |
| | Title VI, Equity, and Fare Impact to Particular Customers | 6-12 |
| | Fare Payment and Collection Technologies..... | 6-13 |
| | ADA Paratransit (T Lift) Eligibility..... | 6-19 |
| | Potential Change to Fare-free System..... | 6-20 |
| | Recommendations | 6-22 |
| 7 | References | 7-1 |

Table of Figures

| | | Page |
|--|---|-------------|
| | Figure ES-1 Weekday Fall/Spring Semester Daytime System Map..... | vi |
| | Figure 2-1 Population Density | 2-3 |
| | Figure 2-2 Employment Density..... | 2-5 |
| | Figure 2-3 Largest Employers (250+ Employees) and Transit Access within ½-mile..... | 2-6 |
| | Figure 2-4 Major Employers | 2-7 |
| | Figure 2-5 Transit Potential Index | 2-9 |
| | Figure 2-6 Older Adults Population Density..... | 2-11 |
| | Figure 2-7 Individuals in Poverty Population Density | 2-13 |
| | Figure 2-8 Persons with Disabilities Population Density | 2-15 |
| | Figure 2-9 Young Adults Population Density | 2-17 |

LAWRENCE TRANSIT COA | TABLE OF CONTENTS
Lawrence-Douglas County MPO

Figure 2-10 | Persons Living in Zero-Vehicle Households Density..... 2-19

Figure 2-11 | Transit Need Index Map..... 2-21

Figure 3-1 | 2016 Published Transit System Map 3-2

Figure 3-2 | Lawrence Transit and KU on Wheels Public Transit Service Characteristics 3-2

Figure 3-3 | 2016-2017 Service Calendar 3-4

Figure 3-4 | Daily Service Performance Statistics by Route 3-6

Figure 3-5 | Service and Cost Statistics on T Lift, Night Line, and JayLift – 2014-2015 3-9

Figure 3-6 | Ridership on T Lift and Night Line Service – 2007-2015..... 3-9

Figure 3-7 | Bus Stop Sign, Lawrence, KS..... 3-9

Figure 3-8 | Stops Requiring Amenities – 25-49 and 50+ Daily Boardings..... 3-11

Figure 3-9 | Examples of Regular Service Intervals 3-15

Figure 3-10 | Example Direct Alignment (Route 6)..... 3-16

Figure 3-11 | Example of Continuous Forward Progress (Route 1)..... 3-16

Figure 3-12 | Example of Circuitous Route Alignment (Route 15) 3-17

Figure 3-13 | Example of a Symmetrical Route Alignment (Route 10)..... 3-18

Figure 3-14 | Example of an Asymmetrical Route Alignment (Route 3)..... 3-18

Figure 4-1 | Identified Service Improvement Opportunities 4-2

Figure 4-2 | Summary of Customer Preferences* 4-4

Figure 4-3 | Origins and Destinations by Census Block Group for Survey Respondents 4-5

Figure 4-4 | Transfer Activity on Lawrence Transit and KUOW (Left – all transfers; Right – first route/last route)..... 4-6

Figure 4-5 | Scenario I System Map 4-8

Figure 4-6 | Scenario I Description of Proposed Service Changes..... 4-9

Figure 4-7 | Scenario I Proposed Schedule and Frequency*..... 4-12

Figure 4-8 | Scenario II System Map 4-14

Figure 4-9 | Scenario II Description of Proposed Service Changes..... 4-15

Figure 4-10 | Scenario II Proposed Schedule and Frequency* 4-17

Figure 4-11 | Scenario Preference of Online Survey Respondents..... 4-20

Figure 5-1 | Recommended “Yellow” Service Day Daytime System Map..... 5-2

Figure 5-2 | Recommended “Yellow” Service Day Evening (7:00 PM-11:00 PM) System Map... 5-3

Figure 5-3 | Recommended “Blue” Service Day System Map..... 5-4

Figure 5-4 | Recommended “Green” Service Day System Map..... 5-5

Figure 5-5 | Proposed Future Route 1 5-6

Figure 5-6 | Proposed Future Route 2 5-7

Figure 5-7 | Proposed Future Route 3 5-8

Figure 5-8 | Proposed Future Route 6 5-9

Figure 5-9 | Proposed Future Route 7 5-10

Figure 5-10 | Proposed Future Route 10 5-11

Figure 5-11 | Proposed Future Route 11 5-12

Figure 5-12 | Proposed Future Route 15 5-13

Figure 5-13 | Proposed Future Route 27 5-15

Figure 5-14 | Proposed Future Route 29 5-16

Figure 5-15 | Proposed Future Route 29S..... 5-17

Figure 5-16 | Proposed Future Route 30..... 5-18

Figure 5-17 | Proposed Future Route 36..... 5-19

LAWRENCE TRANSIT COA | TABLE OF CONTENTS
Lawrence-Douglas County MPO

| | |
|--|------|
| Figure 5-18 Proposed Future Route 38..... | 5-20 |
| Figure 5-19 Proposed Future Route 41..... | 5-21 |
| Figure 5-20 Proposed Future Route 42..... | 5-22 |
| Figure 5-21 Proposed Future Route 43..... | 5-23 |
| Figure 5-22 “Yellow” Service Day Operating Characteristics..... | 5-25 |
| Figure 5-23 “Blue” Service Day Operating Characteristics..... | 5-26 |
| Figure 5-24 “Green” Service Day Operating Characteristics..... | 5-26 |
| Figure 5-25 Comparison of Current and Proposed Annual Revenue Hours of Service..... | 5-27 |
| Figure 5-26 ADA Paratransit Service Area (3/4-mile buffer) of Existing Service..... | 5-28 |
| Figure 5-27 ADA Paratransit Service Area (3/4-mile buffer) of Proposed Service..... | 5-29 |
| Figure 5-28 Subsidized TNC Service in Pinellas County, FL..... | 5-30 |
| Figure 5-29 Potential Future Routes 42 and 44..... | 5-32 |
| Figure 5-30 Proposed Future Route 5..... | 5-32 |
| Figure 5-31 Current In-Fill Route..... | 5-33 |
| Figure 5-32 Latest Departure Times on Transit Systems Comparable to Lawrence Transit..... | 5-34 |
| Figure 5-33 Route 11 – Outbound Weekday Ridership by Trip..... | 5-35 |
| Figure 5-34 Example of Pedestrian-Supportive Street Treatments..... | 5-37 |
| Figure 5-35 DEFAULT Settings for Costing Weights..... | 5-40 |
| Figure 5-36 T Lift Settings for Costing Weights..... | 5-40 |
| Figure 5-37 Demand-response Performance Metrics..... | 5-43 |
| Figure 5-38 Lawrence-Douglas County Regional Provider Service Characteristics..... | 5-45 |
| Figure 6-1 Lawrence Transit Funding Sources (2009-2015)..... | 6-2 |
| Figure 6-2 Lawrence Peer Communities and Transit Systems..... | 6-3 |
| Figure 6-3 Peer Transit Service Benchmarking – Fixed Route Service Only..... | 6-4 |
| Figure 6-4 Fare Comparison of Peer Systems..... | 6-6 |
| Figure 6-5 Benefits and Drawbacks of Magnetic Stripe Technology..... | 6-14 |
| Figure 6-6 Smartcard in Atlanta..... | 6-14 |
| Figure 6-7 Benefits and Drawbacks of Smartcards..... | 6-15 |
| Figure 6-8 TriMet Flash Pass..... | 6-15 |
| Figure 6-9 NICE In-Vehicle Barcode Scanner..... | 6-16 |
| Figure 6-10 Benefits and Drawbacks of Smartphone-Enabled Fare Payment..... | 6-16 |
| Figure 6-11 Off-board Fare Payment in Manhattan..... | 6-17 |
| Figure 6-12 Ticket Vending Machine in Dallas..... | 6-18 |
| Figure 6-13 Annual Ridership, Revenue, and Expense of Fare-Free System and Fare Increase (Estimated)..... | 6-21 |
| Figure 6-14 Matrix of Funding Opportunities..... | 6-25 |

EXECUTIVE SUMMARY

Transit service has evolved quickly in Lawrence. In less than two decades, Lawrence Transit has grown from fewer than ten routes, serving primarily transit-dependent riders, to a coordinated City-University service carrying approximately 20,000 passengers per weekday when the University of Kansas is in session. While Lawrence Transit, and its coordination partner “KU on Wheels,” have incrementally improved service over the years, a comprehensive review of the City’s entire transit network had not been performed prior to this study.

The purpose of the Lawrence Transit Comprehensive Operational Analysis (COA) was to identify the strengths and weaknesses of the existing system, and to develop recommendations that could be used for improving service and meeting future system goals. For a publicly funded transit system, this means serving existing riders better, attracting new riders, and improving productivity to ensure that the system is a good steward of public funds. It is anticipated that Lawrence voters will be asked to consider the reauthorization of dedicated transit funding in 2018, so these goals are particularly important now. Additional topics covered in this document include recommendations on fares, governance, funding, public information/marketing, and paratransit service.

The Lawrence Transit COA consisted of five major work tasks, corresponding to the chapters of this report:

- **Market Analysis:** An assessment of existing and potential demand for transit service based on population and employment density; socio-economic and demographic characteristics; and land use and the built environment (Chapter 2).
- **Analysis of Existing System:** An evaluation of the overall transit system in Lawrence (Chapter 3), as well as detailed diagnostic analyses of each bus route operating within the City (Appendix A).
- **Development of Service Scenarios:** Using findings from the market and system analyses, as well as public and stakeholder input, the study team developed two service redesign scenarios aimed at improving ridership and productivity (Chapter 4).
- **Final Service Recommendations:** A set of recommendations designed to better align service with ridership potential (Chapter 5). Final recommendations incorporated elements of the preliminary service redesign scenarios that were most well-received by stakeholders and members of the public, and reflected feedback provided online and at public meetings.
- **Fares, Funding, and Governance:** A comparison of existing fare policies, funding sources, and governance model to a set of peer systems with similar community characteristics, along with some recommendations for the future (Chapter 6).

At key points in the project, the study team elicited feedback from stakeholders and members of the public. On-board surveys were conducted at the start of the project to gauge service design preferences and priorities. A parallel survey was conducted online in order to reach additional riders and non-riders as well. Public and stakeholder meetings were held after the completion of the market analysis and then again after the development of the preliminary service redesign scenarios. Materials from each meeting were posted online at lawrencetransitstudy.com. Overall, more than 1,000 surveys were completed over the course of the COA study, helping to guide the study team toward the final recommended service redesign scenario illustrated in the proposed weekday service map below (Figure ES-1).

LAWRENCE TRANSIT COA | FINAL REPORT
Lawrence-Douglas County MPO

Figure ES-1 | Weekday Fall/Spring Semester Daytime System Map

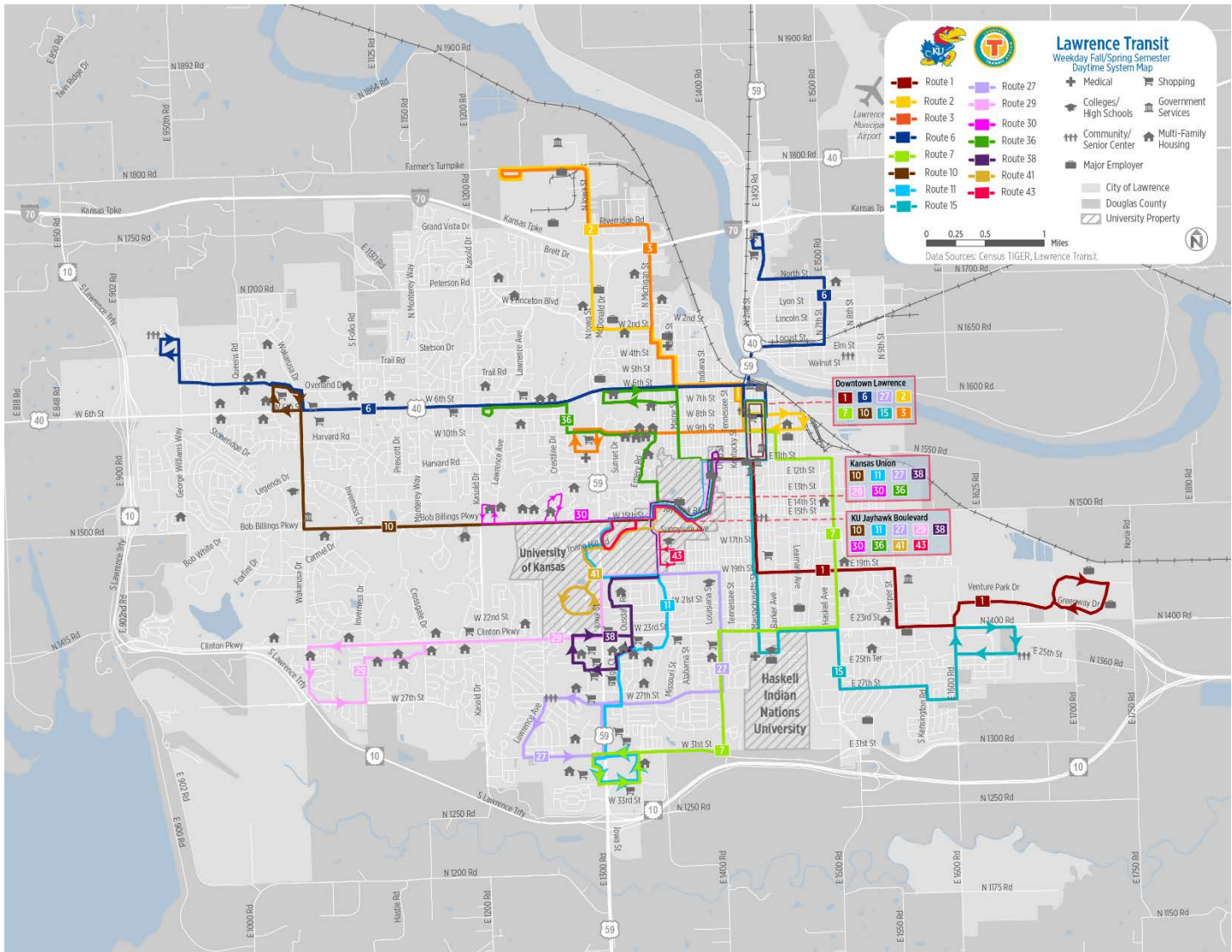

1 INTRODUCTION

PROJECT BACKGROUND AND GOALS

The Lawrence Transit System began operating in its current form in December 2000. A turning point for the system occurred eight years later in 2008/2009. At that time, voters in Lawrence approved a ten-year sales tax to support transit in Lawrence, and the City entered into an agreement with the University of Kansas (KU) to coordinate Lawrence Transit System service with the University's KU on Wheels (KUOW) service.

Dedicated funding and service coordination have allowed the transit providers in Lawrence to make incremental service improvements, resulting both in enhanced mobility for area residents and significant ridership growth (Lawrence Transit ridership increased 157 percent between 2008 and 2014). To build upon recent ridership gains and ensure that transit service in Lawrence continues to respond to the mobility needs of KU students and area residents alike, the City of Lawrence, the University of Kansas, and the Lawrence-Douglas County Metropolitan Planning Organization initiated a Comprehensive Operational Analysis (Lawrence Transit COA) and selected Nelson\Nygaard Consulting Associates to lead the study.

The aim of the Lawrence Transit COA is to identify the strengths and weaknesses of the existing transit network, and to develop recommendations that could be used for improving service and meeting future system goals. For a publicly funded transit system, this means serving existing riders better, attracting new riders, and improving productivity to ensure that the system is a good steward of public funds. It is anticipated that Lawrence voters will be asked to consider the reauthorization of dedicated transit funding in 2018, so these goals are particularly important now. Additional topics covered in this document include recommendations on fares, governance, funding, public information/marketing, and paratransit service.

The Coordinated System (CS) of Lawrence Transit and KU on Wheels (KUOW) offers 18 fixed-route bus routes serving areas throughout the City of Lawrence. In general, Routes 1 through 10, 15, and 27 provide transit coverage to the general Lawrence community as part of Lawrence Transit. Route 27, although operated by the city, terminates on campus and only runs when KU is in session. Routes 30 through 43 are considered KUOW routes and primarily serve students at KU. Routes 11 and 29 are coordinated and provide service to students and the general public. For these coordinated routes, KU and the city share the cost of operation, with KU funding two of the daily vehicles that operate on the routes and the city funding one of the daily vehicles. On weekdays, Route 29 operates with KUOW-branded buses, while Lawrence Transit buses are used on Saturdays. Route 11 operates with Lawrence Transit-branded buses throughout the year.

In this document, the term "Lawrence Transit" will primarily refer to the bus routes serving the general city population and "KUOW" to the bus routes serving students. However, there will necessarily be some overlap in terms because the two systems are now operated jointly. "Lawrence Transit" has in some ways become an umbrella term to refer to the coordinated

system. This document will use terms such as the “Coordinated System” when necessary to provide specificity and reduce confusion.

GUIDING PRINCIPLES

Transit services are most successful when they are easy to use and intuitive to understand. Many elements that increase transit usability are directly related to network design and scheduling. With the overall goals of the COA being to serve existing riders better, attract new riders, and improve productivity, Nelson\Nygaard followed a set of guiding principles to evaluate the existing system and develop a plan for achieving the stated goals. Therefore, the analysis and recommendations presented in this document are grounded in the set of guiding principles listed below. These principles are designed to create a simple, yet highly functional transit system. However, the recommendations are not without exceptions and should only be pursued upon consideration of local conditions.

- **Service Should Operate at Regular Intervals:**
 - In general, people can easily remember repeating patterns, but have difficulty remembering irregular sequences.
- **Routes Should Operate Along a Direct Path:**
 - The fewer directional changes a route makes, the easier it is to understand. Circuitous alignments are disorienting and difficult to remember.
- **Routes Should Be Symmetrical:**
 - Routes should operate along the same alignment in both directions to make it easy for riders to know how to get back to where they came from.
- **Routes Should Serve Well Defined Markets:**
 - Routes should include strong anchors, and a mix of origins and destinations.
- **Service Should Be Well Coordinated:**
 - At major transfer locations, schedules should be coordinated to the greatest extent possible to minimize connection times for the predominant transfer flows.

2 MARKET ANALYSIS

For public transit systems to operate efficiently (for example, in terms of ridership per revenue hour), the system needs to serve dense population and employment centers. However, transit is a public service and must also provide mobility for those who have no other means of transportation in a variety of operating environments. As the City and KU looks towards the future, they must understand where existing and potential customers live and work, and align transit services and programs with those markets. The market analysis helps determine the need and potential for transit service by examining the following characteristics:

- **Population and Employment Density:** The market for transit is strongest in areas with greater numbers of people living and working in close proximity. Population and employment density are thus the strongest indicators of transit demand.
- **Socio-Economic Characteristics:** Factors such as income, auto availability, age, and disability status are often directly related to the likelihood that an individual will use transit to meet their mobility needs.
- **The Location of Major Employment Centers:** Many riders rely on transit for commuting to work. Major employers may also act as partners for funding existing and additional transit services.

Each of these factors indicates demand for transit, but ridership is also affected by urban form, land use, and the pedestrian environment, as well as the cost and convenience of other alternatives. For example, nearly all transit riders are also pedestrians on at least one end of their trip. Thus, the safety and comfort of the walking environment strongly affects ridership. The 2013 Fixed Route Transit and Pedestrian Accessibility Study¹ addressed these pedestrian issues. The City of Lawrence has also had the good fortune of little traffic congestion and ample (and cheap) parking. While these characteristics make Lawrence an attractive place to live and work, they make Lawrence Transit's goal of attracting more ridership difficult to achieve. Areas with few obstacles or "pain points" for drivers have a greater challenge attracting transit riders than areas where using a car is costly in terms of time, money, and hassle.

The Market Analysis presented in this chapter is a starting point in assessing the optimal role of transit service in the study area. The Market Analysis broadly identifies regions, neighborhoods, and activity centers that may be supportive of transit service.

Data sources for this analysis include the 2010 U.S. Census, the 2010-2014 5-year American Community Survey, Lawrence Transit and KUOW data, and economic development data provided by the Economic Development Corporation of Lawrence & Douglas County. For each sub-analysis described below, the smallest available geographic unit was used (blocks for population and employment, block groups for all other socio-economic data). However, it should be noted that population figures are distributed evenly across each geographic area, regardless of how the population is actually distributed (for example, the actual population of a Census block may be concentrated in one large building, rather than across the entire block as shown). In addition,

employment data from the U.S. Census can lack locational accuracy for businesses with multiple locations. Often, employment locations will be reported at the headquarters when the employee actually travels to a satellite location, such as with school teachers and city employees.

TRANSIT POTENTIAL

The market for transit is strongest in areas with a high concentration of people and businesses. Residential and employment density were used to develop a transit potential index. This index shows where the conditions are most suitable for transit service based on the number of people and jobs per acre.

Population Density

As most riders must walk between their origin/destination and the nearest bus stop, population distribution and density is a key factor influencing transit service viability. Higher density communities have more people within walking distance of bus routes, and are thus strong markets for transit.

Most people are willing to walk up to 10 minutes, or between $\frac{1}{4}$ - and $\frac{1}{2}$ -mile, to access bus service. The size of a transit market is therefore directly related to the population density within $\frac{1}{2}$ -mile of a potential transit corridor. The density needed to support hourly fixed-route transit service is generally about 6-15 people per acre. Higher density areas can support higher service frequency, while lower density areas may only be able to support demand response service.

Figure 2-1 shows population density within the City of Lawrence. Key findings from the population density analysis include:

- About 92 percent of the population in the City of Lawrence lives within $\frac{1}{2}$ -mile of existing transit routes. Note: Some individuals may in reality live slightly farther than $\frac{1}{2}$ -mile from existing fixed-route service. The study team conducted this analysis using Census blocks, the smallest geographic unit for which population data is available. However, the edges of the blocks and the $\frac{1}{2}$ -mile buffer “service area” around the routes often do not overlap. Thus, portions of the blocks are outside of the service area.
- The City of Lawrence contains large areas of moderate population density (5-15 people per acre) intermixed with both lower and higher density neighborhoods.
- Lawrence’s highest density neighborhoods are located directly adjacent to the KU campus, including Oread, Hill Crest, and West Hills. These neighborhoods contain a mix of single family housing and larger developments that are popular with KU students. Some parts of Oread have greater than 30 residents per acre and could therefore support higher frequency transit services.
- Apart from neighborhoods near KU, the highest density area in Lawrence is located southeast of the intersection of US-59/Iowa Street and 23rd Street. Several apartment complexes in this neighborhood have more than 30 residents per acre.
- Lawrence’s lowest density neighborhoods are primarily located on the outskirts of the city, especially to the west of KU. These neighborhoods contain mostly single family homes, many of which have been constructed in the past few decades.

LAWRENCE TRANSIT COA | MARKET ANALYSIS

Lawrence-Douglas County MPO

Figure 2-1 | Population Density

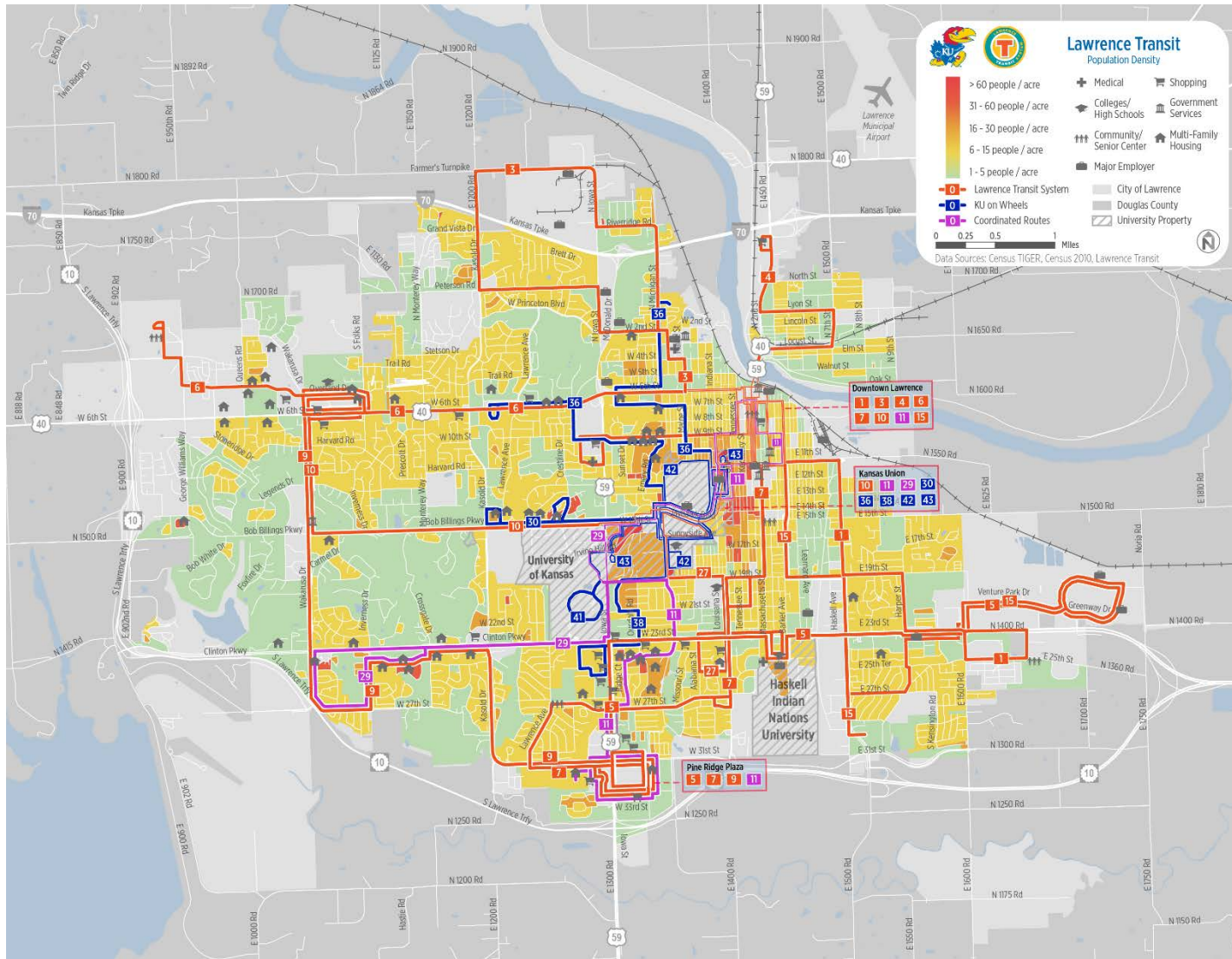

Employment Density

The location and density of jobs is another strong indicator of transit demand. In most markets, traveling to and from work is the single largest segment of transit trips. Commute trips are typically repetitive and predictable, often attracting riders who would otherwise not use transit. As with population density, areas with six or more employment positions per acre can usually support hourly fixed-route transit service. Places with higher employment densities may support greater frequency service.

Figure 2-2 shows employment densities within the City of Lawrence. Key findings from the employment density analysis include:

- The highest concentrations of employment in Lawrence are located downtown and at the University of Kansas, as well as along the corridors of West 6th Street, West 23rd Street, and along Iowa Street south of West 23rd Street. All of these areas are served by Lawrence Transit or KUOW.
- Several institutional complexes are major employment centers, including the Lawrence Memorial Hospital. These locations are accessible using Lawrence Transit services.
- The 2010 Census typically assigns university employment data to a single block. Therefore, much of the KU and Haskell Indian Nations University (HINU) campuses appear to have no employment despite relatively high employment density.

An analysis of several years of employment data (confirmed by local officials) indicates that some anomalies exist in the data. For example, areas in north Lawrence and near West 6th Street and Iowa Street both show high concentrations of employment, but local knowledge suggests that this high concentration may not actually exist. The general trends and findings discussed here are correct, however, and the data anomalies were considered in the development of service recommendations for these areas.

LAWRENCE TRANSIT COA | MARKET ANALYSIS

Lawrence-Douglas County MPO

Figure 2-2 | Employment Density

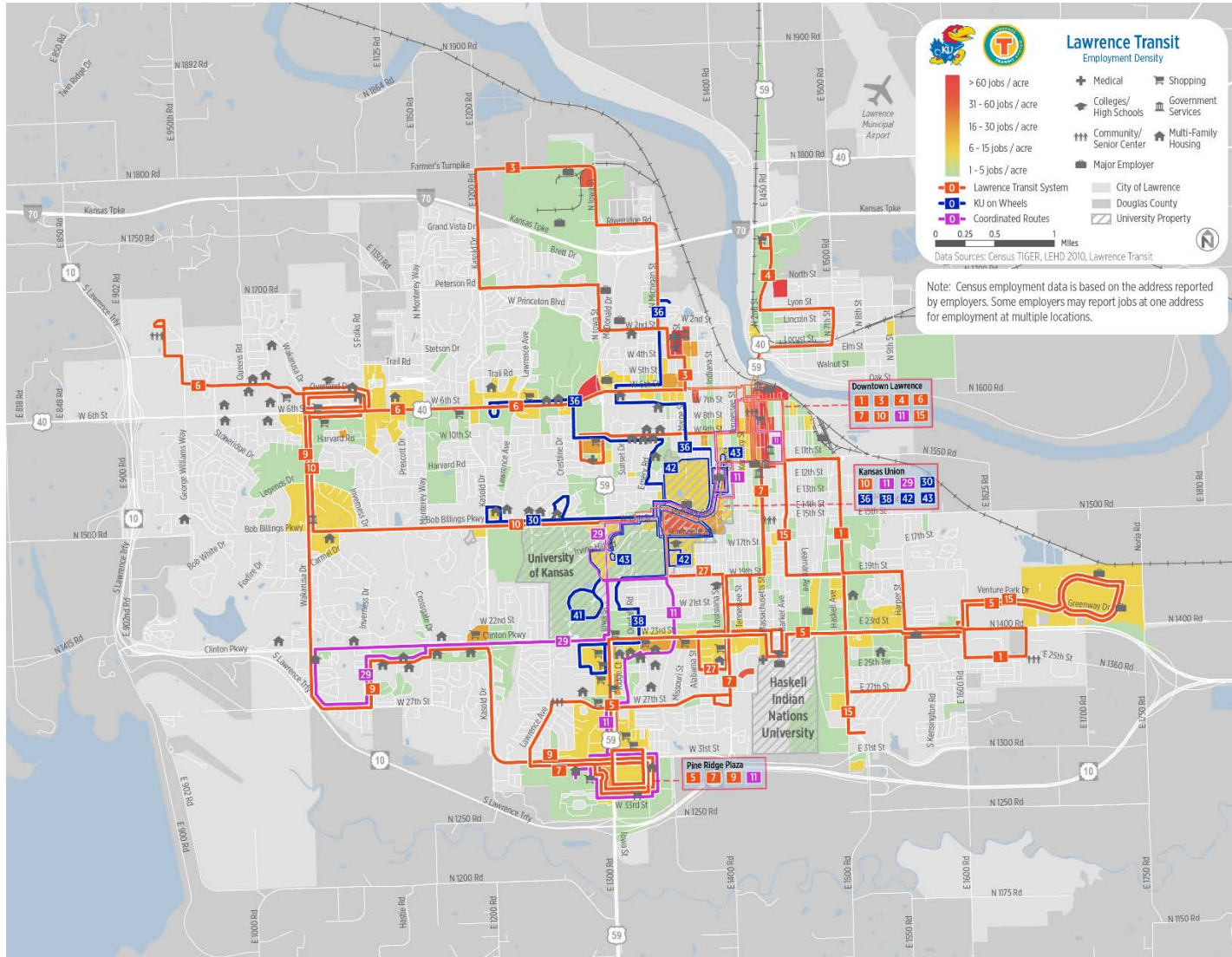

Major Employers

Identifying large employers in the Lawrence area is useful, not only because of the large concentration of jobs they represent, but also because of the marketing and other partnership opportunities that they may offer. Partnerships such as employer-supported transit passes, management associations (for example, areas like downtown, East Hills, HINU, KU, Lawrence Memorial Hospital, and North Lawrence), and on-site transit coordinators can attract choice riders to a transit system and translate into higher system ridership overall.

The largest employers in Lawrence are primarily educational institutions, as well as several major industrial corporations (see Figure 2-3). The University of Kansas, which employs over 9,500 staff, is the largest employer in the City. Haskell Indian Nations University employs 250 staff on its campus. Both universities are served by multiple Lawrence Transit and KUOW bus routes.

Lawrence Memorial Hospital employs more than 1,300 medical professional and support staff at its campus north of West 4th Street between Iowa and Maine Streets. Vangent anchors a manufacturing employment cluster to the southeast of Lawrence. Both of these employment hubs are served by Lawrence Transit. Berry Plastics, K-Mart Distribution Center, Hallmark Cards, Inc., and several other manufacturing and distribution facilities are located along North Iowa Street and Farmer’s Turnpike near I-70. This area is a growing employment center and is currently served by Route 3.

In addition to large individual employers, Lawrence has several major retail districts with significant concentrations of small employers. These districts include The Malls Shopping Center on West 23rd Street, the Hillcrest Shopping Center at 9th and Iowa Streets, Bauer Farm Shopping Center on West 6th Street, and Pine Ridge Plaza near 33rd and Iowa Streets. Each of these retail districts are currently served directly or in close proximity by two or more bus routes.

Figure 2-3 | Largest Employers (250+ Employees) and Transit Access within ½-mile

| Employer | Employees | Transit Access | Employer | Employees | Transit Access |
|----------------------------|-----------|----------------|-----------------------------------|-----------|----------------|
| University of Kansas | 9,881 | Yes | Douglas County | 435 | Yes |
| Lawrence Public Schools | 1,650 | Yes | Boston Financial Data Services | 394 | Yes |
| Vangent | 1,500 | Yes | The Olivia Collection | 320 | Yes |
| City of Lawrence | 1,455 | Yes | K-Mart Distribution Center | 320 | Yes |
| Lawrence Memorial Hospital | 1,322 | Yes | DCCCA | 295 | Yes |
| Berry Plastics | 739 | Yes | Allen Press | 275 | Yes |
| Hallmark Cards, Inc | 525 | Yes | Community Living Opportunities | 263 | Yes |
| Amarr Garage Doors | 461 | Yes | Haskell Indian Nations University | 250 | Yes |

Source: EDC of Lawrence & Douglas County

LAWRENCE TRANSIT COA | MARKET ANALYSIS

Lawrence-Douglas County MPO

Figure 2-4 | Major Employers

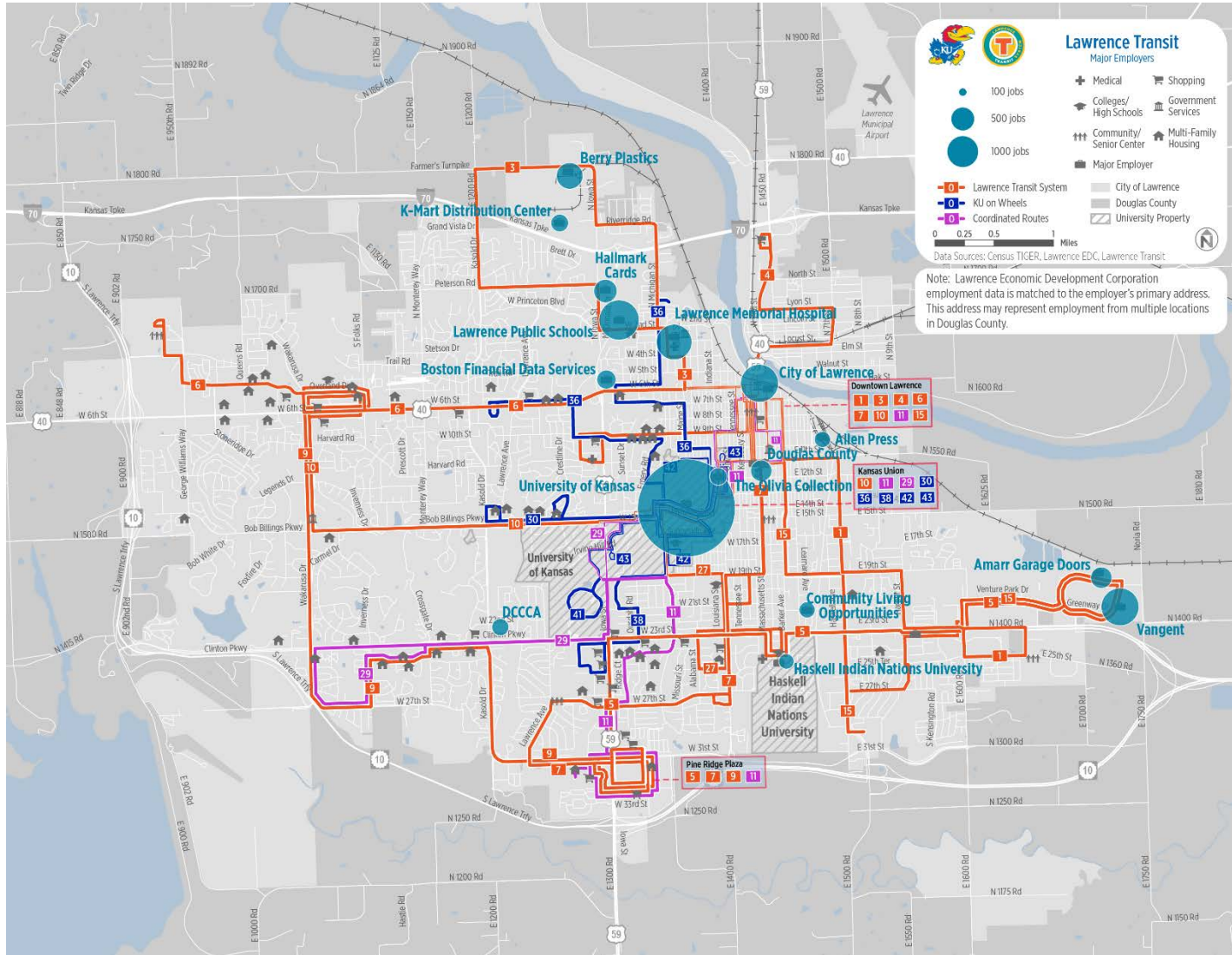

Transit Potential Index

The Transit Potential Index is a composite of population and employment density that helps identify potential transit-supportive neighborhoods and corridors. Areas with higher Transit Potential Index scores are more likely to support fixed-route transit services. To reach their full potential, however, high-scoring areas must also have transit-supportive land uses and infrastructure.

Figure 2-5 shows the Transit Potential Index scores for neighborhoods in Lawrence. Key findings from the Transit Potential Index analysis include:

- Transit potential in Lawrence is particularly high within downtown Lawrence, the Oread neighborhood, and adjacent to the University of Kansas.
- Other high transit potential areas in Lawrence include apartment and office complexes along the West 6th Street corridor as well as some apartments and retail areas south of KU near the intersection of West 23rd Street and Iowa Street.
- Many of the neighborhoods within Lawrence proper have low to moderate transit potential for fixed route service, including much of the area previously covered by the Route 3 North Flex Service and currently covered by the fixed Route 3.
- Underdeveloped areas on the outer reaches of Lawrence show some potential to support transit service. These areas primarily consist of single family housing on poorly connected roadways, which typically are difficult to serve with fixed-route transit.
- The area in the southeast of Lawrence is expecting significant residential and employment growth in part due to the expansion of K-10 South Lawrence Trafficway.
- The area surrounding Rock Chalk Park (RCP) to the northwest has in recent years seen considerable development of apartments between Walmart and RCP, and has the potential for significant additional development. Future demand may warrant higher levels of service than provided today.

LAWRENCE TRANSIT COA | MARKET ANALYSIS

Lawrence-Douglas County MPO

Figure 2-5 | Transit Potential Index

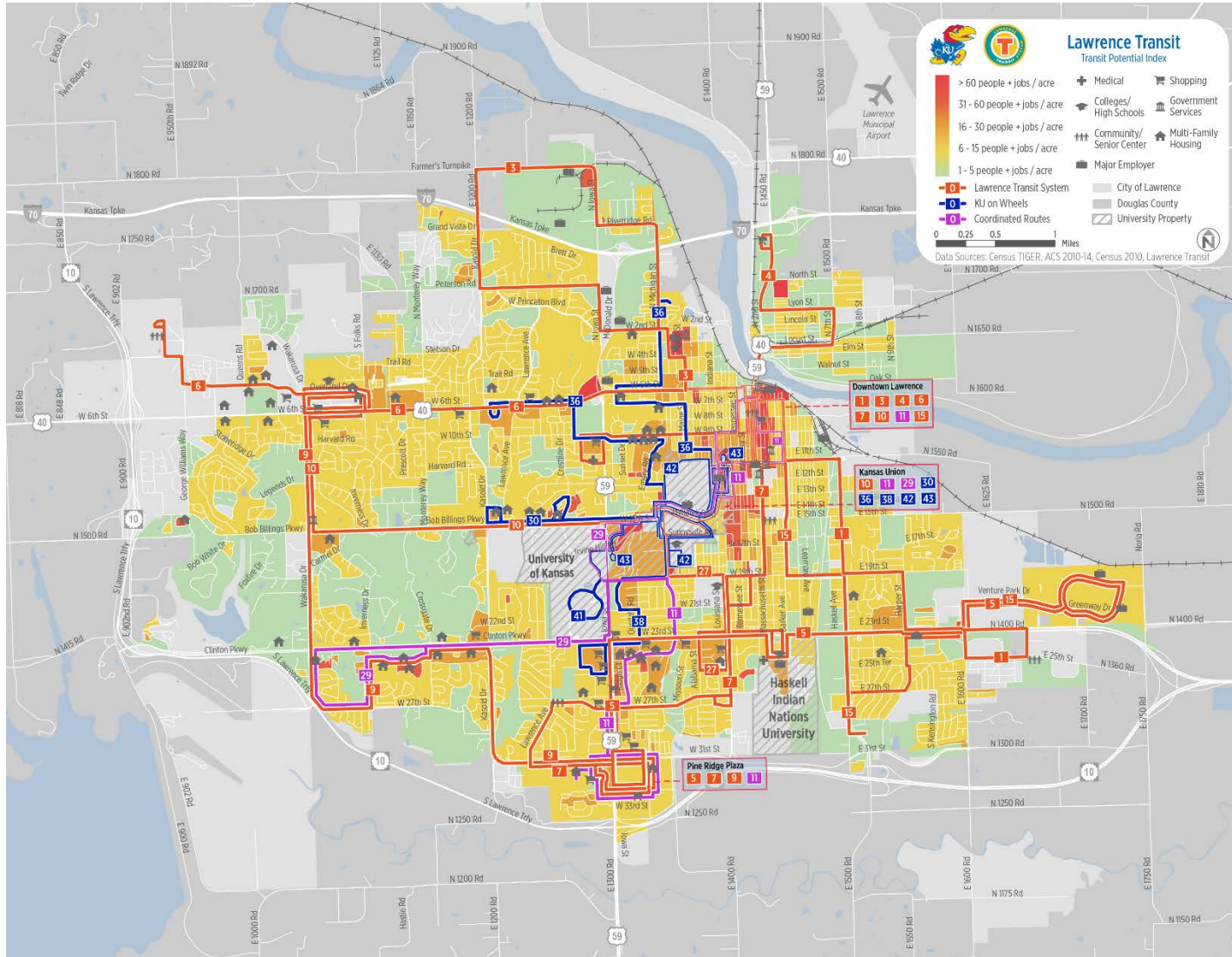

TRANSIT NEED

Above all else, public transportation is a mobility tool. Certain population subgroups are more likely to rely on transit for mobility than the general population. These groups include:

- **Older Adults**, who often become less comfortable or less able to operate a vehicle as they age.
- **Individuals in Poverty**, who often rely on transit as a less expensive alternative to owning a car.
- **Persons with Disabilities**, who may not be able to drive or have difficulty driving.
- **Young Adults**, who in general have a high interest in using a range of transportation options, including transit, walking, and biking, rather than relying on driving alone.
- **Persons Living in Zero-Vehicle Households**, who often regularly or exclusively rely on transit for mobility.

Identifying areas with relatively high concentrations of these groups (see Figure 2-6 through Figure 2-10) can help determine which neighborhoods and corridors have the greatest need for transit service. However, high transit need does not necessarily mean that traditional fixed-route services will work in a given area. Some locations have a relatively high transit need but low transit potential due to lack of density. These areas might benefit from demand-response or other more flexible service types, but are unlikely to support traditional fixed-route service.

Older Adults

Older adults (65 and older) are more likely to use transit than the general population but also tend to use transit less frequently than a regular transit rider under 65. Many seniors are retirees, and as a result, take fewer daily trips. Some must, or choose to, stop driving due to health issues. Others simply prefer a car-free lifestyle. Transit provides an important means for older adults to remain as active and independent as possible, and to age in place.

Only two neighborhoods in Lawrence have greater than one older adult per acre (see Figure 2-6). Both neighborhoods contain large senior living facilities that are directly served by Lawrence Transit bus routes. More recent efforts of the City of Lawrence to attract older adults to Lawrence could increase the demand for transit throughout the community.²

LAWRENCE TRANSIT COA | MARKET ANALYSIS

Lawrence-Douglas County MPO

Figure 2-6 | Older Adults Population Density

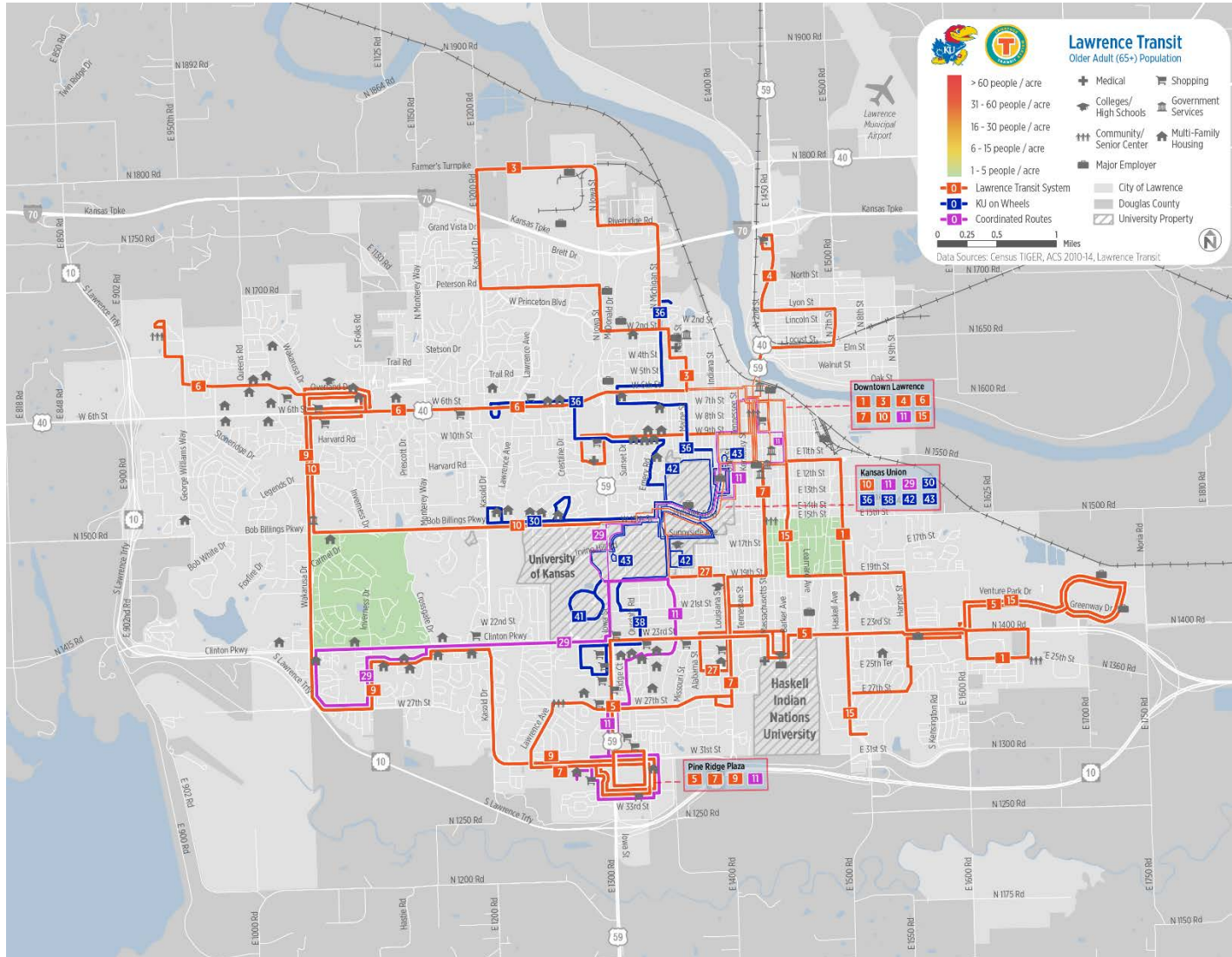

Individuals in Poverty

Many individuals living in poverty do not have consistent access to a vehicle, often because they lack the financial resources to purchase, fuel, and maintain a car. Individuals with low incomes may also live in households with fewer cars than higher-income households. Public transportation can therefore significantly enhance mobility for persons living in poverty, and can be essential for ensuring reliable access to employment opportunities.

The Oread neighborhood, located between downtown and the KU campus, has the greatest density of low income individuals in Lawrence, largely due to a high student population (see Figure 2-7). Students often do not have much income and do not report guardian support, stipends, or other financial aid, and so while they may have a low income, they are not truly living in poverty. The Oread neighborhood might also show different characteristics when school is not in session, but Census data is sampled throughout the year. Recommendations for transit service will consider these factors. Residents living in poverty are otherwise lightly dispersed throughout Lawrence, especially in neighborhoods surrounding downtown and south of KU. All neighborhoods with greater than one person in poverty per acre are served by transit.

LAWRENCE TRANSIT COA | MARKET ANALYSIS

Lawrence-Douglas County MPO

Figure 2-7 | Individuals in Poverty Population Density

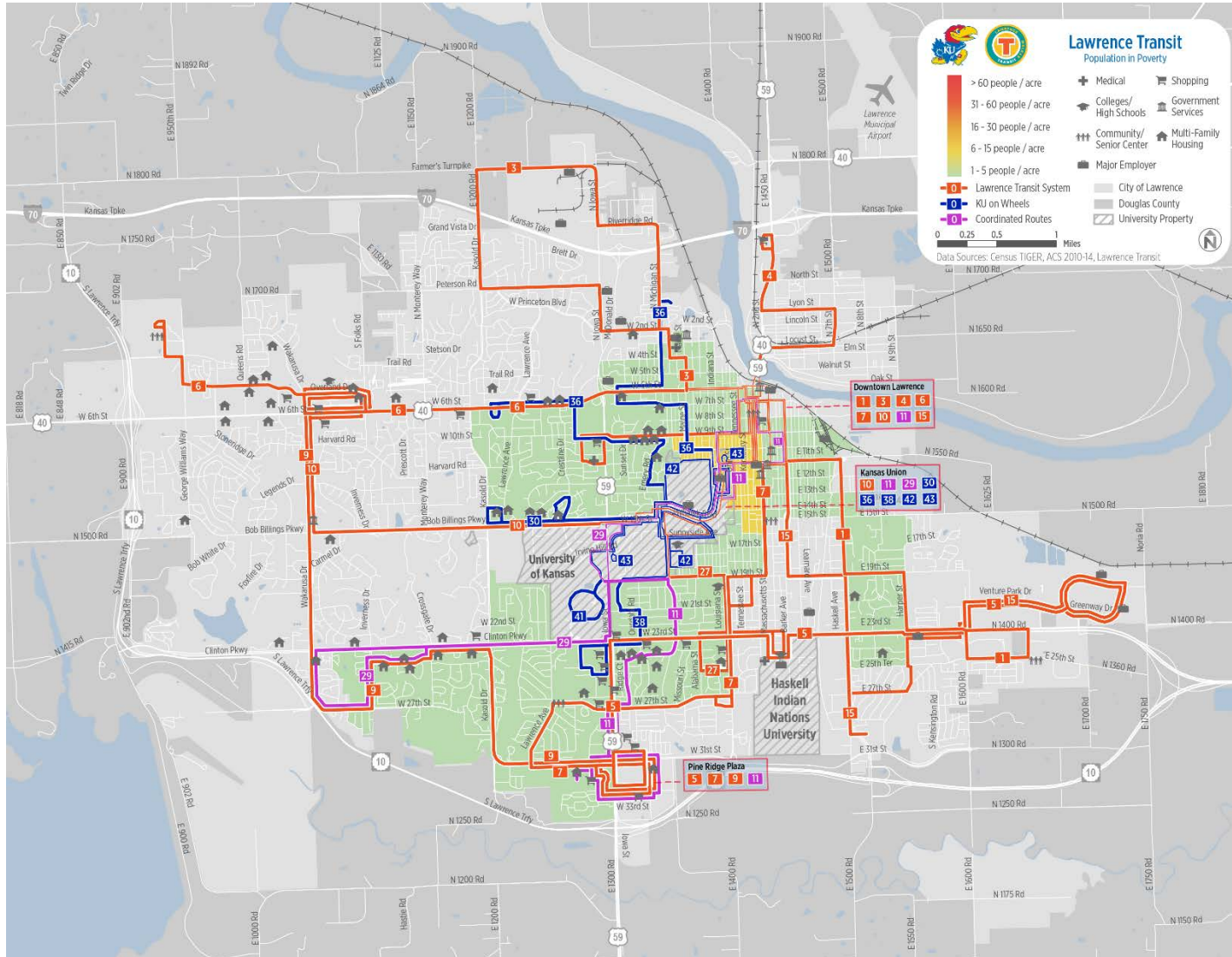

Persons with Disabilities

Persons with disabilities often rely on public transit and other specialized transportation resources for mobility. Most individuals classified as disabled are eligible for T Lift and JayLift, Lawrence Transit's and KUOW's paratransit service, respectively. In recent years, many transit agencies have worked to enhance the accessibility of fixed-route services for the disabled population, reducing reliance on paratransit services. Increased fixed-route accessibility allows disabled riders to travel more spontaneously but also requires that they are able to navigate to a nearby bus stop and onto a transit vehicle. For transit operators, shifting more trips from paratransit to fixed-route services can reduce costs and increase service productivity. For these benefits to occur however, transit agencies must work to ensure that fixed-route services are both physically and geographically accessible to the disabled population.

There are few neighborhoods within the city with greater than one person with disabilities per acre (see Figure 2-8). Concentrations of disabled individuals are located north of KU, near Edgewood Park, and south of 23rd Street between US-59/Iowa Street and Louisiana Street. All neighborhoods with a notable disabled population are currently served by Lawrence Transit or KUOW bus routes.

LAWRENCE TRANSIT COA | MARKET ANALYSIS

Lawrence-Douglas County MPO

Figure 2-8 | Persons with Disabilities Population Density

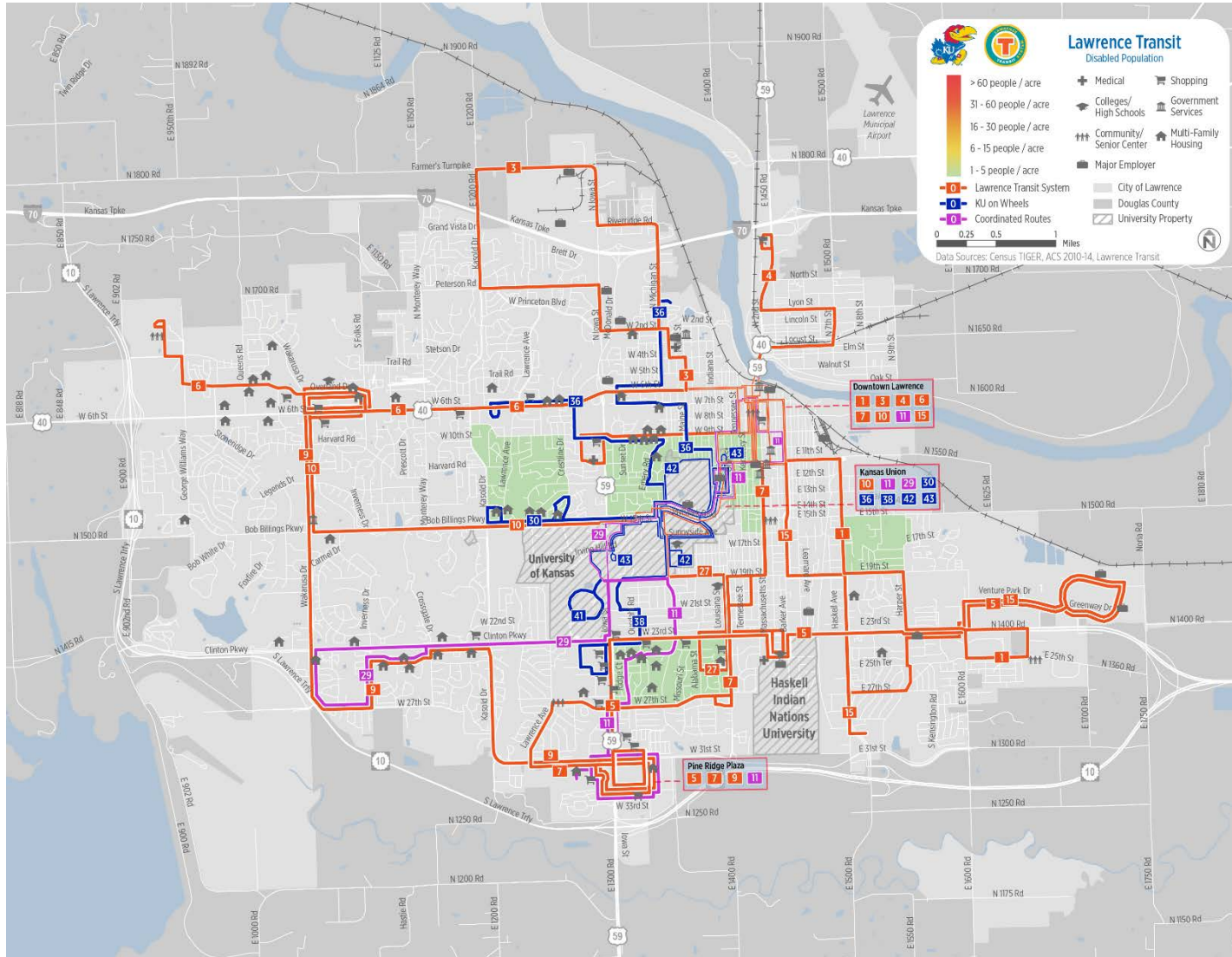

Young Adults

Many young adults (15 to 21 years old) lack access to private vehicles and are therefore more likely to rely on public transportation. Some young adults are not legally able or choose not to acquire a driver's license. Young adults are also increasingly seeking alternative transportation options, such as walking, biking, and transit. A recent survey by Transportation for America and the Rockefeller Foundation (April 2014)³ reported that more than half of Millennials prefer to live in a place where they are not required to rely on cars to get around. Two-thirds of those polled said access to high quality transportation options will be one of their top three criteria when deciding where to live.

The young adult population is primarily concentrated on the KU campus, as well as in residential neighborhoods directly surrounding campus (see Figure 2-9). As many students do not declare residency when attending college, it is likely that the young adult population in these neighborhoods is greater than recorded in the US Census. Apart from these areas, the young adult population is lightly dispersed throughout the city, including in neighborhoods in southern Lawrence. All neighborhoods with a notable young adult population are served by Lawrence Transit or KUOW.

The concentration of young adults in KU's Central and West Districts (as defined by the 2014-2024 Campus Master Plan) in Figure 2-9 is an example of how Census data can be somewhat misleading. The Census block group is "T" shaped and straddles Iowa Street to cover both districts. The residence halls are mostly concentrated just east of Iowa Street between West 15th and West 19th Streets on Daisy Hill, however. The young adult population density of the Central District is approximately 25 people per acre when the West District is excluded, meaning that the Central District would show as orange on the maps.

LAWRENCE TRANSIT COA | MARKET ANALYSIS

Lawrence-Douglas County MPO

Figure 2-9 | Young Adults Population Density

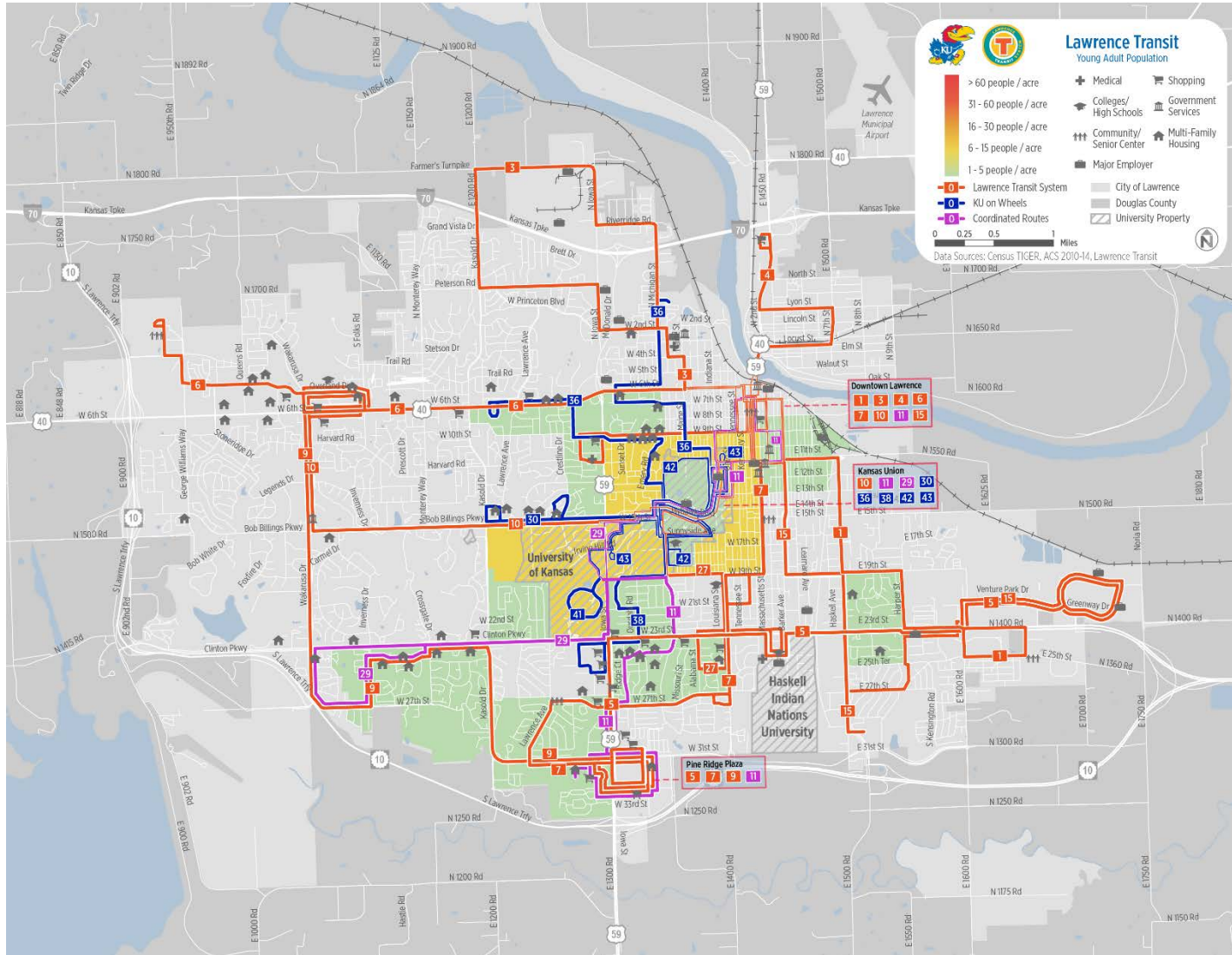

Persons Living in Zero-Vehicle Households

Individuals living in a household that does not own a private vehicle have a high propensity to use transit services. While many of these individuals rely on borrowing a private vehicle or carpooling as their primary means of transportation, they also typically use transit for a significant proportion of trips. For individuals without consistent private vehicle access, nearby public transit services are frequently the only mobility option.

Few areas within Lawrence have notable concentrations of persons living in a zero-vehicle household (see Figure 2-10). The Oread neighborhood, as well as two residential areas near the intersection of US-59/Iowa Street and 23rd Street, are the only areas with greater than one zero vehicle household per acre. All of these neighborhoods are served by Lawrence Transit or KUOW.

LAWRENCE TRANSIT COA | MARKET ANALYSIS

Lawrence-Douglas County MPO

Figure 2-10 | Persons Living in Zero-Vehicle Households Density

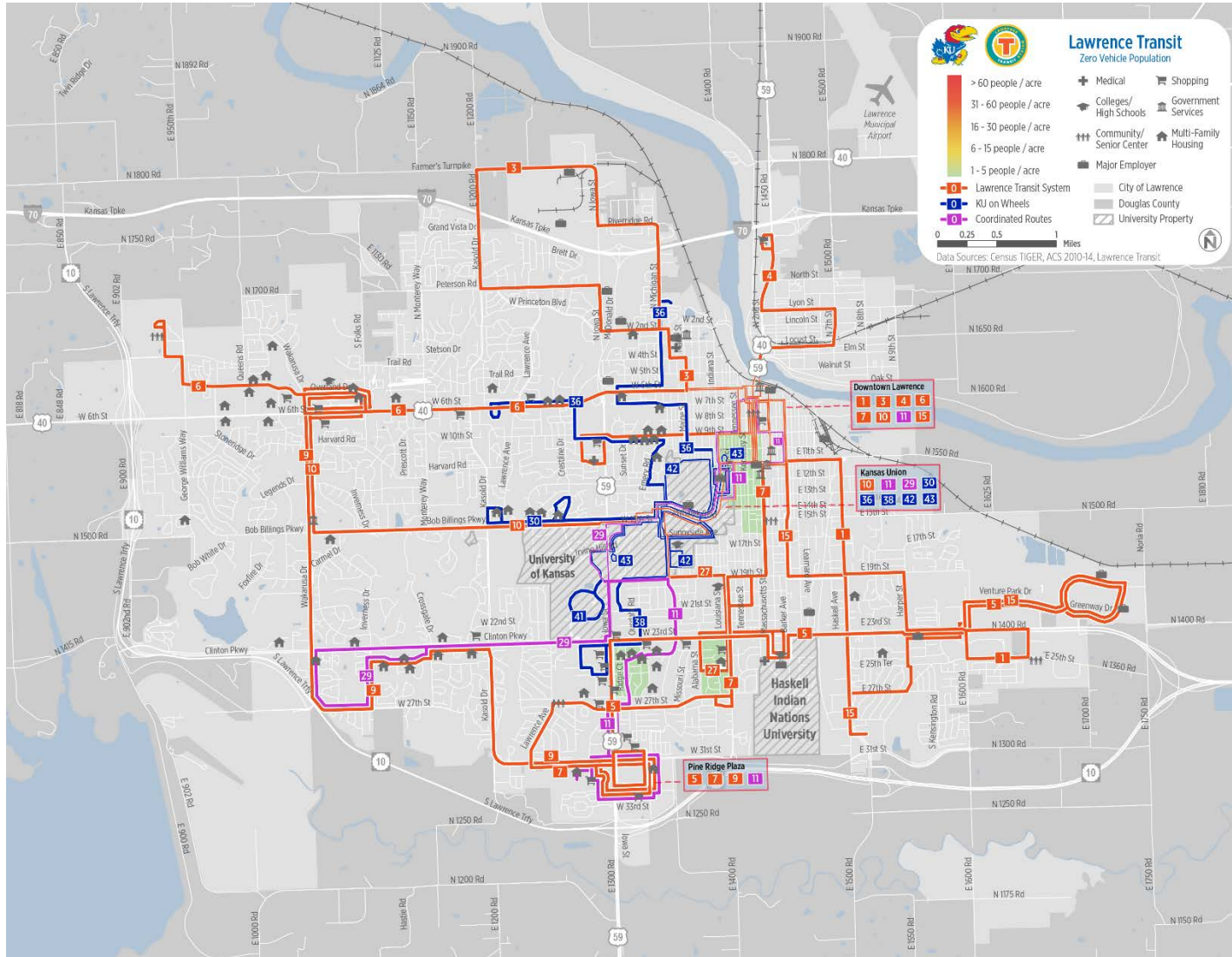

Transit Need Index

The Transit Need Index is a composite measure that aggregates the density of each high transit-need demographic group discussed above. Areas with higher Transit Need Index scores have a greater density of individuals who are more likely to use transit. Transit need does not necessarily equate to transit demand; rather, this analysis highlights areas of the community where high concentrations of people who typically rely on transit happen to live. Actual ridership is based on additional factors such as route structure, frequency, reliability, and accessibility.

Figure 2-11 shows the Transit Need Index scores for neighborhoods in Lawrence. Most areas with notable transit need populations are located within older established Lawrence neighborhoods surrounding downtown and KU campus. The highest transit need areas are primarily located near KU in the Oread neighborhood, Sunset Hills, and the neighborhood south of the University that contains numerous student apartment complexes. Nearly all neighborhoods with a high transit need population are currently served by Lawrence Transit and KUOW.

LAWRENCE TRANSIT COA | MARKET ANALYSIS

Lawrence-Douglas County MPO

Figure 2-11 | Transit Need Index Map

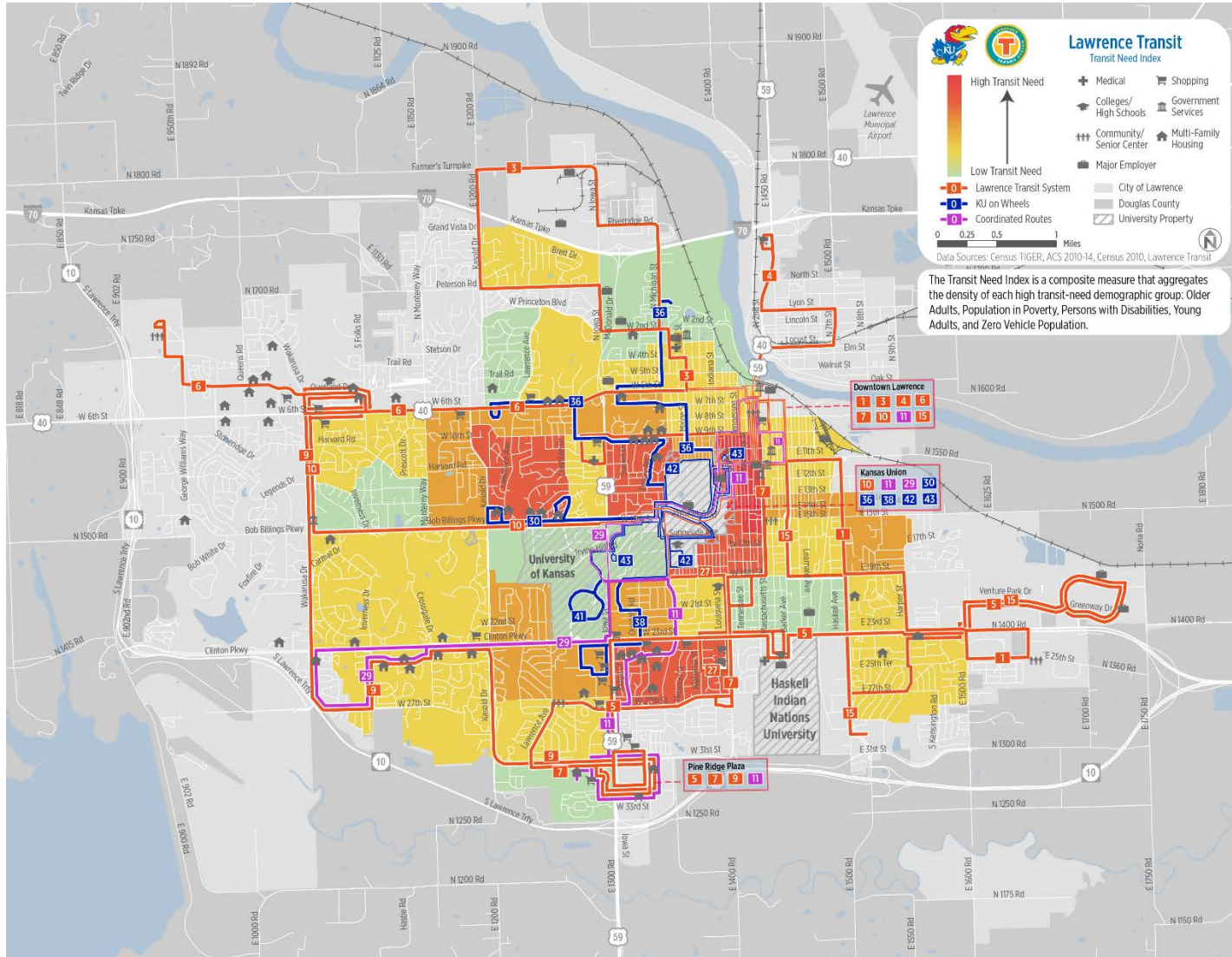

3 ANALYSIS OF EXISTING SYSTEM

Existing Lawrence Transit and KUOW services in Lawrence were evaluated individually and as a network. This analysis is presented in three parts:

- **Service Performance:** An overview of CS's service productivity.
- **Adherence to Guiding Principles:** An examination of whether existing transit services conform to common characteristics of high performing transit networks.
- **Route Profiles:** In-depth analyses of each Lawrence Transit and KUOW route. The profiles include route/service descriptions, service productivity data, and potential service improvement recommendations. Each route is evaluated based on alignment, operating characteristics, and markets served, as well as ridership, productivity, and on-time performance. Individual route profiles are included in Appendix A.

SERVICE PERFORMANCE

Fixed-Route Service

The Coordinated System (CS) of Lawrence Transit and KU on Wheels (KUOW) offers 18 fixed-route bus routes serving areas throughout the City of Lawrence (see Figure 3-1). All routes that primarily serve the City of Lawrence operate at a frequency of every 30, 40, or 60 minutes, and most run from approximately 6:00 AM to 8:00 PM, Monday through Saturday. KUOW service operates at a frequency of 30 minutes or better, Monday through Friday (when KU is in session), with more variable service spans (see Figure 3-2). Transit service is unavailable on Sundays in Lawrence. The CS's goal is to operate every fixed-route at a frequency of 30-minutes or better; however, a route must show demand for higher service frequency through adequate performance.

Lawrence Transit implemented several service improvements on August 1, 2016, after this study was underway. Thus, some of the analyses presented in this document reflect the previous service network. The primary service changes implemented on August 1st included:

- Route 1 began serving the Lawrence Community Shelter instead of Route 15.
- Route 3, a curb-to-curb "flex" service in northern Lawrence, was converted into fixed-route service and serves Lawrence Memorial Hospital instead of Route 6. The flex service, which had flexible routing in between designated time points, had low ridership and was not productive for the transit agency.
- Route 6 began serving Rock Chalk Park and Sports Pavilion Lawrence instead of Route 9.

Routes 5, 7, and 10 also went from 60-minute frequency to 30-minute frequency due to high ridership and demand for more transit service in the areas where these routes operate. Currently, only four CS routes operate less frequently than once every 30-minutes – Routes 4, 9, 15, and 27.

Figure 3-1 | 2016 Published Transit System Map

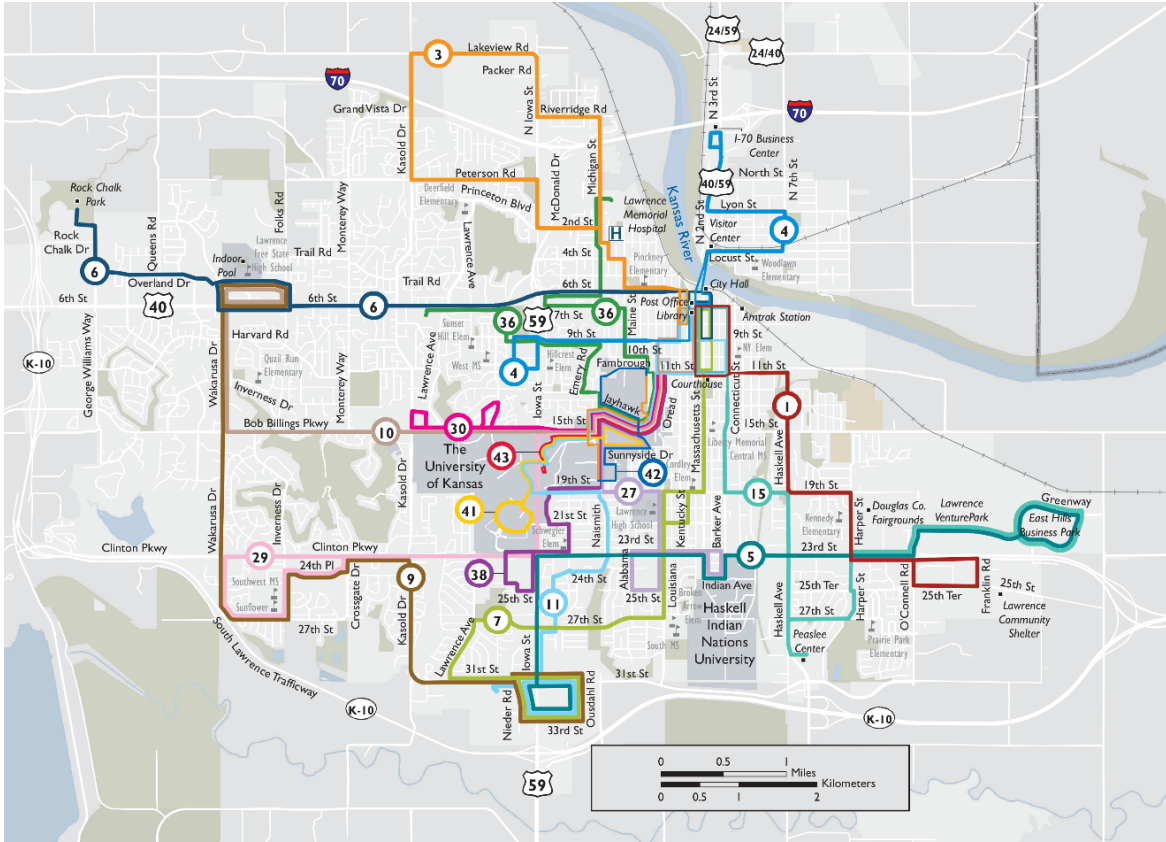

Figure 3-2 | Lawrence Transit and KU on Wheels Public Transit Service Characteristics

| Lawrence Transit (City) | | |
|--|---|-------------------|
| Service Name | Service Span | Service Frequency |
| Route 1 – Downtown to East Lawrence | Monday – Friday: 6:03 AM – 7:57 PM Saturday: 6:03 AM – 7:57 PM | 30 minutes |
| Route 3 – Downtown to Lakeview Road | Monday – Friday: 6:03 AM – 8:00 PM Saturday: 6:03 AM – 8:00 PM | 30 minutes |
| Route 4 – North Lawrence to 9 th & Iowa | Monday – Friday: 6:03 AM – 8:00 PM Saturday: 6:03 AM – 8:00 PM | 60 minutes |
| Route 5 – South Iowa to East Hills Business Park | Monday – Friday: 6:00 AM – 8:00 PM Saturday: 6:00 AM – 8:00 PM | 30 minutes |
| Route 6 – Downtown to 6 th & Wakarusa | Monday – Friday: 6:03 AM – 7:54 PM Saturday: 6:03 AM – 7:54 PM | 30 minutes |
| Route 7 – Downtown to South Iowa | Monday – Friday: 6:02 AM – 8:00 PM Saturday: 6:02 AM – 8:00 PM | 30 minutes |
| Route 9 – South Iowa to 6 th & Wakarusa | Monday – Friday: 6:02 AM – 7:57 PM Saturday: 6:02 AM – 7:57 PM | 60 minutes |

LAWRENCE TRANSIT COA | EXISTING SYSTEM
Lawrence-Douglas County MPO

| | | |
|---|---|------------|
| Route 10 – Downtown to 6 th & Wakarusa | Monday – Friday: 6:02 AM – 8:00 PM Saturday: 6:02 AM – 8:00 PM | 30 minutes |
| Route 15 – Downtown to the Peaslee Center | Monday – Friday: 6:00 AM – 7:56 PM Saturday: 6:00 AM – 7:56 PM | 60 minutes |
| Route 27 – KU to Haskell Indian Nations University | Monday – Friday (KU Fall/Spring): 7:05 AM – 6:22 PM Saturday: No service | 40 minutes |

KU on Wheels (University)*

| Service Name | Service Span | Service Frequency |
|--|---|--|
| Route 30 – Bob Billings & Kasold to KU | Monday – Friday: 7:10 AM – 5:57 PM Saturday: No service | 20 minutes |
| Route 36 – 6 th via Emery to KU | Monday – Friday: 7:05 AM – 6:34 PM Saturday: No service | 30 minutes |
| Route 38 – 25 th & Melrose to KU | Monday – Friday: 7:15 AM – 6:53 PM Saturday: No service | 20-30 minutes |
| Route 41 – Campus Circulator (Yellow) | Monday – Thursday (KU Fall/Spring): 6:30 AM – 10:30 PM Friday (KU Fall/Spring): 6:30 AM – 6:50 PM Monday – Friday (KU Summer): 6:30 AM – 6:30 PM Saturday: No service | Monday – Thursday (KU Fall/Spring): 8 – 30 minutes Friday (KU Fall/Spring): 8 – 30 minutes Monday – Friday (KU Summer): 30 minutes |
| Route 42 – Campus Circulator (Blue/Orange) | Monday – Thursday: 7:10 AM – 10:26 PM Friday: 7:10 AM – 6:56 PM Saturday: No service | Monday – Thursday: 15-30 minutes Friday: 15 minutes |
| Route 43 – Campus Circulator (Red) | Monday – Thursday: 7:20 AM – 10:30 PM Friday: 7:20 AM – 6:45 PM Saturday: No service | 6-9 minutes |
| SafeBus (students only) | Thursday – Saturday: 9:00 PM – 3:00 AM | 20-30 minutes |

*All routes operate only during the KU Fall/Spring Semesters except where noted.

Coordinated Routes (City and University)

| Service Name | Service Span | Service Frequency |
|---|--|--|
| Route 11 – South Iowa to KU to Downtown and Downtown to KU to South Iowa | Monday – Friday (KU Fall/Spring): 6:03 AM – 8:03 PM Monday – Friday (KU Summer), Saturday: 6:31 AM – 7:52 PM | Monday – Friday (KU Fall/Spring): 30 minutes Monday – Friday (KU Summer), Saturday: 30 – 60 minutes |
| Route 29 – 27 th & Wakarusa to KU | Monday – Friday (KU Fall/Spring): 7:00 AM – 6:22 PM Monday – Friday (KU Summer), Saturday: 7:20 AM – 6:22 PM | Monday – Friday (KU Fall/Spring): 20 minutes Monday – Friday (KU Summer), Saturday: 40 – 60 minutes |

| Demand-Response Services (City and University) | | |
|---|--|--|
| Service Name | Service Span | Service Frequency |
| T Lift (Lawrence Transit) – City of Lawrence, ADA paratransit | Monday – Saturday: 6:00 AM – 8:00 PM | Scheduled by 5 PM the day before the requested trip; 30-minute pickup window |
| Night Line (Lawrence Transit) – City of Lawrence, ADA paratransit and general public | Monday – Saturday: 8:00 PM – 6:00 AM | Scheduled in advance within regular business hours; 30-minute pickup window |
| JayLift (KU on Wheels) – Origin and/or destination on campus (students and employees only), ADA paratransit | Monday – Thursday (KU Fall/Spring): 6:30 AM – 10:30 PM Friday (KU Fall/Spring): 6:30 AM – 7:00 PM Monday – Friday (Summer): 6:30 AM – 6:30 PM | Scheduled 24-hours in advance |
| SafeRide (KU) – City of Lawrence (students only) | 7 days per week (KU Fall/Spring): 10:30 PM – 2:30 AM Thursday, Friday, and Saturday (KU Summer): 10:30 PM – 2:30 AM | Scheduled immediately |

Ridership and Productivity

The CS operates three different service schedules throughout the year depending on KU’s school calendar. When school is in session, the agency operates on a full schedule on weekdays, which are shown in yellow on the published service calendar (see Figure 3-3). Routes 11, 29, and 41 operate on “A” schedules. Route 27 and KU routes do not operate during the summer and school vacations, except for a reduced “B” schedule on Route 41. Routes 11 and 29 also operate on a “B” schedule on these days, which are shown in blue on the service calendar. On Saturdays and some holidays, shown in green on the service calendar, Route 27 and KU routes do not operate, and Routes 11 and 29 are again on a “B” schedule. The CS does not operate any service on Sundays and on six major holidays throughout the year.

An overview of service performance statistics for fixed-route bus services in Lawrence broken down by the three different types of service days is provided in Figure 3-4 below. An average of 19,281 riders board Lawrence Transit and KUOW service on a weekday while KU is in session, with 16.2 passengers per trip and 40.9 passengers per revenue hour. Ridership and productivity fall significantly on “Blue” and “Green” service days, primarily due to very limited KU service in operation and levels of service on Lawrence Transit

Figure 3-3 | 2016-2017 Service Calendar

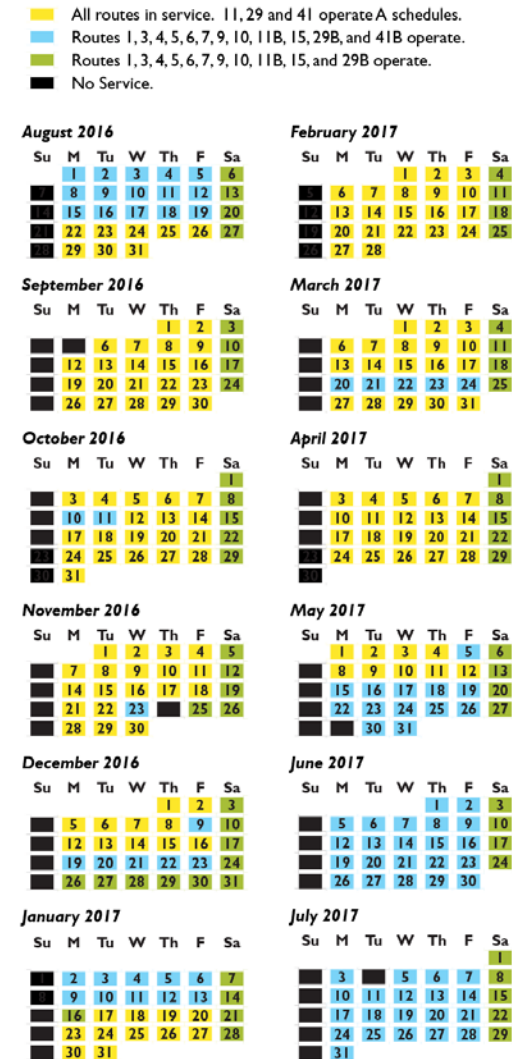

LAWRENCE TRANSIT COA | EXISTING SYSTEM
Lawrence-Douglas County MPO

routes remain similar to the service operated on “Yellow” days. The two coordinated routes, Routes 11 and 29, operate year-round but also rely heavily on student ridership. Route 11 ridership falls by over half on “Blue” service days and by approximately 70 percent on “Green” service days, as compared to “Yellow” service day ridership. Still, Route 11 remains the most heavily utilized route in the system when KU is not in session. Route 29 has very little ridership when KU is not in session.

Among Lawrence Transit routes, Routes 6, 7, and 10 perform the best overall across all service day types and metrics. Routes 7 and 10 recently went to 30-minute service from 60-minute service, which has induced ridership and improved performance. Route 43 is by a large margin the highest performing route on the KUOW system, but Route 41 also has high ridership and ridership per revenue hour. Route 42, the 30-series routes, and the coordinated routes generally fall between the Lawrence Transit and other KUOW routes in terms of ridership but maintain very good productivity.

LAWRENCE TRANSIT COA | FINAL REPORT
Lawrence-Douglas County MPO

Figure 3-4 | Daily Service Performance Statistics by Route

| Route | "Yellow" Service Day | | | "Blue" Service Day | | | "Green" Service Day | | |
|-----------------------------|----------------------|--------------------|----------------------------|--------------------|--------------------|----------------------------|---------------------|--------------------|----------------------------|
| | Ridership | Ridership per Trip | Ridership per Revenue Hour | Ridership | Ridership per Trip | Ridership per Revenue Hour | Ridership | Ridership per Trip | Ridership per Revenue Hour |
| 1 | 229 | 4.1 | 8.3 | 201 | 3.6 | 7.3 | 146 | 2.6 | 5.3 |
| 3 | 124 | 4.4 | 8.9 | 112 | 4.0 | 8.0 | 61 | 2.2 | 4.4 |
| 4 | 138 | 4.9 | 9.9 | 160 | 5.7 | 11.5 | 111 | 4.0 | 7.9 |
| 5 | 190 | 3.4 | 6.8 | 165 | 2.9 | 5.9 | 130 | 2.3 | 4.6 |
| 6 | 368 | 6.8 | 13.8 | 320 | 5.9 | 11.9 | 257 | 4.8 | 9.6 |
| 7 | 412 | 7.4 | 14.8 | 394 | 7.0 | 14.1 | 375 | 6.7 | 13.4 |
| 9 | 99 | 3.6 | 7.1 | 83 | 3.0 | 6.0 | 78 | 2.8 | 5.6 |
| 10 | 699 | 12.5 | 25.0 | 333 | 5.9 | 11.9 | 201 | 3.6 | 7.2 |
| 11 | 1,626 | 24.6 | 34.9 | 740 | 15.8 | 21.2 | 485 | 10.3 | 18.5 |
| 15 | 78 | 2.8 | 5.6 | 89 | 3.2 | 6.4 | 42 | 1.5 | 3.0 |
| 27 | 205 | 6.0 | 18.1 | - | - | - | - | - | - |
| 29 | 1,264 | 19.2 | 38.2 | 78 | 2.4 | 7.0 | 36 | 1.1 | 3.2 |
| 30 | 1,381 | 21.6 | 66.1 | - | - | - | - | - | - |
| 36 | 1,047 | 23.3 | 31.6 | - | - | - | - | - | - |
| 38 | 1,002 | 19.3 | 46.2 | - | - | - | - | - | - |
| 41 | 2,536 | 14.6 | 85.8 | 142 | 3.0 | 12.7 | - | - | - |
| 42 | 1,297 | 12.5 | 51.8 | - | - | - | - | - | - |
| 43 | 6,584 | 34.3 | 118.2 | - | - | - | - | - | - |
| System Total/Average | 19,281 | 16.2 | 40.9 | 2,818 | 5.5 | 11.2 | 1,920 | 4.1 | 8.3 |

Demand-Response Service

Lawrence Transit and KUOW operate three demand-response services, all contracted to MV Transportation via a turnkey contract:

- **T Lift:** Operated by Lawrence Transit, T Lift provides door-to-door service in the City of Lawrence to riders who cannot use fixed-route service because of a disability (ADA Complementary Paratransit). Service operates Monday through Saturday from 6:00 AM to 8:00 PM; trips must be scheduled by 5:00 PM the day before the scheduled trip, or as early as five days beforehand. The vehicle may arrive up to 15 minutes before or after the scheduled pick-up time.
- **Night Line:** Operated by Lawrence Transit within the City of Lawrence, Night Line provides curb-to-curb service for the general public and door-to-door service for T Lift eligible riders. Service operates Monday through Saturday from 8:00 PM to 6:00 AM (service operates until midnight on Saturdays and begins again at midnight on Monday morning), with a designated 30-minute pick-up window. Reservations can be scheduled up to five days in advance and up to 5:00 PM the day before the scheduled trip.
- **JayLift:** Operated by KUOW, JayLift provides curb-to-curb service for KU students and employees with disabilities. Service operates Monday through Thursday from 6:30 AM to 10:30 PM and from 6:30 AM to 7:00 PM on Fridays. Trips must be scheduled 24-hours in advance and can be placed as early as seven days in advance; no pick-up windows are clearly defined. JayLift is free to use but service is limited to on-campus destinations and off-campus housing.

All three services allow same-day trip reservations on a space-available basis only. MV Transportation, the CS's contractor, employs approximately 35 staff members to operate paratransit services in Lawrence, including call center staff (managers, reservationists, and schedulers/dispatchers), drivers, and road supervisors dedicated to both fixed-route and paratransit. Real-time scheduling is done on Trapeze (for T Lift and Night Line) to give riders their confirmed scheduled pick-up time and to manage trip time negotiations. For JayLift, requests are manually booked and immediately scheduled using a Google spreadsheet during the call. Twenty-four accessible vehicles (23 Ford E450s and one Ford E350) are used to operate Lawrence's coordinated paratransit services.

In addition to the services described above, KU students can also request a pick-up from SafeRide, a KU Student Senate-funded program administered by the SafeRide Subcommittee of the Transit Commission. SafeRide provides late-night on-demand sedan service for KU students traveling home to a residence within the city limits of Lawrence. Students are directed to SafeBus stops when that service is available and can accommodate the trip request. SafeRide is primarily a public safety service and operates more like a taxi service than a transit service.

Reservations and Scheduling

Most reservations for T Lift, Night Line, and JayLift are made by phone. However, some large agencies like Cottonwood, Inc. schedule some trips by fax or email. Reservationists work with callers to schedule a pick-up time (suggested 45 minutes before the needed drop-off time on T Lift and Night Line, and 15-30 minutes before drop-off on JayLift). Trip requests made outside of regular operating hours are left on an answering machine and scheduled the next day of operation. Riders must be ready during the +/- 15-minute pick-up window and cancel their trip at

least an hour before the scheduled pick-up time. Vehicle arrivals outside the 30-minute window are late trips.

T Lift and Night Line schedulers use Trapeze's PASS software to schedule trips, primarily via single insertions for each request and relying on the program's suggestions to narrow down possible assignments for that trip. Very little scheduling is accomplished through PASS's batch scheduling capabilities. When interviewed, schedulers trusted their own sense of scheduling more than PASS and felt they could create more realistic and productive schedules within the same amount of time than it would take to fix the batch scheduling solutions. Ultimately, the schedulers are equally uncomfortable with the trip-to-run assignments and travel times suggested by PASS.

Dispatching and Same-Day Issues

Dispatchers at the CS are proactive, looking ahead to solve problems before they become real-time problems. *Where's my ride?* calls are handled by the reservation agents who attempt to respond to the caller if the call is placed after the end of the pick-up window. This typically involves checking the dispatch window, with time points noted by the dispatcher. The reservationist may also transfer the caller to a dispatcher if radio contact with the driver is needed. If customer *Where's my ride?* calls are placed prematurely, the reservationist politely tells the caller to call back at the end of the pick-up window if the vehicle has still not arrived.

The vehicle will wait up to 5-minutes after arrival at the designated pick-up site, and a rider who does not board within that 5 minutes is considered a no-show. In the case of T Lift customers and ADA paratransit customers on Night Line, drivers are instructed to provide door-to-door service and so will ring the doorbell or knock on the outside door before calling in a no-show to the dispatcher. Dispatchers at the CS do not try to reach the customer by phone to inform them that their ride is waiting, which is different than most other ADA paratransit services in the U.S.

Ridership and Productivity

The 2015 ridership on T Lift totaled 63,406 trips, up from 61,444 trips in 2014, a 3.2 percent increase (see Figure 3-5). As shown in Figure 3-6, the most dramatic increase during the period from 2007 to 2015 was between 2012 and 2013 when ridership increased by 12.7 percent increase. Over the long-term, however, ridership on T Lift has remained fairly stable, increasing only 10.3 percent over the period from 2007 to 2015, or an average of about 1.3 percent per year. Night Line ridership has only been captured for 2014 and 2015, increasing from 14,462 to 15,958 trips, an increase of 10.3 percent.

T Lift's revenue hours increased 5.4 percent from 26,933 in 2014 to 28,396 in 2015, during which ridership increased by 3.2 percent. Consequently, ridership per revenue hour decreased from 2.28 to 2.23. Over the period from 2007 through 2015, ridership per revenue hour on T Lift has ranged between 2.06 and 2.41. From 2014 to 2015 on Night Line, the number of revenue hours remained fairly level, and with its ridership increasing by 10.3 percent, Night Line's productivity also increased by about 10.6 percent (from 1.60 to 1.77 trips per hour).

Nelson\Nygaard spent a day on-site interviewing managers and front-line staff of the demand-response services in Lawrence. The information here summarizes those notes, but for a full copy, which informed the recommendations presented later in this document, please see Appendix B.

Figure 3-5 | Service and Cost Statistics on T Lift, Night Line, and JayLift – 2014-2015

| | 2014 | | | 2015 | | |
|----------------------------|---------|------------|---------|---------|------------|---------|
| | T Lift | Night Line | JayLift | T Lift | Night Line | JayLift |
| Ridership | 61,444 | 14,462 | N/A | 63,406 | 15,958 | 3,382 |
| Revenue Hours | 26,933 | 9,041 | N/A | 28,396 | 9,023 | 2,855 |
| Cost per Trip | \$27.52 | \$40.19 | N/A | \$25.44 | \$32.61 | N/A |
| Cost per Revenue Hour | \$62.77 | \$64.28 | N/A | \$56.81 | \$57.67 | N/A |
| Ridership per Revenue Hour | 2.28 | 1.60 | N/A | 2.23 | 1.77 | 1.18 |

Figure 3-6 | Ridership on T Lift and Night Line Service – 2007-2015

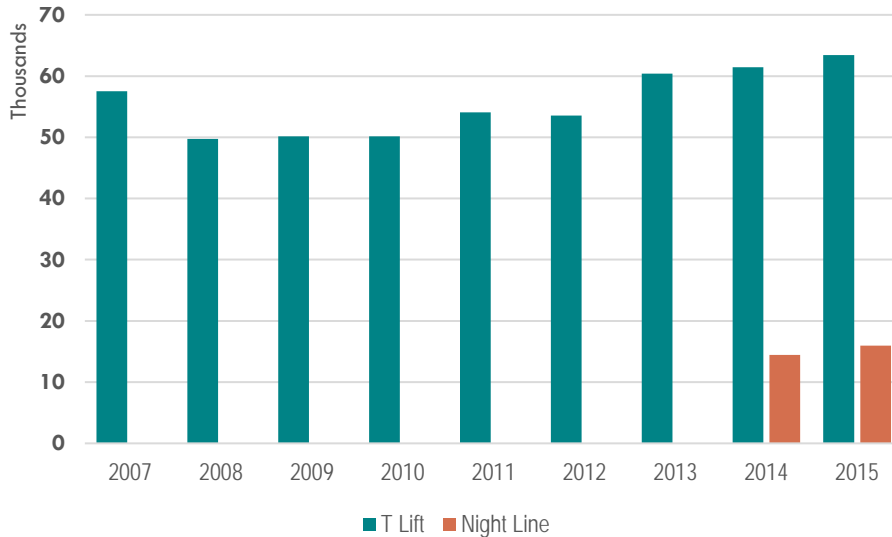

Passenger Facilities

Bus stops in the City of Lawrence are designated with blue and white bus stop signs (see Figure 3-7). Shelters, benches, system maps, and other amenities are available at some stops. However, the presence of these passenger amenities do not always indicate a high-ridership stop. In many cases, the locations for passenger amenities were chosen around the time service began in 2000 and before clear ridership patterns developed. Some transit riders in the eastern part of the city have recently started a grassroots effort to place chairs, benches, and other personal amenities at their stops, which has created concern for the public image of transit in Lawrence and liability issues with amenities being placed in the public right-of-way.

Figure 3-7 | Bus Stop Sign, Lawrence, KS



The CS has two primary transit hubs. Most KUOW routes, as well as several Lawrence Transit routes, serve the Kansas Union. The Union serves as a gateway to campus and transfer location between various CS routes. Most Lawrence Transit routes serve a stop at W 7th and Vermont Street. This stop is conveniently located near many key downtown destinations including the main post office, Lawrence Public Library, and Lawrence City Hall. The downtown hub also facilitates transfers for passengers traveling from one part of the city to another. However, the location of this hub is considered temporary, having moved from E 9th and New Hampshire Streets in the summer of 2013. It remains a long-term goal of Lawrence Transit and KUOW to eventually build a centralized transit hub to provide both systems with a safe and convenient operating environment.

Multimodal Connections & Amenities

The CS issued an Amenities Guidelines and Policies report in July 2015.⁴ The report outlines specific purposes, thresholds, location factors, and design factors for bus passenger amenities, including bus stop signs, bus stop pads, benches, shelters, information displays, landscaping, shelter lighting, leaning rails, trash receptacles, bollards, and bike racks. Presently, all buses in Lawrence are equipped with bike racks that can hold up to two bikes. Bus stop signs and route designations are required for all stops; benches, shelters, information displays, and trash receptacles are required for stops featuring more than 25 daily boardings; lighting, bicycle racks, landscaping, leaning rails, and bollards are required for stops featuring more than 50 daily boardings. A map of the stops with 25-49 and 50 plus daily boardings is shown in Figure 3-8. A majority of the stops are on KU's campus or along Clinton Parkway, Bob Billings Parkway, and Iowa Street.

The Multimodal Planning Studies identified transportation improvements for all types of users that can be implemented over five to ten years to create a more multimodal region.⁵ In particular, the 2013 Fixed Route Transit and Pedestrian Accessibility Study focused on transit users,⁶ who are nearly always also pedestrians for at least one segment of their trip. The report identified obstacles current or potential users face in accessing transit, specific issues with streets and sidewalks, locations for pedestrian improvements, and locations for potential bus turnouts. Based on a synthesis of the data collected, the report authors identified four major corridors, which were representative of the various transit-pedestrian accessibility issues that are frequently observed throughout the Lawrence area. These corridors included 6th Street, Naismith Drive, 19th Street, and 23rd Street. Along with specific recommendations for each of these four corridors, the report also provided recommendations for spot improvements and potential policy updates to provide better long-term support to pedestrians.

A 2016 inventory of bicycle parking in downtown Lawrence,⁷ an update to an earlier 2010 report, discussed the existing condition of bicycle amenities in Lawrence, as well as identified best practices and an evaluation of how well Lawrence meets those best practices. The report identified 406 bicycle parking spaces, an increase from 304 in 2011, with most of these being of a type that the Association of Pedestrian and Bicycle Professionals (APBP) recommends. A study of the capacity and demand for bicycle parking revealed that while capacity is greater than or meeting demand, the presence of bicycles illegally locked to trees and other posts or signs means that the capacity might not always be well-matched with the location of the demand. The report details six recommendations that focus on creating design standards for bicycle amenities, updating development codes and other city policies, educating the public about parking options, and finding a balance between capacity and placement of bicycle parking in downtown Lawrence.

LAWRENCE TRANSIT COA | EXISTING SYSTEM
Lawrence-Douglas County MPO

Figure 3-8 | Stops Requiring Amenities – 25-49 and 50+ Daily Boardings

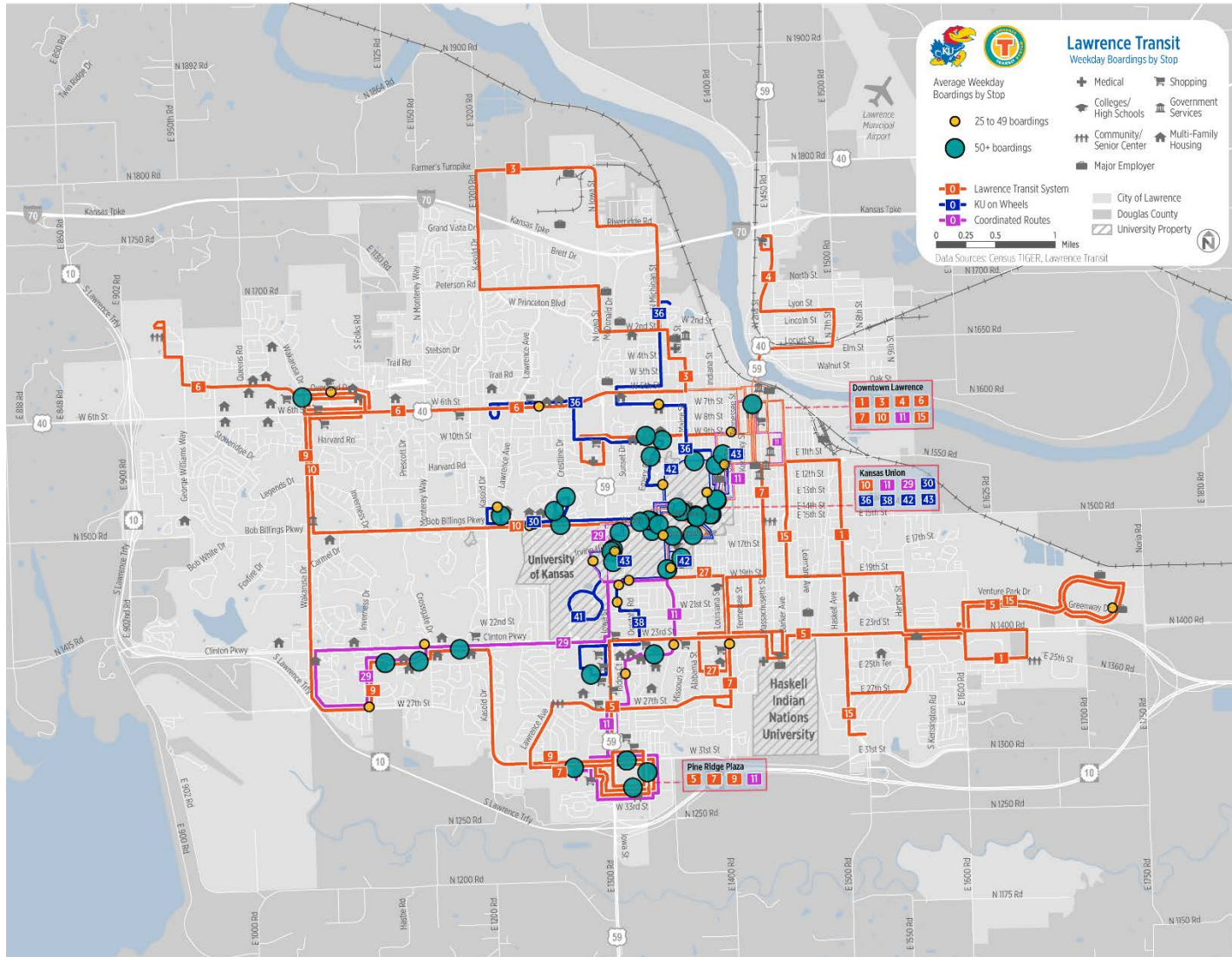

PUBLIC FEEDBACK

In May of 2016, the study team conducted the first round of public meetings to inform the public about the study, share initial results, learn about the strengths and challenges of the existing system, and help the team find opportunities or focus-points for the remainder of the study. The meetings were advertised through a press release from the MPO, on-board the buses, and on lawrencetransitstudy.com. The website also included meeting materials for download. We conducted drop-in sessions with front line staff of the transit service, a drop-in session at KU, and a public open-house style meeting. The study team brought display boards to each of these locations with a heat map of the preliminary ridership data and maps of the market analysis results. At the same time, an online survey that corresponded to the on-board survey but also included a separate survey for non-riders was available to provide feedback for those unable to attend a public engagement session in person. The full results of that survey are included in Appendix C. A summary of the comments from the public at the outreach events follows.

Drop-in Sessions with Front Line Staff (May 10, 2016)

Front line staff including drivers, dispatchers, and field supervisors are the face of any transit service. Passengers interact with these staff more than anyone else in the agency, so they often have a good understanding of the public's likes, dislikes, and wishes. For the drop-in session, we set up the outreach materials in the break room and tried to be there during a shift change or when drivers had time to talk with the team. However, the front line staff could choose whether or not to talk with project staff. The most frequent comments expressed at this event are summarized below.

- West 21st Street and Stewart Avenue would be a great place for a transit hub
- More service will probably be needed to Venture Park as it gets built out
- Nieder Road has two stops very close together; should be consolidated into a single stop
- Route 11 needs a stop closer to the United Way
- Routes 1 and 9 do not have enough time for recovery; Route 1 needs another bus
- Route 5 riders do not have good service to downtown because transfers to Route 1 are not well coordinated, and transfers to Route 15 are too infrequent
- Route 9 is not well coordinated with Routes 6 and 10
- All routes need later service and Sunday service
- All routes should operate every 30 minutes
- North Michigan should have fixed-route service
 - *Route 3 was on-demand at the time of our public outreach in May*
- Route 41 should serve the Rec Center after 6:00 PM
- Need more communication to riders; people hear something, but drivers do not know
- Wakarusa – round-about at Legends Drive is hard to maneuver
- Need better coordination with the JO (the JO provides public transportation in Johnson County, which is east of Douglas County, and to downtown Kansas City, MO; the agency operates the K-10 Connector between Lawrence and Overland Park in Kansas)

Drop-in Session and Public Meeting (May 11, 2016)

The drop-in session and open-house style public meeting allowed the study team to interact directly with students and Lawrence residents, often one-on-one. Comments and statements received during this session are summarized as follows:

- Strengths
 - Great drivers
 - Good customer service
 - Coverage is good
 - Night Line is great
- Challenges
 - Buses run empty on weekends
 - Have to plan ahead to not make a transfer
 - New drivers refuse to call ahead
 - Southwest corner of Bob Billings Parkway & Kasold Drive is dangerous
 - North Lawrence – not able to access the bus, pedestrian environment is not good
- Key priorities
 - Central transfer point for both systems
 - Amenities improved – image, East Lawrence
- Comments on specific routes
 - Route 10 needs 30-minute service
 - *As of August 1, 2016, Route 10 operates every 30 minutes*
 - Route 10 runs late
 - Route 9 connections need to be cleaned up
 - Coordination of Amtrak and Night Line should be improved
- Service issues
 - Hours of operation – time between regular service and Night Line service can be hard
 - High barrier to riding even under existing conditions
 - Make system more appealing to casual riders or non-users
 - Ease of understanding should be improved
 - Fares – hard to carry cash
- Public information and passenger environment
 - Route numbers on signs
 - People lingering around bus stop who harass others
- Areas that need more or better service
 - Lawrence Memorial Hospital (LMH) South – southwest corner of Kasold Drive and Clinton Parkway
 - Prompt Care – southwest corner of Kasold Drive and Clinton Parkway
 - Peaslee Center
 - DMV in North Lawrence

The comments heard from the front line staff and public were used when making recommendations in the individual route profiles (found in Appendix A) and in developing the two scenarios that were presented to the public for feedback in October 2016.

ADHERENCE TO GUIDING PRINCIPLES

Transit services are most successful when they are simple, easy to use, and intuitive to understand. While each operating environment is unique, adherence to the general guiding principles described below has proven to improve the quality of transit services and reduce the barriers to access for prospective riders.

Service Should Operate at Regular Intervals

In general, people can easily remember repeating patterns but have difficulty remembering irregular sequences. Transit riders may find transit routes that operate at different times each hour cumbersome to use. Irregular schedules increase the likelihood a rider will miss a trip or a transfer, thus decreasing the utility of the service. In many cases, operating a service at regular intervals provides a better transit experience for riders, even if doing so results in slightly decreased service frequency.

Ideally, transit routes that operate less frequently than every 15-minutes should utilize clockface scheduling. With a clockface schedule, each bus arrives at the same time or times each hour. For example, a bus route with 20-minute frequency might arrive at :00, :20, and :40 each hour throughout a service period.

Clockface scheduling significantly enhances transit service usability, especially in systems with less frequent service. Passengers can easily remember when their bus will come without having to rely on a paper or online schedule. Regular clockface schedules can also help simplify transfers between routes. Even if two routes do not arrive at a stop at the same time, clockface frequencies will ensure that wait-times between buses are consistent and predictable.

All existing Lawrence Transit routes operate at regular clockface intervals throughout weekday and Saturday service (see Figure 3-9). Most routes begin between two and five minutes after 6:00 or 6:30 AM and continue with that schedule throughout the day. The 30-series KUOW routes, as well as KUOW Route 42, also operate on regular clockface intervals, while KUOW Routes 41 and 43 operate at such high frequency that clockface headways are unimportant.

Figure 3-9 | Examples of Regular Service Intervals

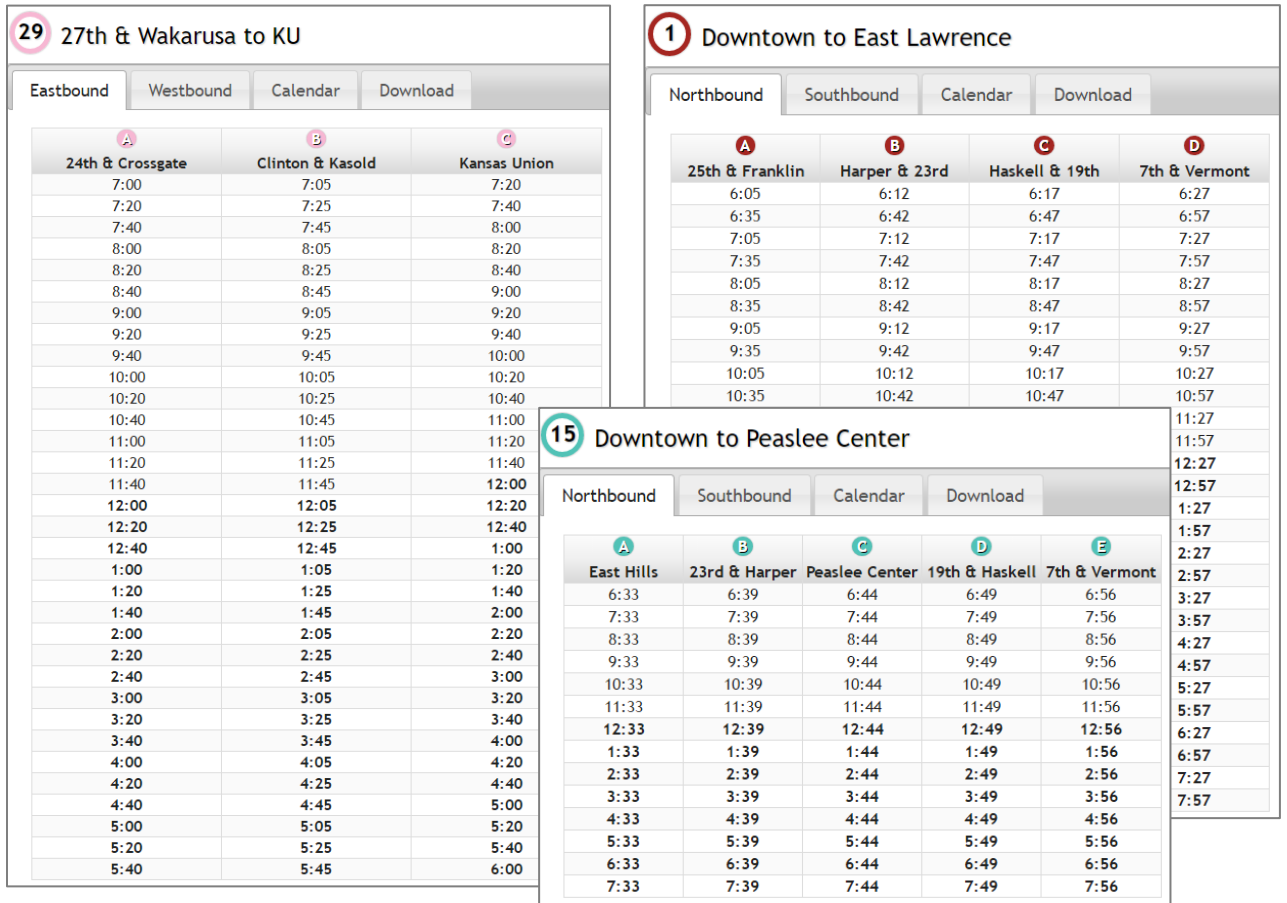

Routes Should Operate Along a Direct Path

The fewer directional changes a route makes, the easier it is to understand. Circuitous alignments are disorienting and difficult to remember. Some deviations from the most direct path of travel are necessary and justifiable given that major destinations are sometimes located off of major roadways. However, frequent deviations from the most direct path of travel will increase travel times for the majority of passengers and should be avoided unless there is a strong justification.

Many Lawrence Transit and KUOW routes adhere to this principle. Some, like Route 6, operate along very direct alignments (see Figure 3-10). Others, like Route 1, have a number of turns along the route but still give riders the sense of continuous forward progress (see Figure 3-11).

However, other routes make substantial deviations or directional changes with little benefit in terms of ridership gain. For example, Route 15 operates between downtown Lawrence and the East Hills Business Park via the Peaslee Workforce Center (see Figure 3-12). While the Peaslee Center generates very little ridership, downtown Lawrence and the East Hills Business Park are both major trip generators. Consequently, a majority of Route 15 passengers are forced to ride out of direction to reach their intended destination. The deviation of Route 15 to the Peaslee Center likely limits the route's appeal for current and prospective riders.

Figure 3-10 | Example Direct Alignment (Route 6)



Figure 3-11 | Example of Continuous Forward Progress (Route 1)

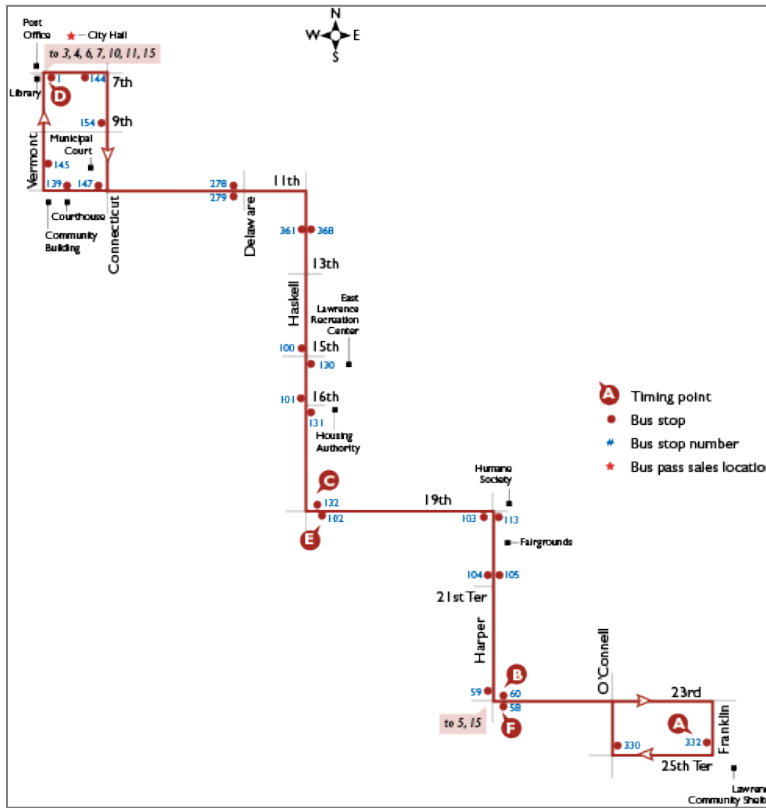
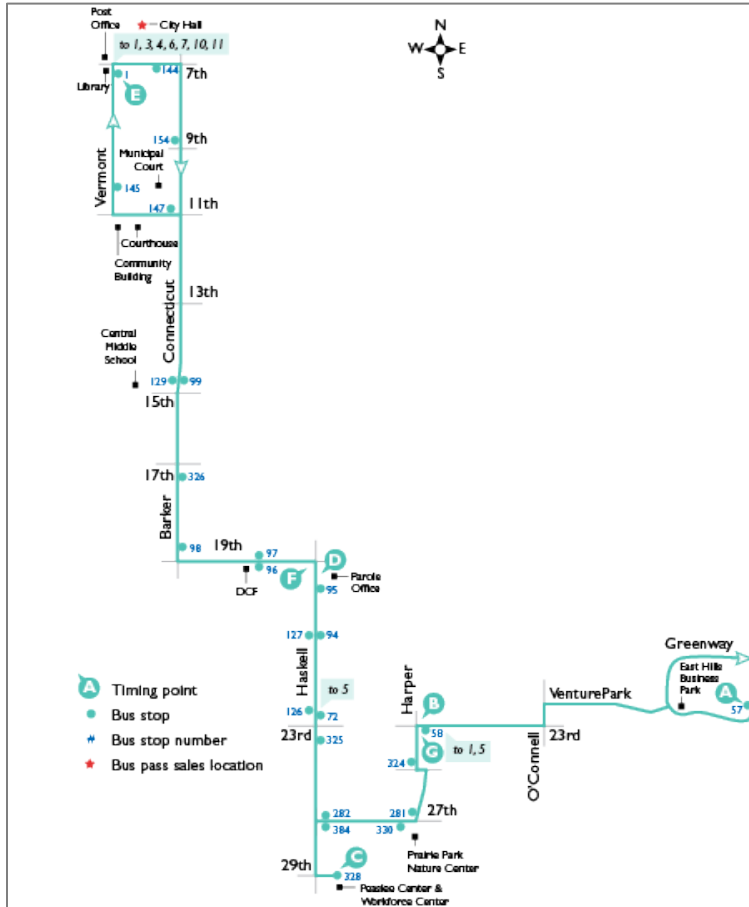

Figure 3-12 | Example of Circuitous Route Alignment (Route 15)



Routes Should be Symmetrical

Routes should operate along the same alignment in both directions to make it easy for riders to know how to get back to where they came from. Providing service on different streets depending on direction can make it difficult for passengers to find the bus stop for their return trip. Splitting service between two streets is sometimes unavoidable due to one-way traffic patterns, but to the extent possible, bus stops for service in opposite directions should be across from one another on opposite sides of the same street.

Large one-way loops can also frustrate riders by forcing out-of-direction travel on either the outbound or return trip. In most circumstances, transit riders prefer bi-directional services that they have to walk somewhat further to access over a close but one-way route.

Most Lawrence Transit and KUOW routes do provide symmetrical service along much of their alignment. Nearly every stop on Route 10, for example, is paired with a stop on the opposite side of the street, making return trips simple (see Figure 3-13). Some one-way loops are unavoidable, as buses must be turned around at the end of the line. However, Lawrence Transit Route 3 (see Figure 3-14) is an example of a very large one-way loop that forces significant out-of-direction travel on either the outbound or return trip. A passenger boarding the route on N. Iowa Street, south of Peterson must ride north to Lakeview Road before beginning their inbound trip to downtown Lawrence.

In downtown Lawrence, several routes operate northbound on Vermont Street and southbound on Connecticut Street, a separation of four blocks. This is due to ongoing construction and service disruptions in the New Hampshire corridor. Ideally, if a route cannot operate on the same street in both directions, the two directions of service should be separated by one or two blocks.

Figure 3-13 | Example of a Symmetrical Route Alignment (Route 10)

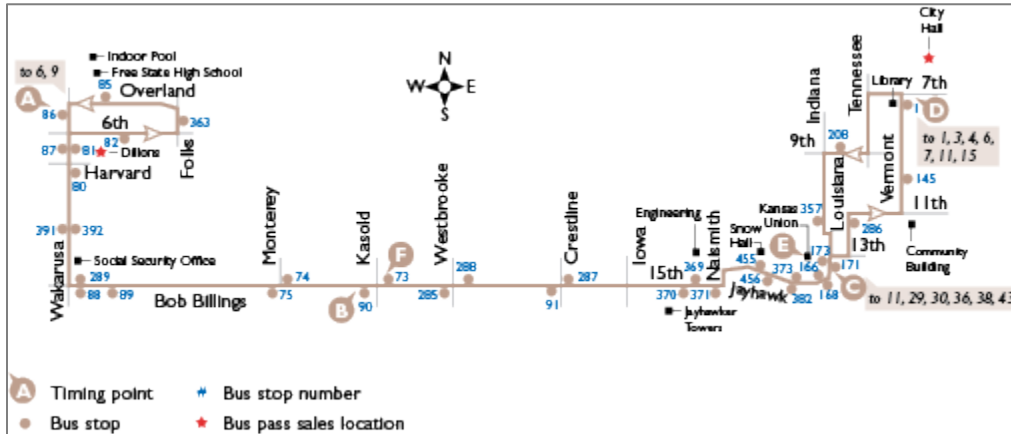
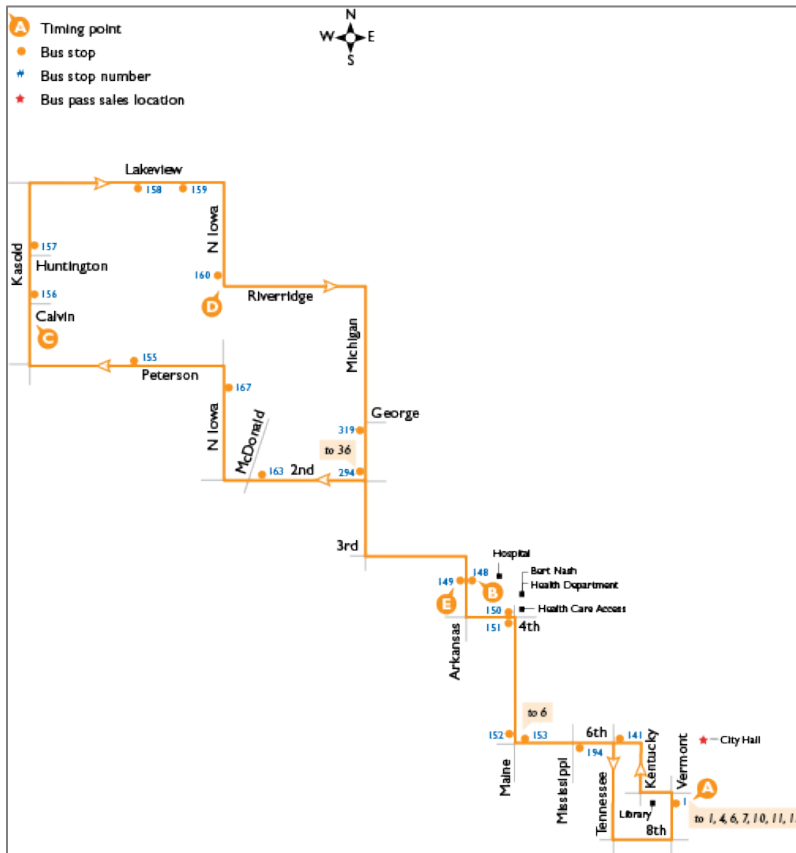

Figure 3-14 | Example of an Asymmetrical Route Alignment (Route 3)



Routes Should Serve Well Defined Markets

While the mission of KUOW routes is clearly to connect areas of Lawrence with high concentrations of student housing to the KU campus, Lawrence Transit is intended to provide general mobility to Lawrence residents. As a network, Lawrence Transit provides riders with access to a wide range of destinations throughout the city. However, a transit network is strongest when each individual route includes strong anchors and serves a mix of origins and destinations (other than transfer hubs). Some Lawrence Transit routes do this well. For example, Route 11 serves multiple apartment complexes that act as origins for transit trips; three strong anchors in downtown Lawrence, KU, and Walmart; and numerous additional destinations such as Dillons Supermarket and the United Way. However, other routes, such as Route 1, serve multiple apartment complexes, but provide no direct access to grocery stores. Requiring passengers to transfer with grocery bags is a significant burden for many existing and prospective riders, and thus reduces the appeal of the service.

Service Should Be Well Coordinated

At major transfer locations, schedules should be coordinated to the greatest extent possible to minimize connection times between services. In general, there are two approaches to coordinating transit service:

- The first approach is to establish clockface service frequencies on all routes. This ensures a certain predictability for transfers as passengers know when to expect each route regardless of the hour of the day. Clockface schedules can also facilitate pulsing, which is when several routes are designed to arrive at a particular transfer location at the same time. Pulsing is usually used when a transit network has a single primary hub.
- The second approach to coordinating transit service is simply to maximize service frequencies on all routes. High frequencies reduce the need to pulse services at a particular location because passengers who miss a connection anywhere in the system can catch the next bus in a relatively short time. If service frequencies cannot be increased at all times due to budget constraints, it is best to increase frequencies during peak-periods when the majority of transfers between services occur.

Lawrence Transit and KUOW use a combination of the two approaches, with most buses operating at a frequency of at least every 30-minute from one of two main transfer hubs (7th & Vermont and the KU Union). Routes are also pulsed when possible, especially those that operate at lower frequency.

4 DEVELOPMENT OF SERVICE SCENARIOS

Lawrence’s existing transit network has seen strong ridership growth and community support since its inception in December 2000. It is, without question, a system with many positive features worth preserving. However, like any transit system, Lawrence Transit and KUOW also have room for improvement. For example, the market analysis described in Chapter 2 showed areas of Lawrence with existing fixed-route transit service that lack the density to effectively support this type of service. The service analysis discussed in Chapter 3, including individual route profiles, validated this conclusion by showing generally low ridership in areas with low population and employment density.

Lawrence Transit operates under the directive of City leadership to provide a “coverage” service, meaning that service should have a broad geographic coverage to ensure that it is available to most residents should they choose to use it. However, by committing resources to serve areas of the city with low transit potential, Lawrence Transit’s ability to provide more robust service in areas that have the strongest potential to support it is limited.

The aim of this study was to point out the strengths and weaknesses of the existing system in terms of ridership and productivity. The figure and descriptions below highlight some of the key areas for service improvement based on the findings of the market analysis, service analyses, and adherence to guiding principles presented in Chapter 3. These areas for improvement include poor performing routes or route segments that could be considered for elimination. Ultimately, the decision to eliminate some fixed-route service coverage will require political consensus among City leadership to allow Lawrence Transit to consider productivity as well as coverage in their service design decisions.

LAWRENCE TRANSIT COA | FINAL REPORT
Lawrence-Douglas County MPO

Figure 4-1 | Identified Service Improvement Opportunities

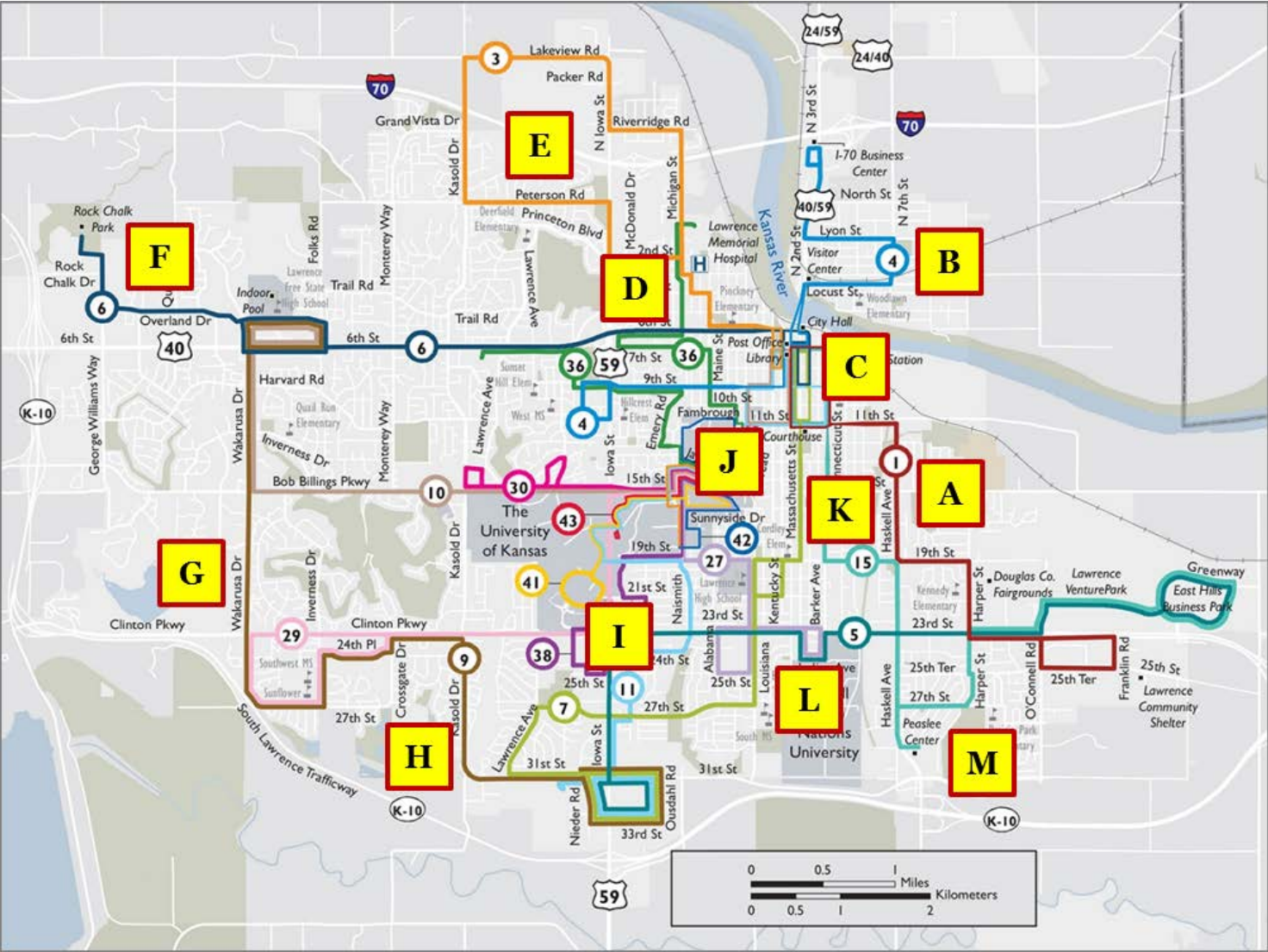

LAWRENCE TRANSIT COA | SERVICE SCENARIOS

Lawrence-Douglas County MPO

- A. **No direct access to groceries** – Haskell Avenue has a high concentration of apartment complexes, both north and south of 19th Street, but neither Route 1 nor Route 15 offer direct access to any grocery stores.
- B. **Limited access to grocery and retail destinations** – North Lawrence is sometimes referred to as a food desert due to the lack of local grocery stores or retail destinations. Route 4 does provide a one-seat ride between North Lawrence and The Merc Co-op, but the Merc's prices and selection do not necessarily appeal to the majority of North Lawrence transit riders.
- C. **Complex service design** – Routes serving downtown Lawrence follow a number of different alignments north of 11th Street. Northbound and southbound service on Routes 1 and 15 are separated by four blocks, making it somewhat difficult for riders to find the stop for their return trip.
- D. **Low ridership** – While Route 36 performs well overall, there is very little ridership along Michigan Street, north of 6th Street. This is likely a reflection of both a weak market for KU-focused service north of 6th Street, and the perceived indirectness of service from Michigan Street to KU.
- E. **Large one-way loop** – Route 3 provides coverage to a large area of northern Lawrence, but service north of Lawrence Memorial Hospital operates in the clockwise direction only. This design forces significant out of direction travel for trips beginning or ending within the terminal loop.
- F. **Emerging transit market** – The area around Rock Chalk Park is experiencing significant multi-family housing development supported by pedestrian and transit-friendly features such as sidewalks and a grid-style street network. These characteristics will likely lead to growing transit ridership in the area.
- G. **Low ridership** – Wakarusa Drive, between Clinton Parkway and Bob Billings Parkway, generates very little ridership and has low transit potential based on adjacent density and land-use.
- H. **Low ridership** – Kasold Drive, south of Clinton Parkway, generates very little ridership and has low transit potential based on adjacent density and land-use.
- I. **Service redundancy** – The Clinton Parkway/Iowa Street intersection is served directly or in close proximity by several routes operating along similar but slightly different alignments. Consolidating some of the service could improve system productivity.
- J. **Complex service design** – Route 42 is the most complex of the KUOW routes and includes multiple segments of one-way service. Consequently, it has the lowest ridership per trip among KUOW routes.
- K. **Low ridership** – Connecticut Street, south of 11th Street, generates little ridership due, in part, to competing service on nearby streets.
- L. **Forced transfer between key origin and destination pairs** – Haskell Indian Nations University is directly linked to KU but not to downtown Lawrence. Some travel between the two campuses exists, but a direct link to downtown may generate stronger ridership.
- M. **Out-of-direction deviation** – Route 15 service to Peaslee Center forces most riders on the route to endure a significant deviation while traveling between downtown and the East Hills Business Park.

Identifying opportunities for improvement provided a starting point for the development of service redesign scenarios. The development of the service scenarios was also informed by stakeholder input. Figure 4-2 shows the responses to a series of trade-off questions presented to riders and non-riders through on-board and online surveys. A full analysis of the survey results is available in Appendix C.

Figure 4-2 | Summary of Customer Preferences*

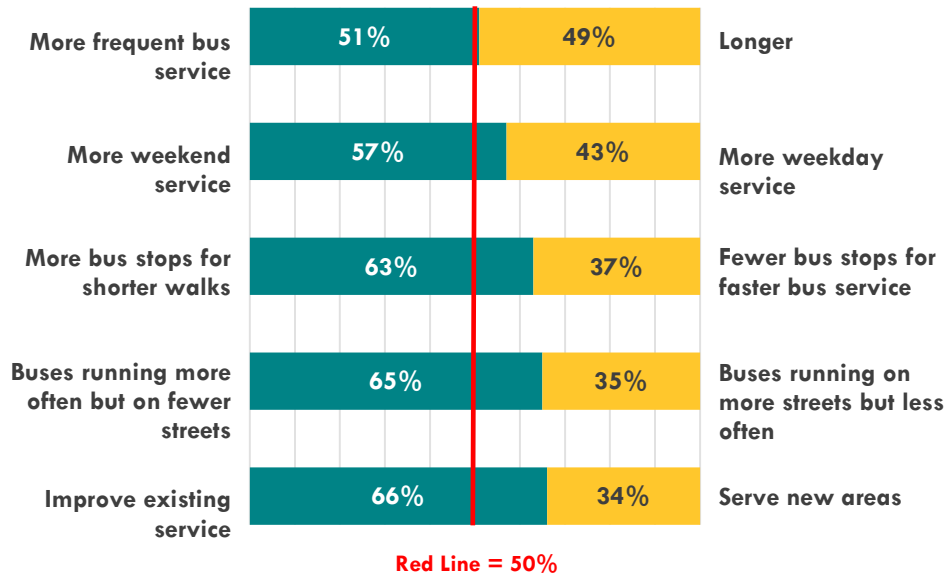

*Total number of respondents: 975; On-board, riders: 765; Online, riders: 124; Online, non-riders: 86

While survey participants were almost evenly split on whether they preferred more frequent service or longer service hours, there was more consensus on several other questions. Sixty-six percent of respondents agreed that improving existing service was a higher priority than serving new areas. This is likely a reflection of the fact that transit coverage in Lawrence is fairly extensive. There are few areas of the city that have the density to support fixed-route service that are not already served. A similarly high percentage of survey takers indicated a preference for service frequency over service coverage.

When asked if more bus stops along a route were preferable to faster travel times, 63 percent preferred more bus stops. This suggests that while improving service frequency is a priority for riders and prospective riders, improving service speed is not. Stated another way, Lawrence residents do not feel that service is currently too slow.

Fifty-seven percent of survey respondents expressed a preference for more weekend service, while 43 percent preferred more service on weekdays. This is likely a reflection of the fact that while transit service in Lawrence does not currently operate on Sundays, the demand for Sunday service still exists.

The survey also asked respondents about their trip origins and destinations and the transit routes used to travel between these points. Figure 4-3 aggregates respondents' origin/destination (O/D) pairs by Census block group. Trips are mapped to and from the centroid of each block group (rather than exact address). Trips with fewer than two occurrences are not shown on this map, but are included in a more detailed O/D matrix in Appendix D.

LAWRENCE TRANSIT COA | SERVICE SCENARIOS

Lawrence-Douglas County MPO

Figure 4-3 | Origins and Destinations by Census Block Group for Survey Respondents

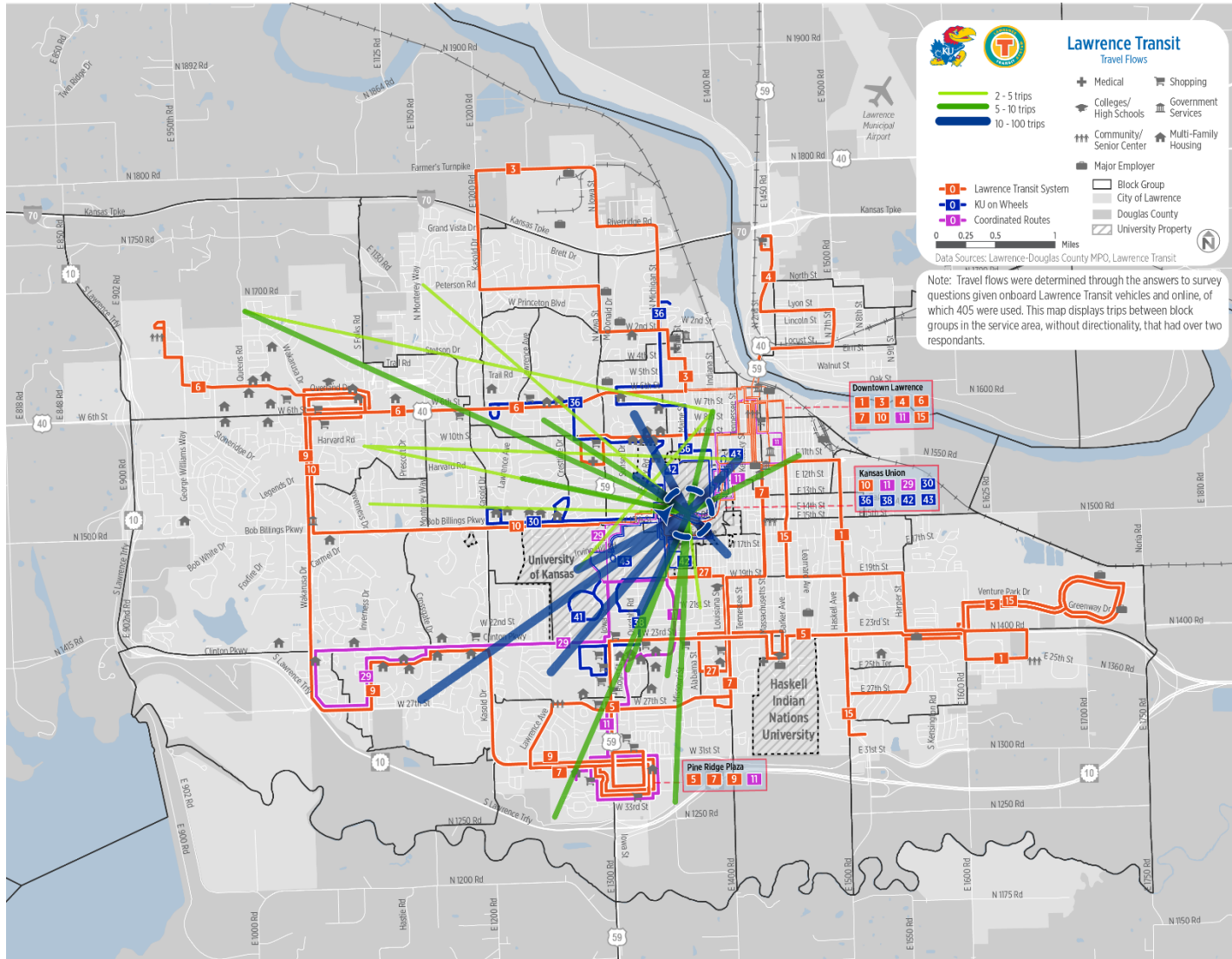

LAWRENCE TRANSIT COA | FINAL REPORT
Lawrence-Douglas County MPO

Out of 550 survey respondents who provided their route information, 203 transferred at least once to complete their trip. Figure 4-4 shows two transfer matrices. The one on the left shows all transfer activity, including transfers that were part of a single trip (i.e. a rider may have transferred twice before reaching their final destination and each of those transfers is treated as a unique transfer activity). The table on the right shows just the first and last routes used to complete a trip, in order to illustrate trip origins and destinations at the route level.

Among survey-takers, Route 11 had the most transfer activity, with 38 transfers from the route (either as the first or second route on respondents' trips) and 50 transfers to the route (either as the second or third route on respondents' trips). Route 11 was also the most frequent final route of a respondent's trip and the second most frequent beginning route (tied with Route 6) of a respondent's trip. In general, most transfer activity occurs within each of the two networks – Lawrence Transit and KUOW – rather than between the two, with the exception of Route 11, which is a coordinated route. The most common individual transfer by far was between KUOW Routes 43 and 41, with most of those occurring from Route 43 to Route 41.

Figure 4-4 | Transfer Activity on Lawrence Transit and KUOW (Left – all transfers; Right – first route/last route)

| FROM | TO | | | | | | | | | | | | | | | TOTAL | | | |
|-------|----|---|----|----|----|----|----|----|----|----|----|----|----|----|----|-------|----|----|-----|
| | 1 | 3 | 4 | 5 | 6 | 7 | 9 | 10 | 11 | 15 | 27 | 29 | 30 | 36 | 38 | 41 | 42 | 43 | |
| 1 | | | 3 | 5 | 4 | 3 | | 1 | 6 | 3 | | | | | | | | | 25 |
| 3 | 1 | | | | | 1 | 1 | | | | | | | | | | | | 3 |
| 4 | | | | 1 | 4 | 3 | 1 | | 1 | | | | 1 | | | | | | 11 |
| 5 | 2 | | 1 | | | | 3 | 1 | | 1 | 1 | | | | | | | | 9 |
| 6 | 3 | 1 | 2 | | | 6 | 4 | 6 | 11 | | | | | | | | | | 33 |
| 7 | 3 | | | 2 | 2 | | 2 | 1 | 4 | 1 | | 1 | | | 1 | | | | 17 |
| 9 | | | | 1 | 1 | 1 | | 1 | 1 | | | | | | | | | | 5 |
| 10 | | 1 | 2 | | 2 | | 3 | | 1 | | | | 4 | | | 1 | | | 14 |
| 11 | 1 | 1 | 1 | 3 | 1 | 5 | 1 | 3 | | | 3 | 3 | 2 | 3 | 3 | 5 | 1 | 2 | 38 |
| 15 | | 1 | 1 | 1 | 3 | 1 | | | 1 | | | | | | | | | | 8 |
| 27 | | | | | | | 1 | | | | | | 1 | | | | 2 | | 4 |
| 29 | | | | | | 1 | 2 | | 3 | | | | 1 | | 1 | | | 1 | 9 |
| 30 | | | | | | | | 4 | 2 | | | | | | | 1 | 1 | | 8 |
| 36 | | | 2 | | 3 | | 1 | | 3 | | | | | | | | 2 | 2 | 13 |
| 38 | | | | | | | | 1 | 8 | | 2 | 2 | | | | | 4 | 2 | 19 |
| 41 | | | | | | | | 1 | 4 | | | 2 | 2 | | 1 | | 2 | 4 | 16 |
| 42 | | | | | | | | | 1 | | | | | 1 | 4 | | | 2 | 8 |
| 43 | | | | | | | | | 3 | | 6 | 1 | 1 | 2 | 20 | | 2 | | 35 |
| TOTAL | 10 | 4 | 12 | 13 | 21 | 25 | 15 | 18 | 50 | 5 | 5 | 14 | 12 | 5 | 13 | 27 | 13 | 13 | 275 |

| FIRST ROUTE | LAST ROUTE | | | | | | | | | | | | | | | TOTAL | | | |
|-------------|------------|---|---|---|----|----|----|----|----|----|----|----|----|----|----|-------|----|----|-----|
| | 1 | 3 | 4 | 5 | 6 | 7 | 9 | 10 | 11 | 15 | 27 | 29 | 30 | 36 | 38 | 41 | 42 | 43 | |
| 1 | | | 2 | 2 | 3 | 4 | 1 | | 6 | 2 | | | 1 | | | | | | 21 |
| 3 | 1 | | | | | 1 | 1 | | | | | | | | | | | | 3 |
| 4 | | | | | 1 | 3 | 2 | 1 | 1 | | | | | | | | | | 8 |
| 5 | | | | | 1 | 1 | 1 | | | 2 | | | | | | | | | 5 |
| 6 | 1 | 2 | 2 | 1 | | 7 | 2 | 3 | 6 | | | | | 1 | | | | 25 | |
| 7 | 3 | | | 1 | 2 | | 1 | 1 | 2 | 1 | | 1 | | | | | 1 | 13 | |
| 9 | | | | 1 | 1 | 1 | | | 1 | | | | | | | | | 4 | |
| 10 | | | 1 | | | | 2 | | | | | | 4 | 1 | | 1 | | 9 | |
| 11 | 1 | 1 | 1 | 2 | 1 | 3 | 4 | 2 | | | 1 | | 1 | 1 | 1 | 2 | 1 | 3 | 25 |
| 15 | | 1 | 1 | 2 | 2 | 1 | | | | | | 1 | | | | | | 8 | |
| 27 | | | | | | | | | | | | | | | 1 | | 1 | | 2 |
| 29 | | | | | | | | | | | | | | | | | | | 2 |
| 30 | | | | | | | | | 2 | | 1 | | | | | 1 | | | 4 |
| 36 | | | 2 | | 1 | | 1 | 2 | 3 | | | | | | | | 1 | 3 | 13 |
| 38 | | | | | | | | | 6 | | | | | | | 2 | 5 | | 13 |
| 41 | | | | | | | | 2 | 2 | | | 1 | 1 | | | | 2 | 2 | 10 |
| 42 | | | | | | | | | | | | 1 | | 1 | 3 | | | 1 | 6 |
| 43 | | | | | | | | | | 8 | | 4 | 1 | 1 | 2 | 15 | 1 | | 32 |
| TOTAL | 6 | 4 | 9 | 9 | 13 | 21 | 14 | 13 | 37 | 5 | 3 | 7 | 8 | 5 | 7 | 21 | 11 | 10 | 203 |

The Nelson\Nygaard team developed two service redesign scenarios aimed at addressing the service improvement opportunities identified in Figure 24, as well as the service design and travel preferences established through the transit survey. These are described below.

SCENARIO I

Figure 4-5 and Figure 4-6 present a system map of Scenario I followed by a route-by-route description of each proposed service change.

LAWRENCE TRANSIT COA | FINAL REPORT
Lawrence-Douglas County MPO

Figure 4-5 | Scenario I System Map

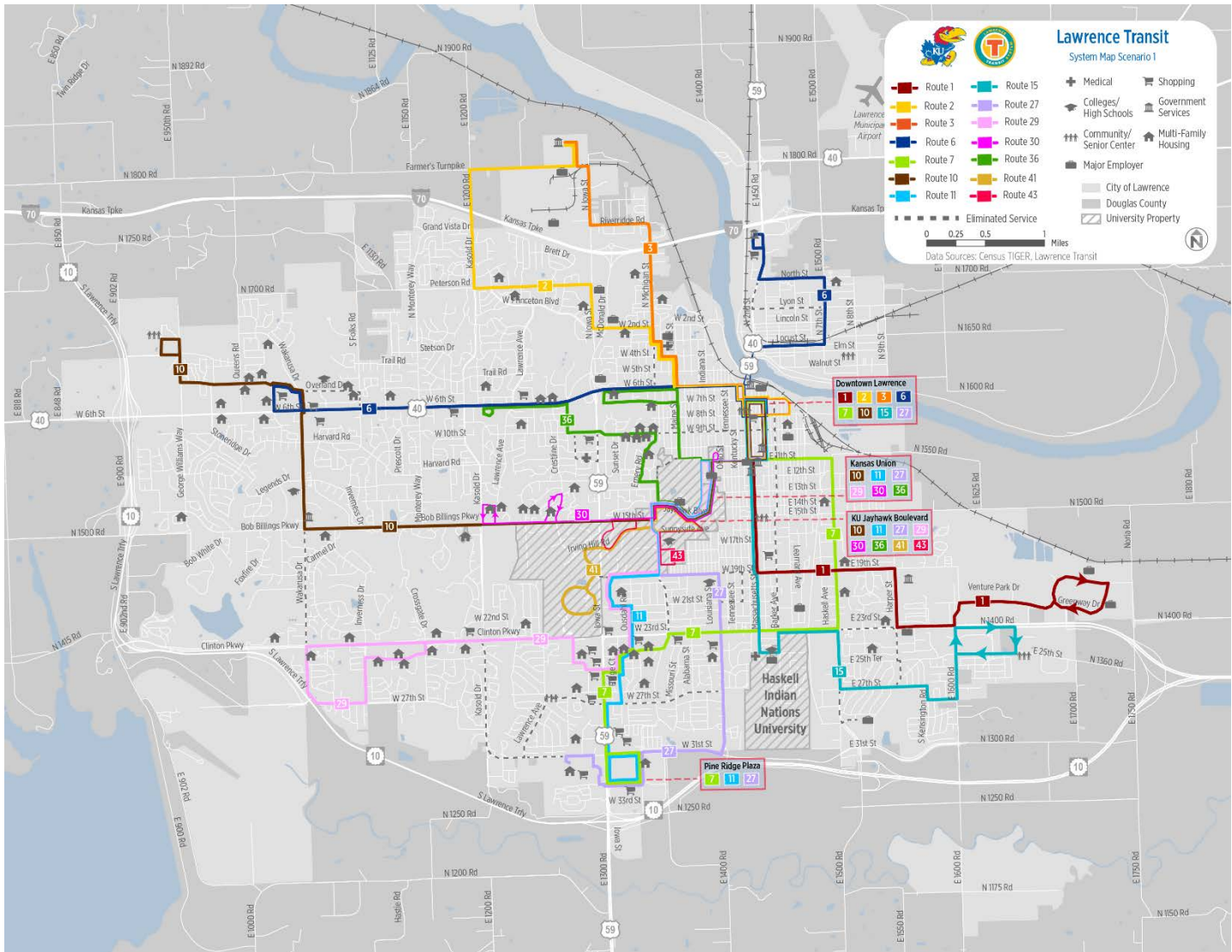

Figure 4-6 | Scenario I Description of Proposed Service Changes

| Existing Route | Scenario I |
|----------------|---|
| 1 | <ul style="list-style-type: none"> ▪ Connect downtown Lawrence and East Hills Business Park via Massachusetts St., 19th St., and Harper St. ▪ Provide one-seat ride between residential areas, including mobile home parks near Harper St., and retail/grocery destinations on Massachusetts St. |
| 3 | <ul style="list-style-type: none"> ▪ Split route into two routes (Route 2 and Route 3) to provide bi-directional service on each route ▪ Operate Route 2 along 2nd Ave., Peterson Rd., Kasold Dr., and Farmers Tpke; operate Route 3 along Michigan St., Riverridge Rd., and Iowa St. |
| 4 | <ul style="list-style-type: none"> ▪ Eliminate (see Route 6) |
| 5 | <ul style="list-style-type: none"> ▪ Eliminate (see Routes 1 & 7) |
| 6 | <ul style="list-style-type: none"> ▪ Connect North Lawrence to Walmart on 6th St. via downtown Lawrence ▪ Provide one-seat ride between North Lawrence and retail destinations on 6th St. |
| 7 | <ul style="list-style-type: none"> ▪ Connect downtown Lawrence and Pine Ridge Plaza/ Walmart via Haskell Ave., 23rd St., and Iowa St. ▪ Provide one-seat ride between high concentration of apartments along Haskell Ave., and both downtown Lawrence and south Lawrence retail destinations |
| 9 | <ul style="list-style-type: none"> ▪ Eliminate due to low ridership (see Routes 10 & 29) |
| 10 | <ul style="list-style-type: none"> ▪ Connect Rock Chalk Park and downtown Lawrence via Bob Billings Pkwy and KU |

LAWRENCE TRANSIT COA | FINAL REPORT
Lawrence-Douglas County MPO

| Existing Route | Scenario I |
|----------------|--|
| 11 | <ul style="list-style-type: none"> ▪ Shift alignment north of 24th St. to current Route 38 alignment ▪ Coordinate with Route 29 to provide high frequency service between 24th St. and KU, allowing for the elimination of Route 38 |
| 15 | <ul style="list-style-type: none"> ▪ Connect downtown Lawrence to Lawrence Community Shelter via Massachusetts St., HINU, and 27th St. |
| 27 | <ul style="list-style-type: none"> ▪ Connect downtown Lawrence to south Lawrence retail destinations via KU, Louisiana St., and 31st St. |
| 29 | <ul style="list-style-type: none"> ▪ Connect high concentration of apartments along Clinton Pkwy to KU via 24th St. ▪ Shift alignment north of 24th St. to current Route 38 alignment ▪ Coordinate with Route 11 to provide high frequency service between 24th St. and KU, allowing for the elimination of Route 38 |
| 30 | <ul style="list-style-type: none"> ▪ Extend route to GSP |
| 36 | <ul style="list-style-type: none"> ▪ Eliminate service along Michigan St. north of 6th St. (see Routes 2 & 3) |
| 38 | <ul style="list-style-type: none"> ▪ Eliminate (see Routes 11 & 29) |
| 41 | <ul style="list-style-type: none"> ▪ No change |
| 42 | <ul style="list-style-type: none"> ▪ Eliminate (see Route 43) |
| 43 | <ul style="list-style-type: none"> ▪ Connect Daisy Hill to KU Recreation Center via Jayhawk Blvd. and Sunnyside Ave. ▪ Set up service for expansion into a full loop after completion of Central District |

The principal ways in which Scenario I addressed the previously identified service improvement opportunities include the following:

- Restructuring Route 7 to link apartment complexes along Haskell Avenue to retail and grocery destinations in south Lawrence,
- Incorporating the North Lawrence segment of Route 4 into Route 6 to provide one-seat service between North Lawrence and several retail and grocery destinations along 6th Street,
- Simplifying downtown circulation by operating northbound service on Vermont Street and downtown service on New Hampshire Street,
- Eliminating Route 36 service along North Michigan Street to reduce unproductive service,
- Splitting Route 3 into two separate routes with bi-directional service on both routes,
- Serving Rock Chalk Park with an extension of Route 10, rather than Route 6, in order to directly link the sports complex to the KU campus,
- Eliminating Route 9 due to low ridership and poor transit potential along segments of Wakarusa Drive and Kasold Drive,
- Consolidating service between Clinton Parkway/Iowa Street and KU to allow for the elimination of one route (Route 38),
- Simplifying KU campus circulation by eliminating Route 42 and restructuring Route 43 to serve the Rec Center,
- Consolidating service south of downtown along Massachusetts Street to maximize frequency on the corridor,
- Providing a direct link between HINU and downtown Lawrence via Route 15,
- Eliminating direct service to the Peaslee Center in order to streamline service for Prairie Park and Lawrence Community Shelter residents.

Scenario I proposed the elimination of several routes to address low ridership and/or opportunities for service consolidation. The elimination of Routes 5, 9, 38, and 42 would free-up resources and allow for the development of a more robust service schedule with longer hours and higher frequencies. The proposed Scenario I schedule (see Figure 4-7) featured 30-minute service or better on every route during peak periods. During off-peak periods, only one route (Route 15) would drop below 30-minute service frequency.

LAWRENCE TRANSIT COA | FINAL REPORT
Lawrence-Douglas County MPO

Figure 4-7 | Scenario I Proposed Schedule and Frequency*

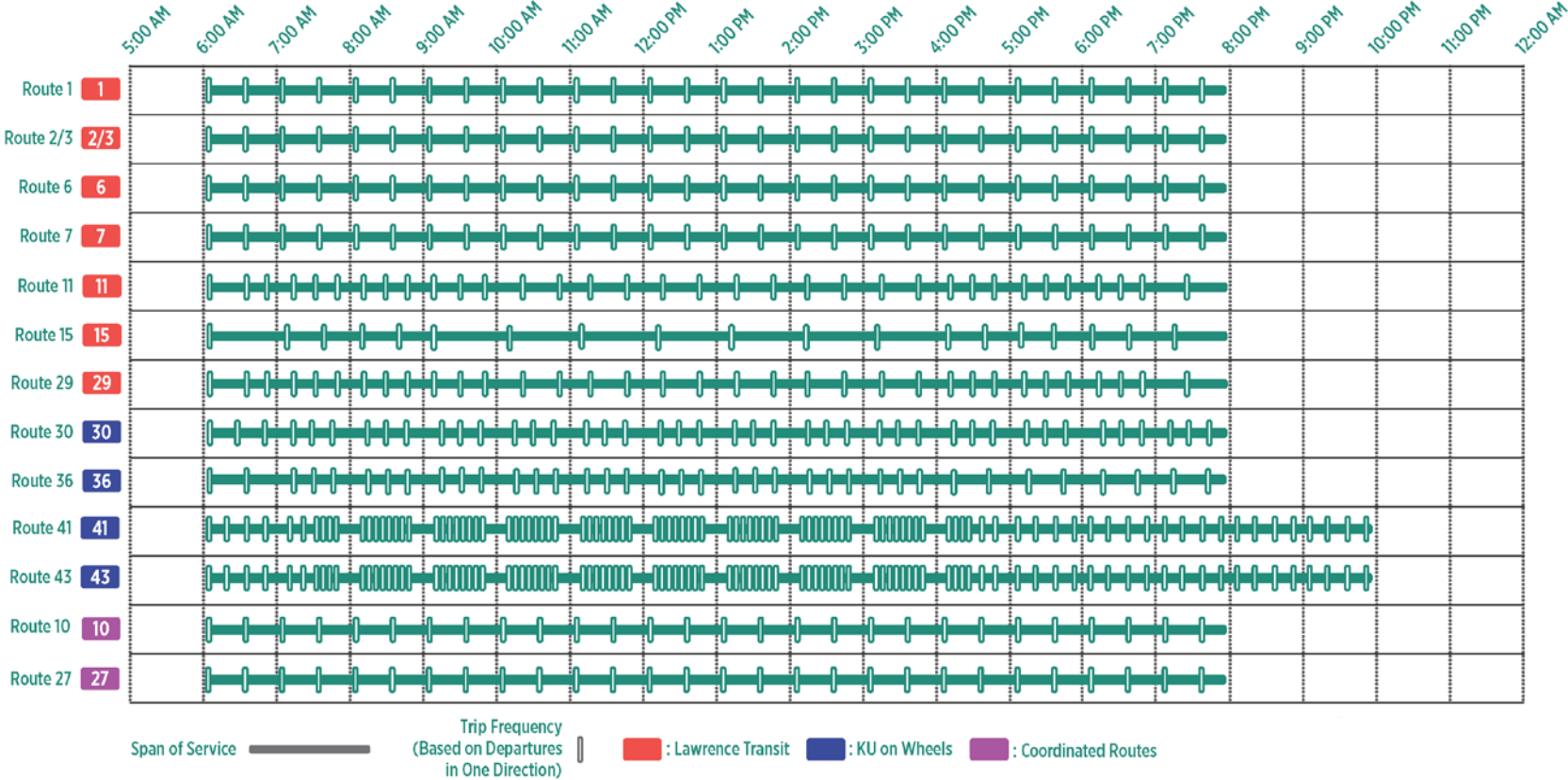

*Each cell of the above chart represents one hour of service and each dash represents one bus trip within that hour, approximating service hours and frequency of each route. The chart is not meant to represent exact service span or bus arrival/departure times.

SCENARIO II

Scenario II was meant to present a second set of service improvement options while helping to gauge public support for competing approaches. Key differences from Scenario I included the following:

- Combining service to the East Hills Business Park and Lawrence Community Shelter on a single route (Route 1),
- Truncating Route 15 at the Peaslee Center,
- Restoring Route 38 service while eliminating Route 11,
- Restructuring Route 29 to service Walmart in south Lawrence rather than KU,
- Reducing the coverage area of Route 2 in north Lawrence.

Figure 4-8 and Figure 4-9 show the proposed system map for Scenario II followed by a side-by-side comparison of the service changes associated with each scenario. The proposed service schedule for Scenario II includes two routes with hourly service frequency in the off-peak period (see Figure 4-10), but is otherwise similar to Scenario I in extending service hours and providing 30-minute service or better on all routes during peak periods.

LAWRENCE TRANSIT COA | FINAL REPORT
Lawrence-Douglas County MPO

Figure 4-8 | Scenario II System Map

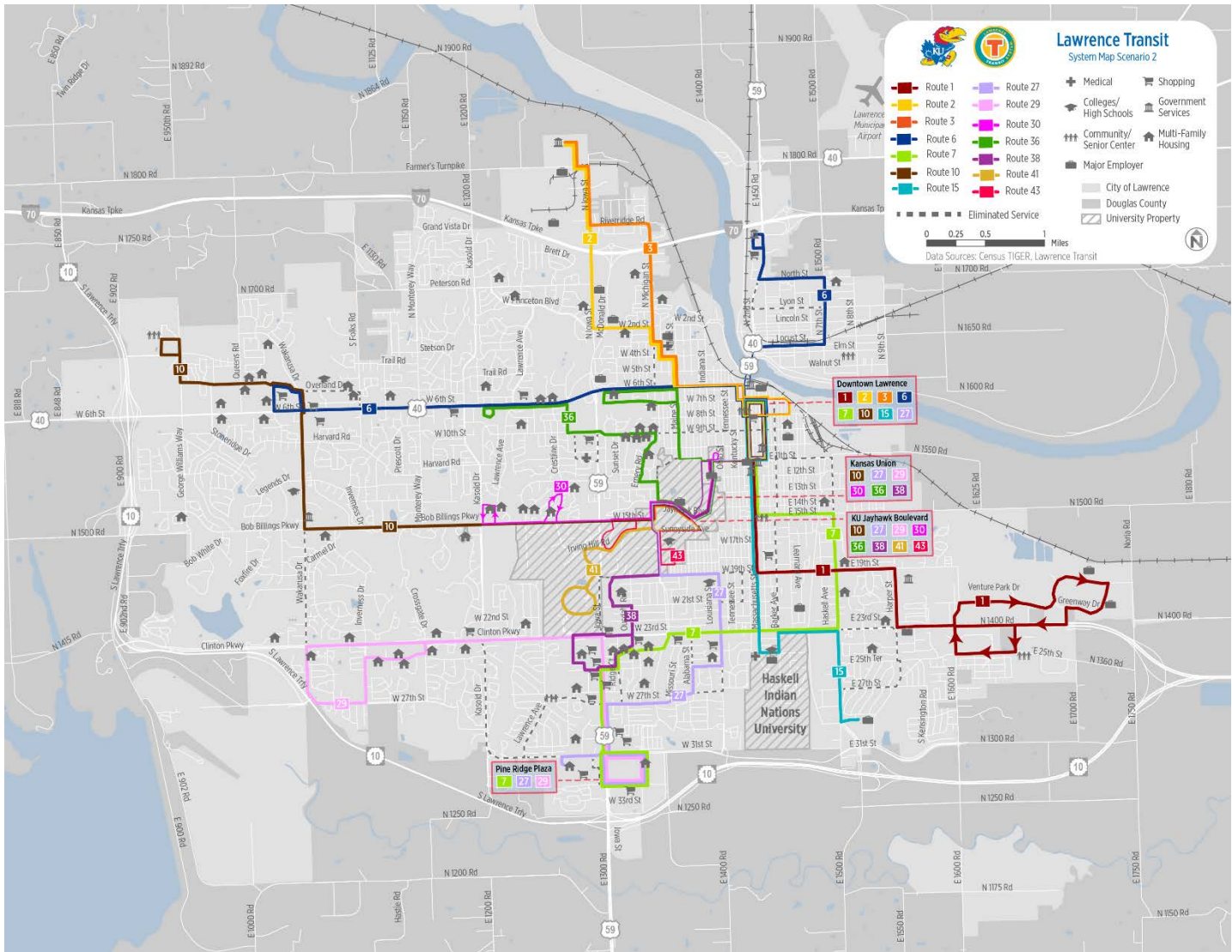

LAWRENCE TRANSIT COA | SERVICE SCENARIOS
Lawrence-Douglas County MPO

Figure 4-9 | Scenario II Description of Proposed Service Changes

| Existing Route | Scenario I | Scenario II |
|----------------|---|---|
| 1 | <ul style="list-style-type: none"> ▪ Connect downtown Lawrence and East Hills Business Park via Massachusetts St., 19th St., and Harper St. ▪ Provide one-seat ride between residential areas, including mobile home parks near Harper St., and retail/grocery destinations on Massachusetts St. | <ul style="list-style-type: none"> ▪ Connect downtown Lawrence with Lawrence Community Shelter and East Hills Business Park via Massachusetts St., 19th St., and Harper St. ▪ Provide one-seat ride between residential areas, including mobile home parks near Harper St., and retail/grocery destinations on Massachusetts St. |
| 3 | <ul style="list-style-type: none"> ▪ Split route into two routes (Route 2 and Route 3) to provide bi-directional service on each route ▪ Operate Route 2 along 2nd Ave., Peterson Rd., Kasold Dr., and Farmers Tpk; operate Route 3 along Michigan St., Riverridge Rd., and Iowa St. | <ul style="list-style-type: none"> ▪ Split route into two routes (Route 2 and Route 3) to provide bi-directional service on each route ▪ Operate Route 2 along 2nd Ave. and Iowa St.; operate Route 3 along Michigan St., Riverridge Rd., and Iowa St. |
| 4 | <ul style="list-style-type: none"> ▪ Eliminate (see Route 6) | <ul style="list-style-type: none"> ▪ Eliminate (see Route 6) |
| 5 | <ul style="list-style-type: none"> ▪ Eliminate (see Routes 1 & 7) | <ul style="list-style-type: none"> ▪ Eliminate (see Routes 1 & 7) |
| 6 | <ul style="list-style-type: none"> ▪ Connect North Lawrence to Walmart on 6th St. via downtown Lawrence ▪ Provide one-seat ride between North Lawrence and retail destinations on 6th St. | <ul style="list-style-type: none"> ▪ Connect North Lawrence to Walmart on 6th St. via downtown Lawrence ▪ Provide one-seat ride between North Lawrence and retail destinations on 6th St. |
| 7 | <ul style="list-style-type: none"> ▪ Connect downtown Lawrence and Pine Ridge Plaza/ Walmart via Haskell Ave., 23rd St., and Iowa St. ▪ Provide one-seat ride between high concentration of apartments along Haskell Ave., and both downtown Lawrence and south Lawrence retail destinations | <ul style="list-style-type: none"> ▪ Connect downtown Lawrence and Pine Ridge Plaza/ Walmart via Haskell Ave., 23rd St., and Iowa St. ▪ Provide one-seat ride between high concentration of apartments along Haskell Ave., and both downtown Lawrence and south Lawrence retail destinations |
| 9 | <ul style="list-style-type: none"> ▪ Eliminate due to low ridership (see Routes 10 & 29) | <ul style="list-style-type: none"> ▪ Eliminate due to low ridership (see Routes 10 & 29) |
| 10 | <ul style="list-style-type: none"> ▪ Connect Rock Chalk Park and downtown Lawrence via Bob Billings Pkwy and KU | <ul style="list-style-type: none"> ▪ Connect Rock Chalk Park and downtown Lawrence via Bob Billings Pkwy and KU |

LAWRENCE TRANSIT COA | FINAL REPORT
Lawrence-Douglas County MPO

| Existing Route | Scenario I | Scenario II |
|----------------|--|---|
| 11 | <ul style="list-style-type: none"> Shift alignment north of 24th St. to current Route 38 alignment Coordinate with Route 29 to provide high frequency service between 24th St. and KU, allowing for the elimination of Route 38 | <ul style="list-style-type: none"> Eliminate (see Routes 29 & 38) |
| 15 | <ul style="list-style-type: none"> Connect downtown Lawrence to Lawrence Community Shelter via Massachusetts St., HINU, and 27th St. | <ul style="list-style-type: none"> Connect downtown Lawrence to Peaslee Center via Massachusetts St., HINU, and Haskell Ave. |
| 27 | <ul style="list-style-type: none"> Connect downtown Lawrence to south Lawrence retail destinations via KU, Louisiana St., and 31st St. | <ul style="list-style-type: none"> Connect downtown Lawrence to south Lawrence retail destinations via KU, Louisiana St., 27th St., and Iowa St. |
| 29 | <ul style="list-style-type: none"> Connect high concentration of apartments along Clinton Pkwy to KU via 24th St. Shift alignment north of 24th St. to current Route 38 alignment Coordinate with Route 11 to provide high frequency service between 24th St. and KU, allowing for the elimination of Route 38 | <ul style="list-style-type: none"> Connect high concentration of apartments along Clinton Pkwy with Pine Ridge Plaza/Walmart Access to KU available via transfer to Route 38 |
| 30 | <ul style="list-style-type: none"> Extend route to GSP | <ul style="list-style-type: none"> Extend route to GSP |
| 36 | <ul style="list-style-type: none"> Eliminate service along Michigan St. north of 6th St. (see Routes 2 & 3) | <ul style="list-style-type: none"> Eliminate service along Michigan St. north of 6th St. (see Routes 2 & 3) |
| 38 | <ul style="list-style-type: none"> Eliminate (see Routes 11 & 29) | <ul style="list-style-type: none"> Expand southern terminal loop to include apartments east and west of Iowa St. |
| 41 | <ul style="list-style-type: none"> No change | <ul style="list-style-type: none"> No change |
| 42 | <ul style="list-style-type: none"> Eliminate (see Route 43) | <ul style="list-style-type: none"> Eliminate (see Route 43) |
| 43 | <ul style="list-style-type: none"> Connect Daisy Hill to KU Recreation Center via Jayhawk Blvd. and Sunnyside Ave. Set up service for expansion into a full loop after completion of Central District | <ul style="list-style-type: none"> Connect Daisy Hill to KU Recreation Center via Jayhawk Blvd. and Sunnyside Ave. Set up service for expansion into a full loop after completion of Central District |

LAWRENCE TRANSIT COA | SERVICE SCENARIOS
Lawrence-Douglas County MPO

Figure 4-10 | Scenario II Proposed Schedule and Frequency*

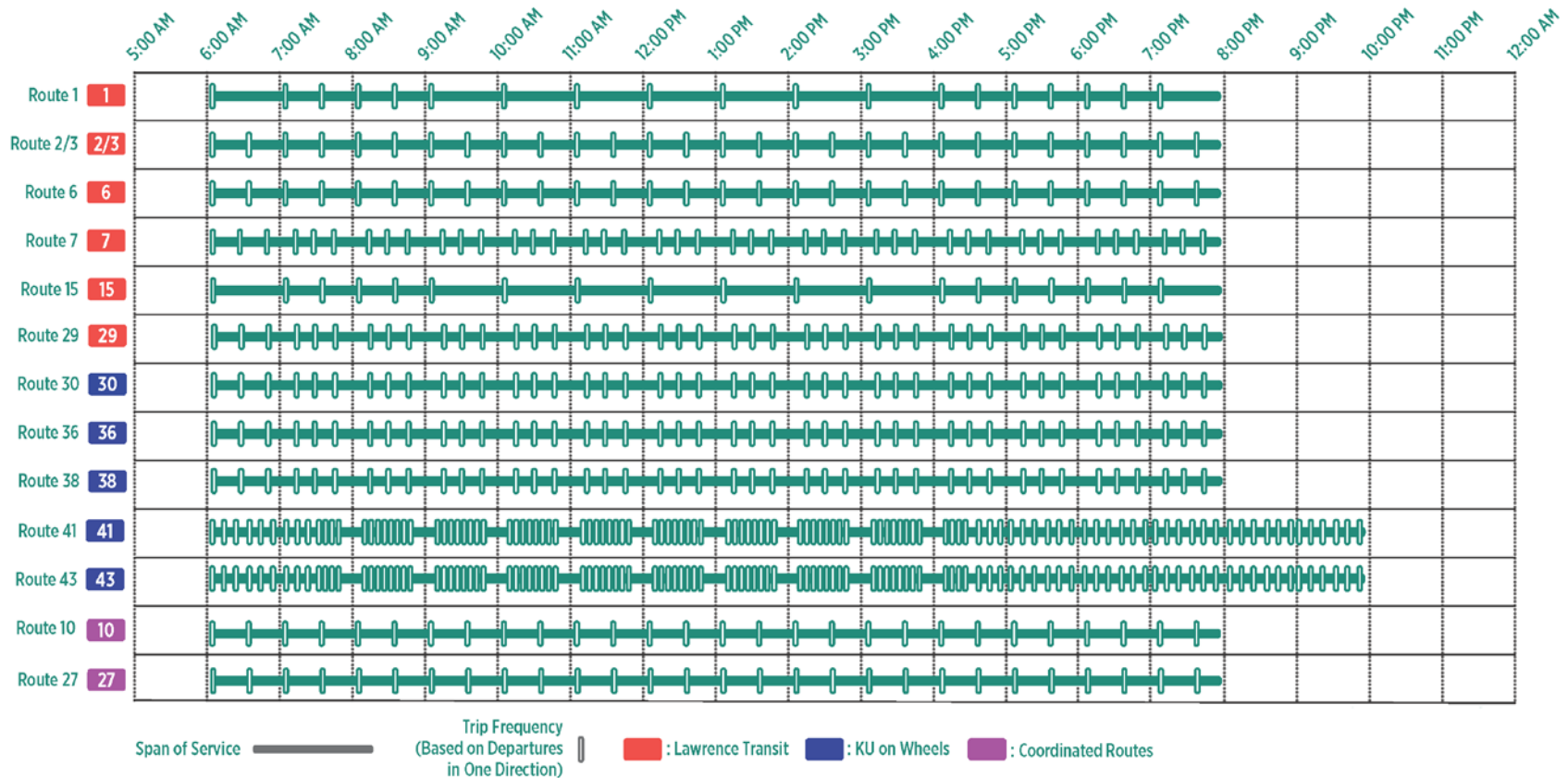

*Each cell of the above chart represents one hour of service and each dash represents one bus trip within that hour, approximating service hours and frequency of each route. The chart is not meant to represent exact service span or bus arrival/departure times.

PUBLIC FEEDBACK

In October 2016, Lawrence Transit, KUOW, the MPO, and Nelson\Nygaard held community meetings in Lawrence and at KU to gather feedback on the preliminary scenarios. All of the meetings were advertised on-board the buses, on the lawrencetransitstudy.com website, and via an official press release from the MPO. Along with large maps of the proposed service networks, the study team developed display boards for both scenarios that included the proposed schedule, and the existing ridership and transit potential overlaid with the proposed networks. A fifth board allowed for public meeting participants to vote on the service scenario they preferred most. Corresponding pages on the website and an online survey were also developed. The website included interactive maps of both scenarios, a written description of the proposed changes, a video recording of the presentation given at the public meetings, and the actual slides from the public meeting presentation. The most frequent comments expressed at these events are summarized below.

- Community members expressed support for improving service overall and many of the changes were seen as positive. When asked to choose just one service scenario, the overwhelming majority of residents expressed a preference for proposed Scenario I.
- Online comments and public meeting attendees expressed concern about the potential loss of service or reduced service in the following areas:
 - Between KU and Rockland East apartments at West 24th Street and Naismith Drive,
 - Between the West 31st Street retail area and Daisy Hill and West Campus,
 - Between HINU and KU,
 - Between KU and destinations along Michigan Street,
 - Holcom Park Recreation Center and Lawrence Avenue,
 - West 9th Street.
- Numerous commenters preferred that Route 29 continue direct service to the university, as in Scenario I, but generally liked the improvements to circulation along Iowa Street near West 23rd Street/Clinton Parkway and at the retail area on West 31st Street.
- Community members viewed the addition of Route 2 and improved Route 3 positively.
- Community members expressed concern over the potential elimination of bus service in west Lawrence.
- More frequency, Sunday service, and increased service when KU is not in session are generally supported by the public in Lawrence.

Detailed notes for each community meeting/event, as well as comments received online, are provided below.

University Public Meeting & Drop-In Session (October 26, 2016)

On Wednesday, October 26th, the study team focused on hearing from KU students, faculty, and staff. During the lunch hour, the team was available in the lobby of the Kansas Union for anyone to drop-by and provide comments on the two scenarios. Later in the afternoon, the team held a public meeting in the Union, which included a formal presentation, question-and-answer period, and open house-style format afterward.

- Several commenters mentioned that both scenarios lack service along Lawrence Avenue and West 31st Street west of The Reserve, streets which provide direct service to churches, Cottonwood, Inc., a residential neighborhood, and Holcom Park Recreation Center
- Several students thought the new Route 42 would be a big hit with students
- A few commenters mentioned higher service frequency – both the recent increase in frequency on some routes and the need for more increases – as necessary improvements
- One person, commenting on Scenario II, said that Route 29 should serve the university
- Students thought that the lack of direct connection between the Daisy Hill residential area on campus and the retail area to the south on Route 11 will not be viewed favorably
- A disabled resident said that the pedestrian and ADA accessibility, especially the maintenance and condition of the sidewalks, is a big problem in Lawrence; he also thought that T Lift is very inconvenient for spontaneous trips (the pick-up window is too long), and T Lift buses are too big and never full
- One student mentioned that KU should lengthen Route 41 to cover more of campus
- Several students mentioned service to Kansas City should be improved – the delays and frequency of the K-10 Connector should be fixed, and the university needs to add a connection to the KU Medical Center if they require students to take classes in Lawrence
 - *The K-10 Connector and additional commuter services to Kansas City were outside the scope of this project*
- Overall, most commenters preferred Scenario I over Scenario II

Lawrence Public Meetings (October 27, 2016)

On Thursday, October 27th, the team heard from the broader Lawrence community. We held two public meetings during working hours at the Lawrence Public Library and an evening public meeting at the Carnegie Building. These were in the same format as the University public meeting held the previous day.

- One senior citizen requested Sunday service
- One attendee discussed adding north-south service along Iowa Street and Kasold Drive
 - He suggested taking Route 36 down Kasold Drive, operating express for most of the way but stopping at Bob Billings and Clinton Parkways to provide transfer points
- Views on Scenario I:
 - Liked the changes to Route 7
 - Liked the new Route 2/3
 - Route 11/29 coordination (more frequency on common segment) is great
 - Unfavorable view of removing service from Lawrence Avenue and Holcom Park Recreation Center; attendees did not want to lose that connection
 - Ok with eliminating Route 9
 - Worried about access to Lawrence High School
- Views on Scenario II:
 - Weekend service on 29 may work but will not work during the weekday; weekday service would add another transfer since riders often use KU as a transfer point
 - Too hard to get between Peaslee and Lawrence Community Shelter with transfer

- Amenable to Uber/Lyft type service
- Again, most attendees favored Scenario I over Scenario II

Online Service Scenario Survey

The online survey included information about the two scenarios and asked respondents to vote for the scenario they preferred most, though they were also allowed to choose neither or that they liked aspects of each. The survey was open from October 25 to November 28, 2016. In total, there were 113 respondents, with 58.9 percent of those employed full- or part-time and 29.5 percent students. The remaining 12 percent was made up of retirees, those who are unemployed, and stay-at-home caregivers.

Similar to the public meetings, respondents generally preferred Scenario I (25.7 percent) over Scenario II (9.7 percent). However, as shown in Figure 4-11, the majority of respondents would like to keep the system unchanged (31.0 percent). The other 33.7 percent said that they like parts of both or “other”. The “other” comments were largely general comments about the system, those who did not understand the changes or see much of a difference between the two, or were repeated in the subsequent comment boxes where the survey asked for specific feedback on both scenarios separately.

Figure 4-11 | Scenario Preference of Online Survey Respondents

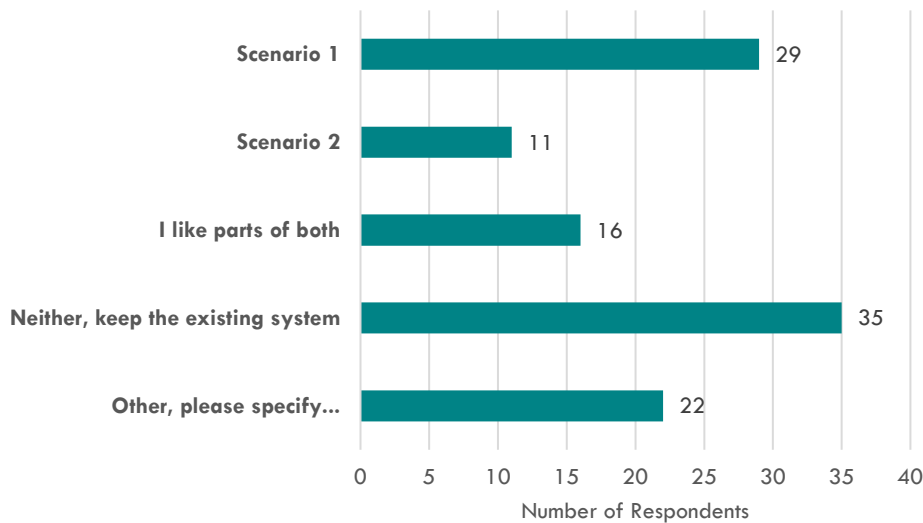

After voting for their preference, respondents had the opportunity to provide additional feedback on each of the scenarios. Comments from these open-ended questions are summarized below, with the frequency of the comment in parentheses:

- General:
 - Later service needed (3)
 - Run KU routes year-round (2)
 - Buses should run on Sunday and Stop Day (2)
 - The service to East Lawrence has been continually decreased (2)
 - More frequency needed (1)

LAWRENCE TRANSIT COA | SERVICE SCENARIOS
Lawrence-Douglas County MPO

- Having the buses run every 30 minutes has improved ridership and will continue to do so (1)
- Route 11 needs to be simplified and run more frequently (1)
- Do not deprive The Reserve of service; it has high ridership and many university students live in this large apartment complex (1)
- A lot of school-age children rely on the city buses to get to and from school (1)
- Route 1 schedule should be adjusted to get riders to the East Hills Business Park in time for shifts (1)
- Improvements needed to the MV Transit smartphone app, the text service, and the website for reroutes and service updates (1)
- More hybrid buses (1)
- Keep the stop at the Holcom Park Recreation Center (1)
- Drivers are polite and service is punctual (1)
- There needs to be more provisions for door-to-door service and increased mobility for those in wheelchairs, not simply just meeting ADA codes (1)
- Scenario I:
 - Should not remove the direct route between HINU and KU because students may take classes on both campuses (10)
 - The service along Michigan Street is already minimal and this scenario makes it much worse to reach campus from this area (4)
 - A route between downtown and The Merc should remain; keep east-west connection on W. 9th Street (3)
 - Route 2 covering a wider area is good (3)
 - Route 29 in this scenario is better (2)
 - Need to make campus easily accessible to students living off-campus, especially with new apartments being built downtown (2)
 - Need a direct connection between the Rockland East apartments and campus because a lot of students live in the Rockland East apartments (2)
 - Daisy Hill and West Campus need direct connections off-campus, especially to the south retail area, not just routes that circulate on campus (2)
 - The combination of Route 6 with Route 4 is a good idea (2)
 - There should be a route that takes Clinton Parkway all the way from east-west (2)
 - Both scenarios provide less service to East Lawrence; there should be better connections to downtown and campus from east of downtown (2)
 - Keep Route 38 as is (1)
 - Route 11 should still go to Massachusetts Street (1)
 - Do not change Route 11 (1)
 - The common stop for Route 5, 7, and 11 is great (1)
 - The routes through the Lawrence Venture Park are good (1)
 - Route 11 will not go as close to the Dillons on W. 23rd Street (1)
 - Connection between Route 29 and downtown is too long in this scenario (1)

- This new version of Route 7 will be inconvenient; keep Route 7 as is (1)
- Need service to Holcom Park Recreation Center (1)
- This scenario has better connectivity to southeast Lawrence, which is needed (1)
- The proposed scenario reduces the transit service between west Lawrence and the south retail area, making options and service time much worse (1)
- Does not connect the north and south sides of west Lawrence (1)
- Route 27 will be overloaded since the route will be picking up students who live at The Connection, The Reserve, and Lawrence High School students (1)
- Covers a larger area than Scenario II (1)
- Transfer between Route 6 and Route 10 is good (1)
- The south end of Route 11 is simpler, which is good (1)
- The alignment of Route 7 on 11th Street in Scenario I better than its 15th Street alignment in Scenario II (1)
- Core routes that run up Connecticut Street should be brought back (1)
- The distribution of service between Route 15 and Route 1 south of Clinton Parkway/ W. 23rd Street is better in Scenario 2 than in Scenario 1 (1)
- The changes to Route 30 and 43 are great (1)
- Scenario II:
 - Should not remove the direct route between HINU and KU because students may take classes on both campuses (8)
 - The Merc and 9th Street should be connected to downtown (3)
 - Need a direct connection between campus and the area surrounding the Rockland East apartments because a lot of students live there (2)
 - Route 29 should continue to serve the university; no easy access to downtown from Route 29 in this scenario; connecting from Route 29 to Route 38 will be unavailable in the summer (3)
 - Daisy Hill and West Campus need direct connections off-campus, especially to the south retail area, not just routes that circulate on campus (2)
 - The service along Michigan Street is already minimal and this scenario makes it much worse to reach campus from this area (2)
 - Poor access to far southeast corner of town (1)
 - This one keeps Route 38 unchanged, which is better (1)
 - Operate Route 36 all year (1)
 - Route 11 should still reach Massachusetts Street (1)
 - Route 2 and Route 3 are good (1)
 - Core routes that run up Connecticut Street should be brought back (1)
 - Options to get to campus from east of downtown are limited (1)
 - Route 1 taking more load, and Route 15 going directly to the workforce center is sorely needed (1)
 - Route 38 is great idea (1)

LAWRENCE TRANSIT COA | SERVICE SCENARIOS
Lawrence-Douglas County MPO

- The proposed scenario reduces the transit service between west Lawrence and the south retail area, making options and service time much worse (1)
- There should be a stop on W. 8th Street and Kentucky Street and again in front of the Senior Center (1)
- A lot of replicated service (1)
- Does not connect the north and south sides of west Lawrence (1)
- Change to Route 36 is good (1)
- The routes are simpler and easier to understand (1)
- Route 15 is much better in this scenario (1)
- Keep Route 11 as is (1)
- Routes 27 and 29 are better in this scenario (1)
- Keep Route 27 as is (1)

With the understanding that the public would select elements of both scenarios that they like, suggest new ideas, and/or prefer existing elements of the service, the study team developed a final set of recommendations based on the public comments and input from stakeholders. These final recommendations are discussed in the next chapter.

5 FINAL SERVICE RECOMMENDATIONS

PROPOSED FIXED-ROUTE SERVICE PLAN

Based on the feedback received online and at the October 2016 public meetings, the Nelson\Nygaard team developed a final recommended service redesign scenario. The final recommended scenario includes elements from both Scenario I and Scenario II, as well as new recommendations developed in response to public and stakeholder feedback. Figure 5-1 through Figure shows the recommended weekday system map for the “Yellow” and “Blue” service day schedules. The “Yellow” schedule operates Monday through Friday during the KU Fall/Spring Semester. The “Blue” schedule operates during the KU Summer Semester and KU class breaks.

The final recommended scenario is more similar to the existing Lawrence transit network than either of the initial two service redesign scenarios. This reflects the public preference for the existing network, compared to Scenario I and II, as expressed in surveys following the October 2016 public meetings. Nevertheless, the final recommended scenario does include several design features meant to address the service improvement opportunities identified earlier in the study:

- Restructuring of Route 7 to provide a direct connection between a high concentration of apartments along Haskell Avenue and both downtown Lawrence and south Lawrence retail destinations,
- Consolidating Routes 4 and 6 to provide a direct connection between North Lawrence and 6th Street retail destinations,
- Splitting Route 3 into two new bi-directional routes serving key destinations in northern Lawrence (including Lawrence Memorial Hospital), downtown, and the 9th Street corridor,
- Developing weekday and weekend variants of Route 29 to better match service with demand that varies by day of the week,
- Eliminating Route 9 due to low ridership and poor transit potential,
- Streamlining east Lawrence service (including Routes 1, 7, and 15) to provide more convenient access between downtown Lawrence and east Lawrence destinations,
- Simplifying KU-focused routes to reduce unproductive service and position system for completion of Central District,
- Introducing an evening KU circulator in place of extended hours on the 40-series routes.

Evening, weekend, and holiday (when operating) service maps are show in Figure 5-2 and Figure 5-4. Following the system maps is a detailed overview of each proposed route. For each route, a general description of the service design is provided, as well as a recommended service map, proposed schedules, and a list of major destinations served.

LAWRENCE TRANSIT COA | FINAL REPORT
Lawrence-Douglas County MPO

Figure 5-1 | Recommended "Yellow" Service Day Daytime System Map

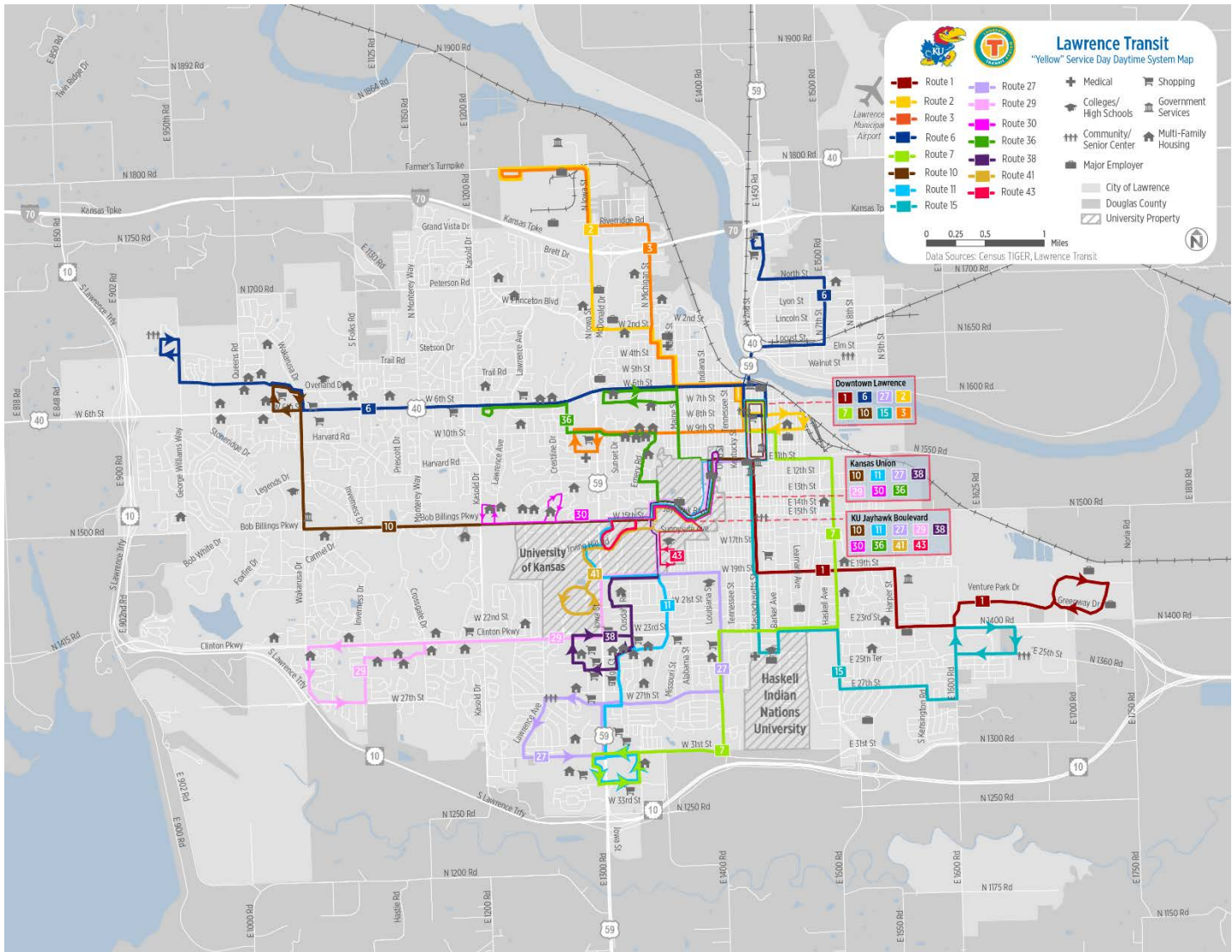

LAWRENCE TRANSIT COA | SERVICE RECOMMENDATIONS
Lawrence-Douglas County MPO

Figure 5-2 | Recommended "Yellow" Service Day Evening (7:00 PM-11:00 PM) System Map

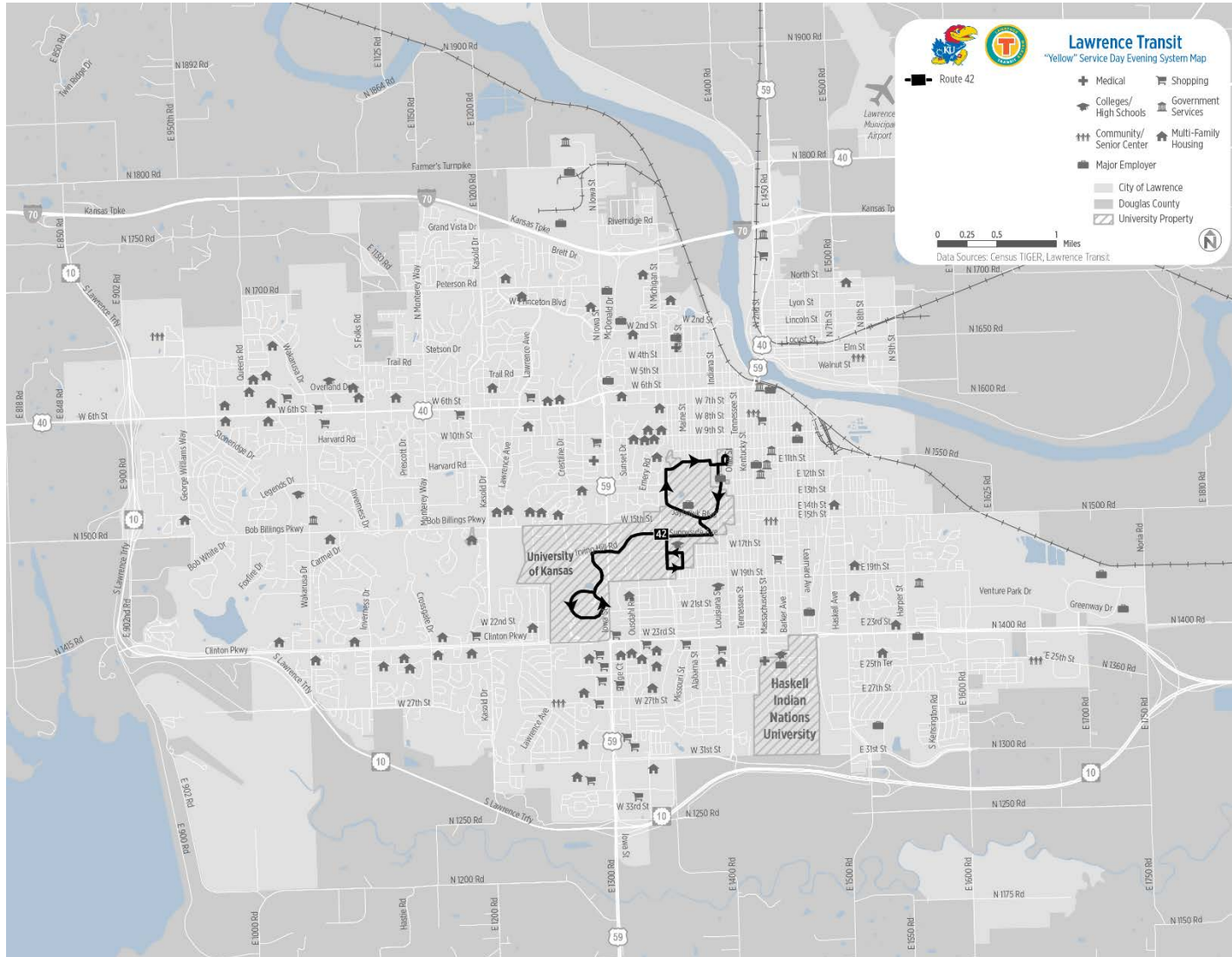

LAWRENCE TRANSIT COA | FINAL REPORT
Lawrence-Douglas County MPO

Figure 5-3 | Recommended "Blue" Service Day System Map

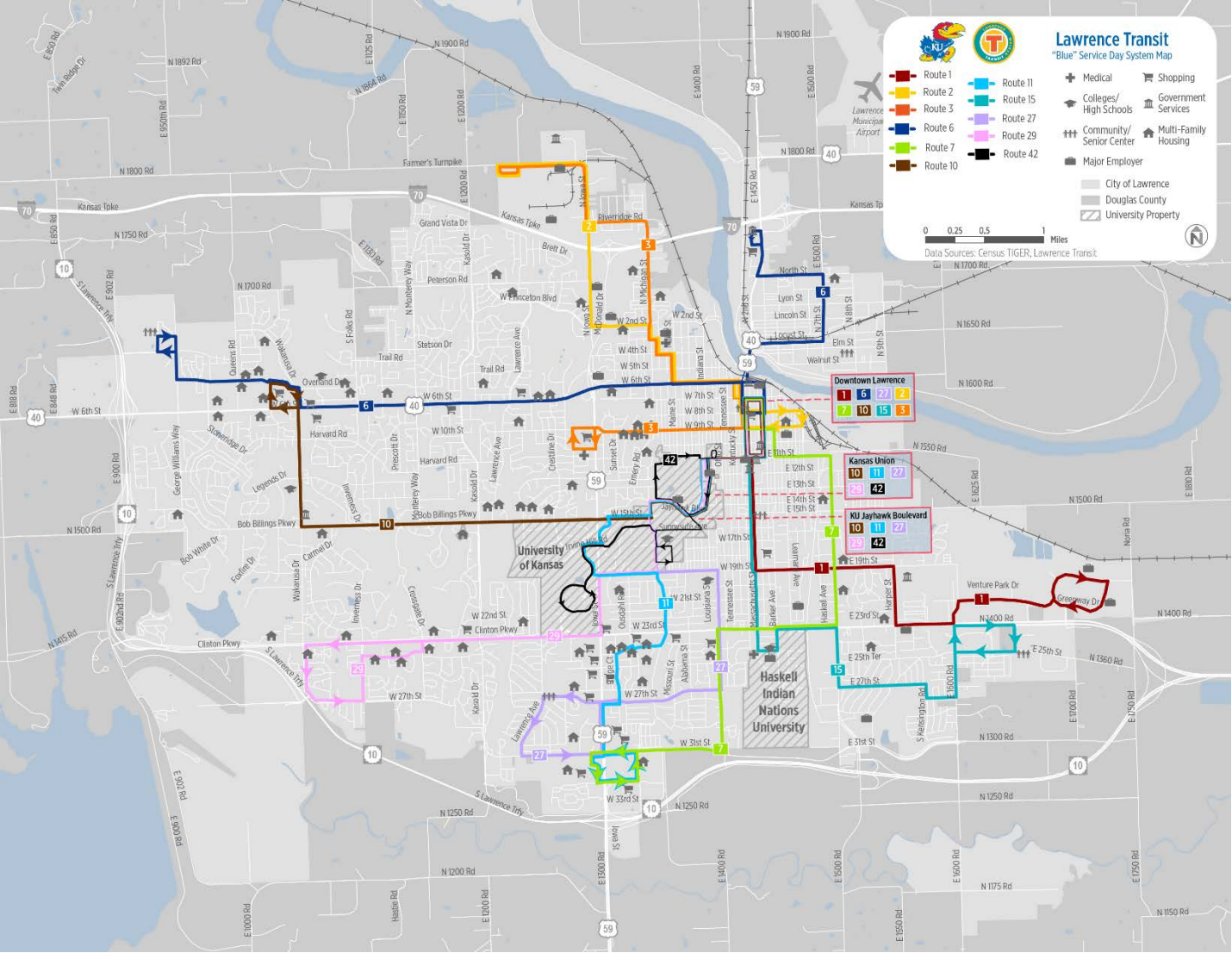

LAWRENCE TRANSIT COA | SERVICE RECOMMENDATIONS

Lawrence-Douglas County MPO

Figure 5-4 | Recommended "Green" Service Day System Map

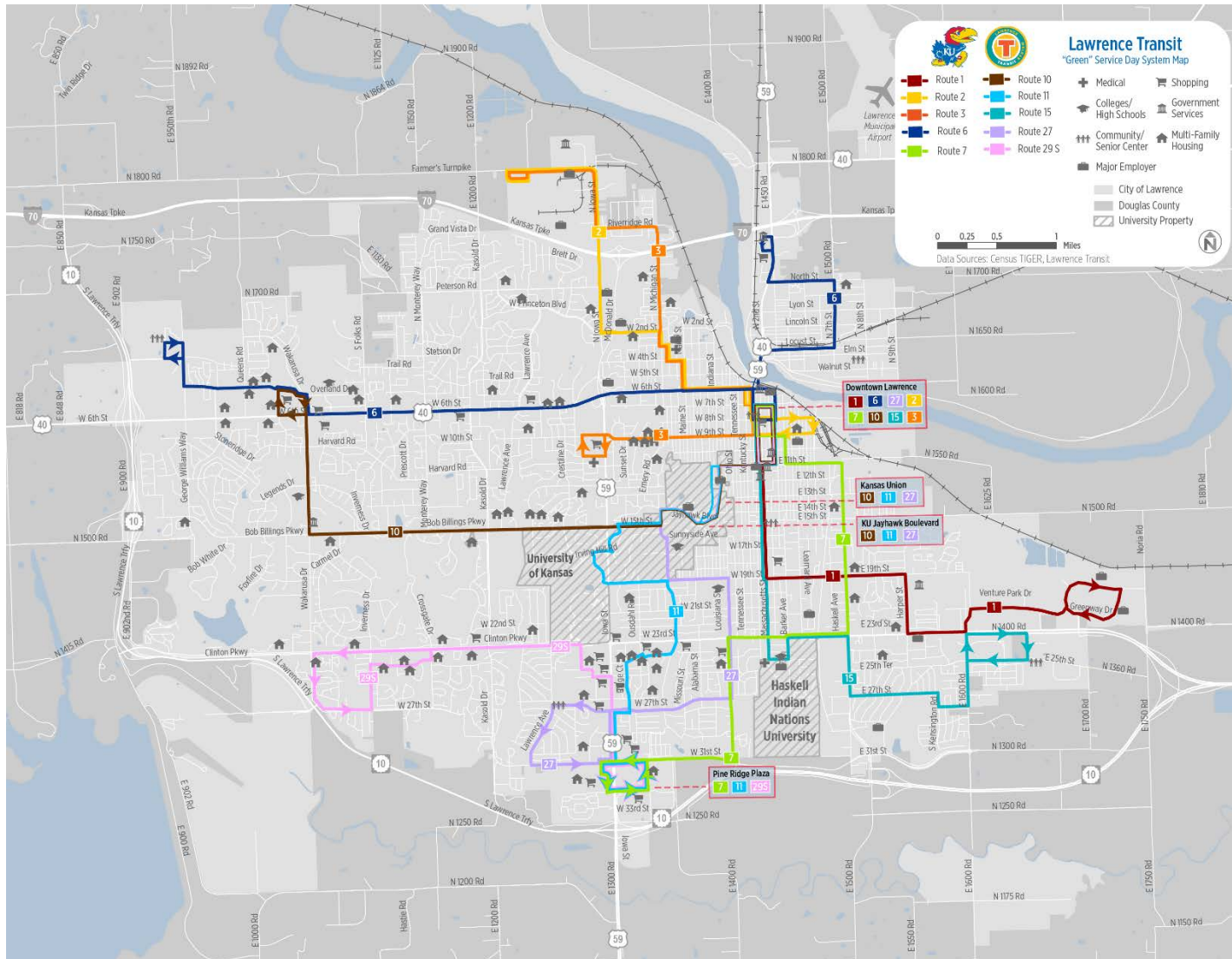

Route 1 – Downtown / East Hills Business Park

Lawrence Transit Route

The proposed Route 1 would operate between downtown Lawrence and the East Hills Business Park. In downtown Lawrence, buses would operate northbound along Vermont Street and southbound along New Hampshire Street.

In addition to providing job-access opportunities at the East Hills Business Park, the proposed route improves access to groceries for residents of apartment complexes and mobile home parks near Harper Street, by providing direct service to Dillons supermarket on Massachusetts Street.

Figure 5-5 | Proposed Future Route 1

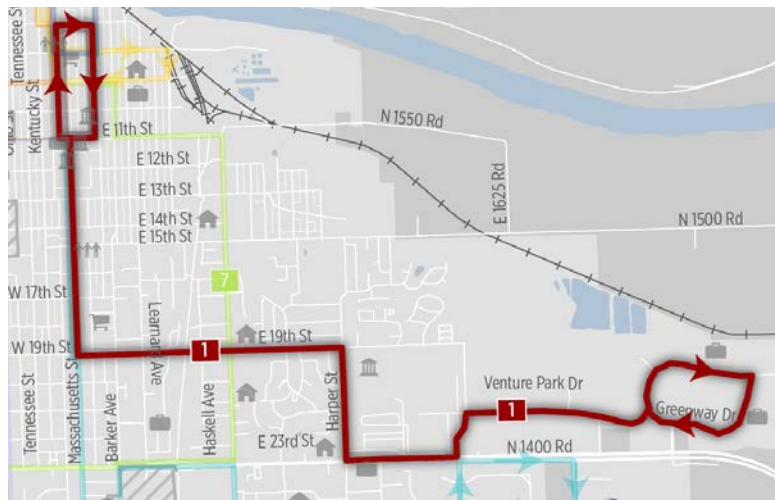

If schedules are off-set with the proposed Route 15, Route 1 would help provide 15-minute service frequency along Massachusetts Street, between 19th Street and downtown Lawrence. Saturday service would begin in the 8:00-hour to address the generally low ridership on Saturdays before 8:00 AM on current Lawrence Transit routes.

The proposed alignment would facilitate multiple transfer opportunities in downtown Lawrence (Vermont and 7th Street), as well as at 9th Street (Routes 2 and 3); 11th Street (Routes 7, 10, 15, and 27); 19th Street (Routes 5 and 7); 23rd Street (Routes 5 and 15); and at the East Hills Business Park (Route 5).

Key destinations along the proposed alignment include:

- East Hills Business Park
- Dillons Supermarket
- Central Middle School
- Douglas County Judicial and Law Enforcement Center
- Downtown Lawrence

| | "Yellow" Service Day | | "Blue" Service Day | | "Green" Service Day | |
|---------------|----------------------|---------------------|--------------------|---------------------|---------------------|---------------------|
| | Span of Service | Frequency (Minutes) | Span of Service | Frequency (Minutes) | Span of Service | Frequency (Minutes) |
| Early Morning | 6:00 AM – 7:00 AM | 30 | 6:00 AM – 7:00 AM | 30 | 6:00 AM – 8:00 AM | - |
| AM Peak | 7:00 AM – 9:30 AM | 30 | 7:00 AM – 9:30 AM | 30 | 8:00 AM – 9:30 AM | 60 |
| Midday | 9:30 AM – 4:00 PM | 30 | 9:30 AM – 4:00 PM | 30 | 9:30 AM – 4:00 PM | 60 |
| PM Peak | 4:00 PM – 6:30 PM | 30 | 4:00 PM – 6:30 PM | 30 | 4:00 PM – 6:30 PM | 60 |
| Evening | 6:30 PM – 8:00 PM | 30 | 6:30 PM – 8:00 PM | 30 | 6:30 PM – 8:00 PM | 60 |

Route 2 – Lakeview Road / Warehouse Arts District via Downtown Lawrence

Lawrence Transit Route

The proposed Route 2 would operate between the Lawrence Paper Company facility on Lakeview Road and the Warehouse Arts District on East 9th Street, via downtown Lawrence. The East 9th Street corridor is anchored by new high-density residential projects at Delaware Street and New Hampshire Street. This type of land-use is generally conducive to transit service. However, the ongoing 9th Street Corridor Project, which aims to transform East 9th Street into a more pedestrian and bicycle-friendly corridor does not currently include provisions for bus service along 9th Street. If the 9th Street Corridor Project ultimately designates East 9th Street as a transit-supportive corridor, the proposed Route 2 could be modified to operate bi-directionally along East 9th Street, with a possible turn-around loop of Pennsylvania Street, 8th Street, and Delaware Street. If East 9th Street cannot accommodate transit service, Route 2 could be shifted to 7th and 8th Street instead.

Figure 5-6 | Proposed Future Route 2

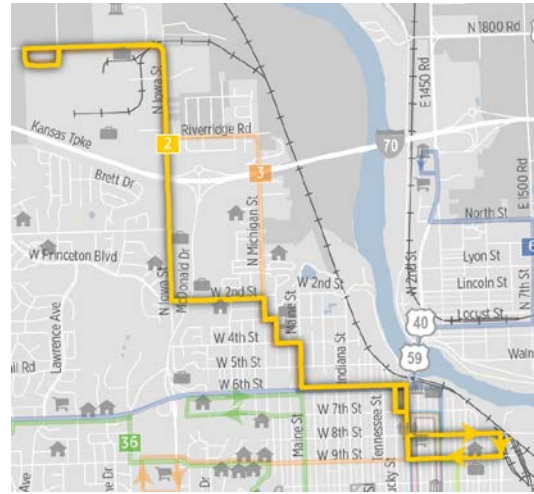

If schedules are off-set with the proposed Route 3, Route 2 would help provide 30-minute service frequency between downtown Lawrence and Lawrence Memorial Hospital, where the two routes overlap. For marketing purposes, East Lawrence service could be operated under a separate route number, with buses changing destination signs in downtown Lawrence. Saturday service would begin in the 8:00-hour to address the generally low ridership on Saturdays before 8:00 AM on current Lawrence Transit routes.

The proposed alignment would facilitate multiple transfer opportunities in downtown Lawrence (Vermont and 7th Street), as well as at 2nd Street (Route 3); Riverridge Road (Route 3); 6th Street (Routes 6 and 36); and East 9th Street (Routes 1, 3, 10, 15 and 27).

Key destinations along the proposed alignment include:

- Lakeview Road Industrial Employers
- Hallmark Cards Production Center
- Lawrence Memorial Hospital
- Downtown Lawrence
- Warehouse Arts District

| | "Yellow" Service Day | | "Blue" Service Day | | "Green" Service Day | |
|---------------|----------------------|---------------------|--------------------|---------------------|---------------------|---------------------|
| | Span of Service | Frequency (Minutes) | Span of Service | Frequency (Minutes) | Span of Service | Frequency (Minutes) |
| Early Morning | 6:00 AM – 7:00 AM | 60 | 6:00 AM – 7:00 AM | 60 | 6:00 AM – 8:00 AM | - |
| AM Peak | 7:00 AM – 9:30 AM | 60 | 7:00 AM – 9:30 AM | 60 | 8:00 AM – 9:30 AM | 60 |
| Midday | 9:30 AM – 4:00 PM | 60 | 9:30 AM – 4:00 PM | 60 | 9:30 AM – 4:00 PM | 60 |
| PM Peak | 4:00 PM – 6:30 PM | 60 | 4:00 PM – 6:30 PM | 60 | 4:00 PM – 6:30 PM | 60 |
| Evening | 6:30 PM – 8:00 PM | 60 | 6:30 PM – 8:00 PM | 60 | 6:30 PM – 8:00 PM | 60 |

Route 3 – Lakeview Road / 9th & Iowa via Downtown Lawrence

Lawrence Transit Route

The proposed Route 3 would operate between the Lawrence Paper Company facility on Lakeview Road and the Hillcrest shopping center at 9th and Iowa Street, via downtown Lawrence.

The proposed alignment would provide more direct bi-directional service for residents of apartment complexes and mobile home parks along North Michigan Street, compared to the southbound-only service offered today. If schedules are off-set with the proposed Route 2, Route 3 would help provide 30-minute service frequency between downtown Lawrence and Lawrence Memorial Hospital, where the two routes overlap. Saturday service would begin in the 8:00-hour to address the generally low ridership on Saturdays before 8:00 AM on current Lawrence Transit routes.

The West 9th Street segment of the proposed route could also be presented as a separate route number, rather than a continuation of Route 3. Under this scenario, buses operating on Route 3 would change their destination signs at 7th and Vermont Street before and after serving West 9th Street. However, for the purpose of this document, the West 9th Street service is included as part of Route 3.

The proposed alignment would facilitate multiple transfer opportunities in downtown Lawrence (Vermont and 7th Street), as well as at 2nd Street (Route 3); Riverridge Road (Route 3); 6th Street (Routes 6 and 36); and West 9th Street (Routes 1, 2, 10, 15, 27, and 36).

Key destinations along the proposed alignment include:

- Lawrence Road Industrial Employers
- Multiple apartments near North Michigan Street
- Lawrence Memorial Hospital
- Downtown Lawrence
- The Merc Co-op

Figure 5-7 | Proposed Future Route 3

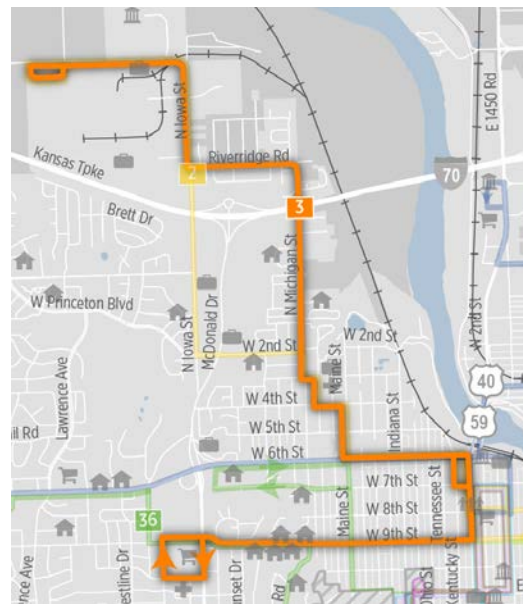

| | "Yellow" Service Day | | "Blue" Service Day | | "Green" Service Day | |
|---------------|----------------------|---------------------|--------------------|---------------------|---------------------|---------------------|
| | Span of Service | Frequency (Minutes) | Span of Service | Frequency (Minutes) | Span of Service | Frequency (Minutes) |
| Early Morning | 6:00 AM – 7:00 AM | 60 | 6:00 AM – 7:00 AM | 60 | 6:00 AM – 8:00 AM | - |
| AM Peak | 7:00 AM – 9:30 AM | 60 | 7:00 AM – 9:30 AM | 60 | 8:00 AM – 9:30 AM | 60 |
| Midday | 9:30 AM – 4:00 PM | 60 | 9:30 AM – 4:00 PM | 60 | 9:30 AM – 4:00 PM | 60 |
| PM Peak | 4:00 PM – 6:30 PM | 60 | 4:00 PM – 6:30 PM | 60 | 4:00 PM – 6:30 PM | 60 |
| Evening | 6:30 PM – 8:00 PM | 60 | 6:30 PM – 8:00 PM | 60 | 6:30 PM – 8:00 PM | 60 |

Route 6 – North Lawrence / Rock Chalk Park via Downtown Lawrence

Lawrence Transit Route

The proposed Route 6 would operate between the Department of Motor Vehicles office in North Lawrence and Rock Chalk Park, via downtown Lawrence and 6th Street. The route would

significantly improve access to grocery and retail destinations, including Walmart, for North Lawrence residents, by eliminating a transfer in downtown Lawrence.

Figure 5-8 | Proposed Future Route 6

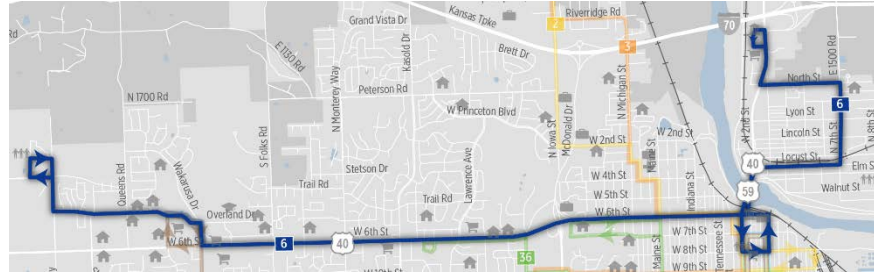

North Lawrence currently has no full-service grocery stores. Presently, residents can either access the Merc Co-op directly via Route 4, or Walmart and several supermarkets along 6th Street via a transfer to Route 6. The Merc is a specialty grocery store with higher prices and a more limited selection than what can be found at other stores on 6th Street. However, traveling to and from 6th Street requires a transfer in downtown Lawrence which is an extra burden for North Lawrence residents, especially when traveling with shopping bags. In addition, 6th Street is an important employment corridor and providing direct access to this corridor improves job-access opportunities for North Lawrence residents.

Saturday service would begin in the 8:00-hour to address the generally low ridership on Saturdays before 8:00 AM on current Lawrence Transit routes.

The proposed alignment would facilitate multiple transfer opportunities in downtown Lawrence (Vermont and 7th Street), as well as at Maine Street (Routes 2, 3, and 36) and Overland Drive (Route 10).

Key destinations along the proposed alignment include:

- Department of Motor Vehicles Office
- Downtown Lawrence
- Dillons Supermarket (Lawrence Avenue)
- Hy-Vee Supermarket
- Sprouts Farmers Market
- Dillons Supermarket (Wakarusa Drive)
- Free State High School
- Walmart
- Rock Chalk Park

| | "Yellow" Service Day | | "Blue" Service Day | | "Green" Service Day | |
|---------------|----------------------|---------------------|--------------------|---------------------|---------------------|---------------------|
| | Span of Service | Frequency (Minutes) | Span of Service | Frequency (Minutes) | Span of Service | Frequency (Minutes) |
| Early Morning | 6:00 AM – 7:00 AM | 30 | 6:00 AM – 7:00 AM | 30 | 6:00 AM – 8:00 AM | - |
| AM Peak | 7:00 AM – 9:30 AM | 30 | 7:00 AM – 9:30 AM | 30 | 8:00 AM – 9:30 AM | 30 |
| Midday | 9:30 AM – 4:00 PM | 30 | 9:30 AM – 4:00 PM | 30 | 9:30 AM – 4:00 PM | 30 |
| PM Peak | 4:00 PM – 6:30 PM | 30 | 4:00 PM – 6:30 PM | 30 | 4:00 PM – 6:30 PM | 30 |
| Evening | 6:30 PM – 8:00 PM | 30 | 6:30 PM – 8:00 PM | 30 | 6:30 PM – 8:00 PM | 30 |

Route 7 – Downtown / 33rd & Iowa

Lawrence Transit Route

The proposed Route 7 would operate between downtown Lawrence and Walmart on Iowa Street. North of 9th Street, buses would operate northbound along Vermont Street and southbound along New Hampshire Street.

The proposed alignment would significantly improve access to retail and grocery destinations for residents of several large apartment communities along the Haskell Avenue corridor. Currently, the closest grocery store to this corridor is Dillons on Massachusetts and 19th Street, but there is no transit link between Haskell Avenue and the Dillons.

The proposed Route 7 would overlap with the proposed Route 27 for several blocks of Louisiana Street. Passengers would be able to transfer between the two routes at common stops for service to downtown Lawrence or the University of Kansas. In addition, the proposed alignment would facilitate multiple transfer opportunities in downtown Lawrence (Vermont and 7th Street), as well as at 9th Street (Routes 2 and 3); 11th Street (Routes 1, 10, 15, and 27); 19th Street (Route 1); 23rd Street (Route 15); and 31st Street (Routes 11 and 27).

Saturday service would begin in the 8:00-hour to address the generally low ridership on Saturdays before 8:00 AM on current Lawrence Transit routes.

Key destinations along the proposed alignment include:

- Target
- Walmart
- Checkers Foods
- Haskell Indian Nations University
- Lawrence-Douglas County Housing Authority
- Douglas County Judicial and Law Enforcement Center
- East Lawrence Recreation Center
- Downtown Lawrence

Figure 5-9 | Proposed Future Route 7

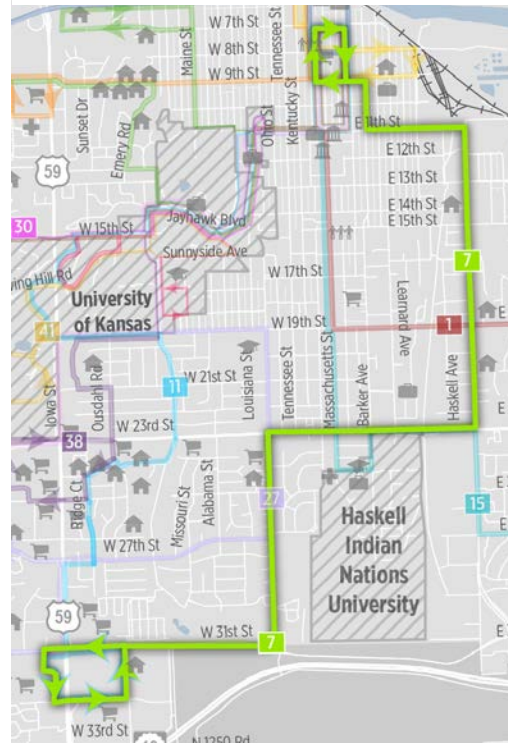

| | "Yellow" Service Day | | "Blue" Service Day | | "Green" Service Day | |
|---------------|----------------------|---------------------|--------------------|---------------------|---------------------|---------------------|
| | Span of Service | Frequency (Minutes) | Span of Service | Frequency (Minutes) | Span of Service | Frequency (Minutes) |
| Early Morning | 6:00 AM – 7:00 AM | 30 | 6:00 AM – 7:00 AM | 30 | 6:00 AM – 8:00 AM | - |
| AM Peak | 7:00 AM – 9:30 AM | 30 | 7:00 AM – 9:30 AM | 30 | 8:00 AM – 9:30 AM | 30 |
| Midday | 9:30 AM – 4:00 PM | 30 | 9:30 AM – 4:00 PM | 30 | 9:30 AM – 4:00 PM | 30 |
| PM Peak | 4:00 PM – 6:30 PM | 30 | 4:00 PM – 6:30 PM | 30 | 4:00 PM – 6:30 PM | 30 |
| Evening | 6:30 PM – 8:00 PM | 30 | 6:30 PM – 8:00 PM | 30 | 6:30 PM – 8:00 PM | 30 |

Route 10 – Downtown / 6th & Wakarusa via KU

Lawrence Transit Route

The proposed Route 10 would operate between downtown Lawrence and Walmart at 6th and Wakarusa via the University of Kansas. The proposed alignment is similar to the

Figure 5-10 | Proposed Future Route 10

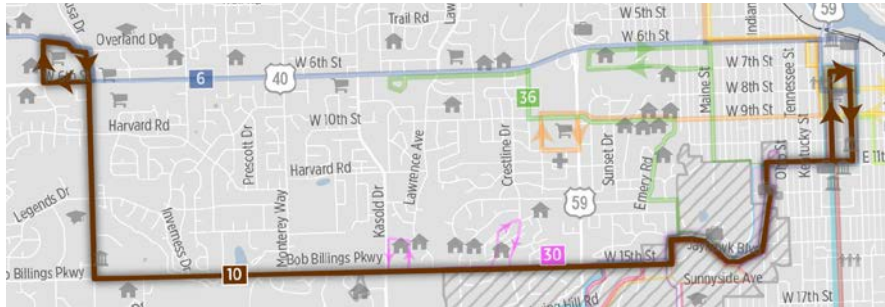

current Route 10, with the exception of service through downtown, which would operate northbound on Vermont Street and southbound on New Hampshire.

As a stand-alone route, the proposed alignment would allow for a one-hour cycle time, but with very little recovery. Consequently, the route would be prone to poor on-time performance. Interlining the route with the proposed Route 27, which also serves downtown Lawrence, would result in enough recovery time to not only ensure on-time performance, but also to extend the route to Rock Chalk Park. While Rock Chalk Park alone may not justify the additional service, the area between it and Wakarusa Drive is undergoing a transformation into a high-density neighborhood with numerous new apartment complexes. Additionally, extending Route 10 to Rock Chalk Park would improve access to the athletic facilities for Lawrence High School students and other residents of south and west Lawrence who could connect to the route at KU.

The proposed alignment would facilitate transfer opportunities in downtown Lawrence (Vermont and 7th Street) and at KU (Jayhawk Boulevard and the Kansas Union), Wakarusa Drive (Route 6), Kasold Drive (Route 30), 11th Street (Routes 1, 7, 15, and 27), and 9th Street (Routes 2 and 3).

Saturday service would begin in the 8:00-hour to address the generally low ridership on Saturdays before 8:00 AM on current Lawrence Transit routes.

Key destinations along the proposed alignment include:

- Walmart
- Free State High School
- Dillons Supermarket
- Social Security Administration Office
- The University of Kansas
- Douglas County Judicial and Law Enforcement Center
- Downtown Lawrence

| | "Yellow" Service Day | | "Blue" Service Day | | "Green" Service Day | |
|---------------|----------------------|---------------------|--------------------|---------------------|---------------------|---------------------|
| | Span of Service | Frequency (Minutes) | Span of Service | Frequency (Minutes) | Span of Service | Frequency (Minutes) |
| Early Morning | 6:00 AM – 7:00 AM | 30 | 6:00 AM – 7:00 AM | 30 | 6:00 AM – 8:00 AM | - |
| AM Peak | 7:00 AM – 9:30 AM | 30 | 7:00 AM – 9:30 AM | 30 | 8:00 AM – 9:30 AM | 30 |
| Midday | 9:30 AM – 4:00 PM | 30 | 9:30 AM – 4:00 PM | 30 | 9:30 AM – 4:00 PM | 30 |
| PM Peak | 4:00 PM – 6:30 PM | 30 | 4:00 PM – 6:30 PM | 30 | 4:00 PM – 6:30 PM | 30 |
| Evening | 6:30 PM – 8:00 PM | 30 | 6:30 PM – 8:00 PM | 30 | 6:30 PM – 8:00 PM | 30 |

Route 11 – KU / 33rd & Iowa

Coordinated Route

The proposed Route 11 would operate between the University of Kansas and Walmart on Iowa Street. The route is similar to the current Route 11 alignment, with two notable exceptions: On the north end of the route, service would end at KU rather than downtown Lawrence. The route would terminate with a one-way loop consisting of Mississippi Street, 11th Street, Indiana Street, and Oread Avenue / Jayhawk Boulevard.

On the south end of the route, service would end at Walmart rather than The Reserve apartments. Passengers traveling to downtown Lawrence could transfer to proposed Routes 10 or 27 at the Kansas Union (as well as other locations) or take proposed Routes 7 or 27 to downtown from the Iowa Street corridor. The proposed Route 27 would also serve The Reserve apartments.

The proposed alignment would facilitate multiple transfer opportunities at KU (Jayhawk Boulevard and the Kansas Union), as well as 19th Street (Routes 27, 29, and 38); 23rd Street (Route 38); 27th Street (Route 27); and 33rd Street (Route 7).

Saturday service would begin in the 8:00-hour to address the generally low ridership on Saturdays before 8:00 AM on current Lawrence Transit routes.

Key destinations along the proposed alignment include:

- Target
- Walmart
- Aldi Grocery Store
- The United Way
- Rockland East Apartments
- Dillons Supermarket
- The University of Kansas

Figure 5-11 | Proposed Future Route 11

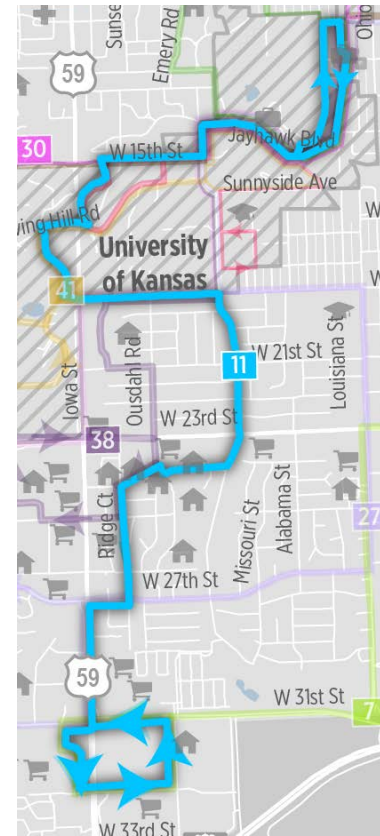

| | "Yellow" Service Day | | "Blue" Service Day | | "Green" Service Day | |
|---------------|----------------------|---------------------|--------------------|---------------------|---------------------|---------------------|
| | Span of Service | Frequency (Minutes) | Span of Service | Frequency (Minutes) | Span of Service | Frequency (Minutes) |
| Early Morning | 6:00 AM – 7:00 AM | - | 6:00 AM – 7:00 AM | - | 6:00 AM – 8:00 AM | - |
| AM Peak | 7:00 AM – 9:30 AM | 20 | 7:00 AM – 9:30 AM | 60 | 8:00 AM – 9:30 AM | 30 |
| Midday | 9:30 AM – 4:00 PM | 30 | 9:30 AM – 4:00 PM | 60 | 9:30 AM – 4:00 PM | 30 |
| PM Peak | 4:00 PM – 6:30 PM | 20 | 4:00 PM – 6:30 PM | 60 | 4:00 PM – 6:30 PM | 30 |
| Evening | 6:30 PM – 8:00 PM | 30 | 6:30 PM – 8:00 PM | 60 | 6:30 PM – 8:00 PM | 30 |

Route 15 – Downtown / Franklin & 25th

Lawrence Transit Route

The proposed Route 15 would operate between downtown Lawrence, and the Douglas County Jail and Lawrence Community Shelter on 25th Street, near Franklin Road. In downtown Lawrence, buses would operate northbound along Vermont Street and southbound along New Hampshire Street.

Compared to the current Route 15, the proposed alignment is more streamlined and direct. Rather than operating along Connecticut Street, where ridership is extremely low, service is shifted to Massachusetts Street where there is a Dillons and ridership is much higher. If schedules are off-set with the proposed Route 1, Route 15 would help provide 15-minute service frequency along Massachusetts Street, between 19th Street

and downtown Lawrence. Saturday service would begin in the 8:00-hour to address the generally low ridership on Saturdays before 8:00 AM on current Lawrence Transit routes.

Shifting the Route 15 alignment to Massachusetts Street also puts the route in position to efficiently serve Haskell Indian Nations University and link the school directly to downtown Lawrence. From HINU, the proposed route would continue east through the Prairie Park neighborhood, but would not directly service the Peaslee Center. The Peaslee Center is not currently a strong ridership generator, but would remain within three blocks of Route 15 under the proposed alignment. The East Hills Business Park, the current terminus for Route 15, would instead be served from downtown by proposed Routes 1.

The proposed alignment would facilitate multiple transfer opportunities in downtown Lawrence (Vermont and 7th Street), as well as at 9th Street (Routes 2, 3, and 7); 11th Street (Routes 1, 10, and 27); 19th Street (Route 1); 23rd Street (Route 7); and Haskell Avenue (Route 7).

Figure 5-12 | Proposed Future Route 15

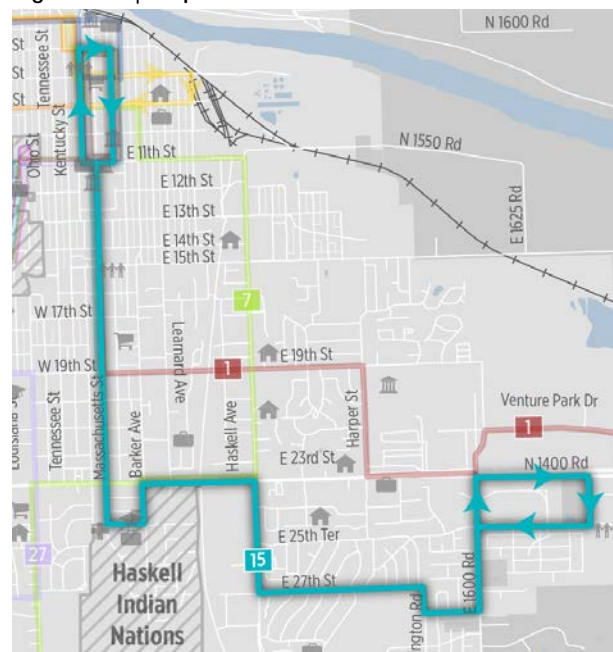

| | "Yellow" Service Day | | "Blue" Service Day | | "Green" Service Day | |
|---------------|----------------------|---------------------|--------------------|---------------------|---------------------|---------------------|
| | Span of Service | Frequency (Minutes) | Span of Service | Frequency (Minutes) | Span of Service | Frequency (Minutes) |
| Early Morning | 6:00 AM – 7:00 AM | 30 | 6:00 AM – 7:00 AM | 30 | 6:00 AM – 8:00 AM | - |
| AM Peak | 7:00 AM – 9:30 AM | 30 | 7:00 AM – 9:30 AM | 30 | 8:00 AM – 9:30 AM | 30 |
| Midday | 9:30 AM – 4:00 PM | 30 | 9:30 AM – 4:00 PM | 30 | 9:30 AM – 4:00 PM | 30 |
| PM Peak | 4:00 PM – 6:30 PM | 30 | 4:00 PM – 6:30 PM | 30 | 4:00 PM – 6:30 PM | 30 |
| Evening | 6:30 PM – 8:00 PM | 30 | 6:30 PM – 8:00 PM | 30 | 6:30 PM – 8:00 PM | 30 |

Key destinations along the proposed alignment include:

- Douglas County Jail
- Lawrence Community Shelter
- Haskell Indian Nations University
- Dillons Supermarket
- Central Middle School
- Douglas County Judicial and Law Enforcement Center

Route 27 – Downtown / 31st & Iowa via KU

Lawrence Transit Route

The proposed Route 27 would operate between downtown Lawrence, and the intersection of 31st Street and Iowa Street, via the University of Kansas. It would also serve the Holcomb Park Recreation Center and The Reserve apartment complex on 31st Street.

In downtown Lawrence, buses would operate northbound along Vermont Street and southbound along New Hampshire Street. The southern end of the route would consist of a counter-clockwise loop along 27th Street, Lawrence Avenue, 31st Street, and Iowa Street. One-way loops are generally not the ideal service design, but in this case, one-way service along 31st Street has several benefits. Riders from both Cottonwood, Inc. and The Reserve would be able to begin and end their trips on Route 27 without having to cross 31st Street. In addition, Route 27 buses would not need to enter The Reserve property in order to provide safe and convenient access to riders.

Figure 5-13 | Proposed Future Route 27

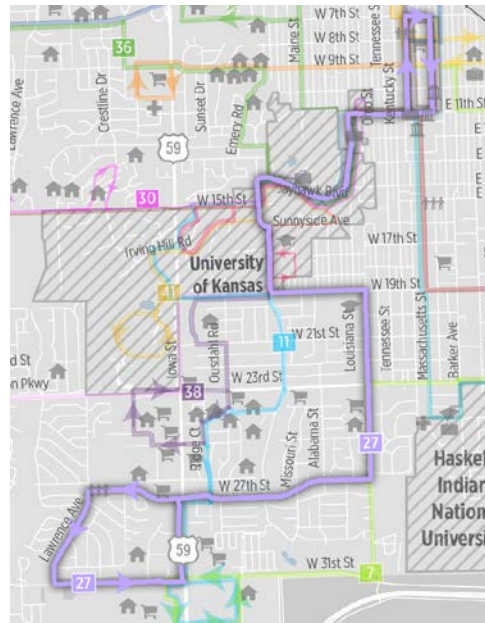

If schedules are off-set with the proposed Route 10, Route 27 would help provide 15-minute service frequency between KU and downtown Lawrence. Saturday service would begin in the 8:00-hour to address the generally low ridership on Saturdays before 8:00 AM on current Lawrence Transit routes. The proposed alignment would facilitate multiple transfer opportunities in downtown Lawrence (Vermont and 7th Street) and at KU (Jayhawk Boulevard and the Kansas Union), as well as at 9th Street (Routes 2 and 3); 11th Street (Routes 1, 10, and 15); 19th Street (Routes 11, 29, and 38); 23rd Street (Route 7); Ridge Court (Route 11); and Iowa Street (Routes 7 and 11).

Key destinations along the proposed alignment include:

- Target
- The Reserve Apartments
- Cottonwood, Inc.
- Holcomb Park Recreation Center
- Checkers Foods
- Lawrence High School
- The University of Kansas
- Douglas County Judicial and Law Enforcement Center
- Downtown Lawrence

| | "Yellow" Service Day | | "Blue" Service Day | | "Green" Service Day | |
|---------------|----------------------|---------------------|--------------------|---------------------|---------------------|---------------------|
| | Span of Service | Frequency (Minutes) | Span of Service | Frequency (Minutes) | Span of Service | Frequency (Minutes) |
| Early Morning | 6:00 AM – 7:00 AM | 30 | 6:00 AM – 7:00 AM | 30 | 6:00 AM – 8:00 AM | - |
| AM Peak | 7:00 AM – 9:30 AM | 30 | 7:00 AM – 9:30 AM | 30 | 8:00 AM – 9:30 AM | 30 |
| Midday | 9:30 AM – 4:00 PM | 30 | 9:30 AM – 4:00 PM | 30 | 9:30 AM – 4:00 PM | 30 |
| PM Peak | 4:00 PM – 6:30 PM | 30 | 4:00 PM – 6:30 PM | 30 | 4:00 PM – 6:30 PM | 30 |
| Evening | 6:30 PM – 8:00 PM | 30 | 6:30 PM – 8:00 PM | 30 | 6:30 PM – 8:00 PM | 30 |

Route 29 – 27th & Wakarusa / KU

Coordinated Route

The proposed Route 29 would operate between the University of Kansas and the intersection of 27th Street and Wakarusa Drive in southwest Lawrence. The route is similar to the current Route 29 alignment, but would access the KU campus from the south rather than from the west. Service would be shifted from Iowa Street and 15th Street to 19th Street and Naismith Drive. This alignment would remove service from a segment of Iowa Street that has little transit potential due to several land-use and roadway design factors (long blocks with few crosswalks; deep setbacks and grade-separations of adjacent buildings; right turn lanes precluding curb access at intersections). Instead, Route 29 would serve the Chase Court Apartments on Stewart Street and also provide improved access to the Ambler Student Recreation and Fitness Center for students living off-campus.

Figure 5-14 | Proposed Future Route 29

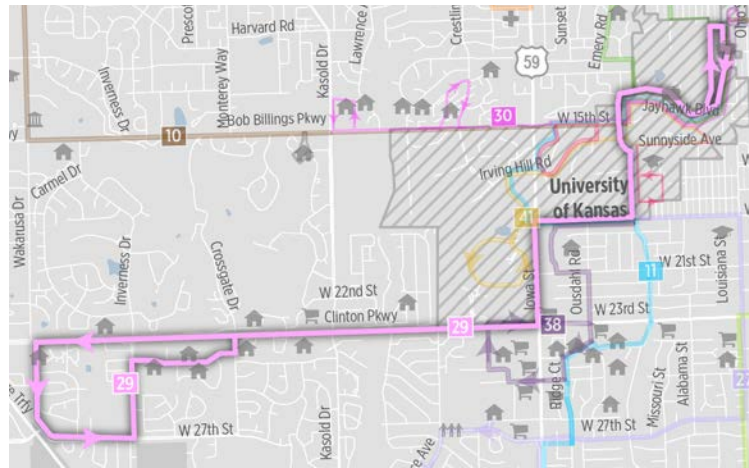

The proposed alignment would not add significant time to Route 29, especially for students with destinations on the south end of campus, including future destinations in the Central District. An analysis of ridership data collected as part of this study shows that only one weekday trip had a passenger load of more than 40 people (the seating capacity of a typical 40-foot transit vehicle). Thus, capacity does exist to absorb additional passengers from the Chase Court Apartments. However, the demand for transit service along 19th Street will likely fall with the completion of the Central District and Jayhawk Trail, which will provide a more pedestrian and bicycle-friendly environment than currently exists on the south end of campus. The proposed alignment would facilitate multiple transfer opportunities at KU (Jayhawk Boulevard and the Kansas Union), as well as at 19th Street (Routes 11 and 38).

Key destinations along the proposed alignment include:

- Southwest Middle School
- Multiple Apartments near Clinton Parkway
- Hy-Vee Supermarket
- Chase Court Apartments
- The University of Kansas

| | "Yellow" Service Day | | "Blue" Service Day | | "Green" Service Day | |
|---------------|----------------------|---------------------|--------------------|---------------------|---------------------|---------------------|
| | Span of Service | Frequency (Minutes) | Span of Service | Frequency (Minutes) | Span of Service | Frequency (Minutes) |
| Early Morning | 6:00 AM – 7:00 AM | - | 6:00 AM – 7:00 AM | - | 6:00 AM – 8:00 AM | - |
| AM Peak | 7:00 AM – 9:30 AM | 20 | 7:00 AM – 9:30 AM | 60 | 8:00 AM – 9:30 AM | - |
| Midday | 9:30 AM – 4:00 PM | 30 | 9:30 AM – 4:00 PM | 60 | 9:30 AM – 4:00 PM | - |
| PM Peak | 4:00 PM – 6:30 PM | 20 | 4:00 PM – 6:30 PM | 60 | 4:00 PM – 6:30 PM | - |
| Evening | 6:30 PM – 8:00 PM | 30 | 6:30 PM – 8:00 PM | 60 | 6:30 PM – 8:00 PM | - |

Route 29S – 27th & Wakarusa / 33rd & Iowa

Coordinated Route

The proposed Route 29S is a modified variant of Route 29 that would operate on Saturdays only. The proposed route would operate between the 27th Street and Wakarusa Drive and the Walmart at 33rd and Iowa, via Melrose Lane.

Route 29S would increase access to popular weekend retail

destinations for the residents of multiple apartment complexes along the Clinton Parkway corridor. The proposed route would help replace the current Route 9, which generally has very low ridership, but does see increased use on Saturdays with its connection to retail destinations.

Saturday service would begin in the 8:00-hour to address the generally low ridership on Saturdays before 8:00 AM on current Lawrence Transit routes.

Southwest Lawrence residents wishing to travel to the KU campus on Saturday could still do so with one transfer. The proposed alignment would facilitate multiple transfer opportunities along Iowa Street or 33rd Street (Routes 7, 11, and 27).

Key destinations along the proposed alignment include:

- Multiple Apartments near Clinton Parkway
- Hy-Vee Supermarket
- Aldi Grocery Store
- Target
- Walmart

Figure 5-15 | Proposed Future Route 29S

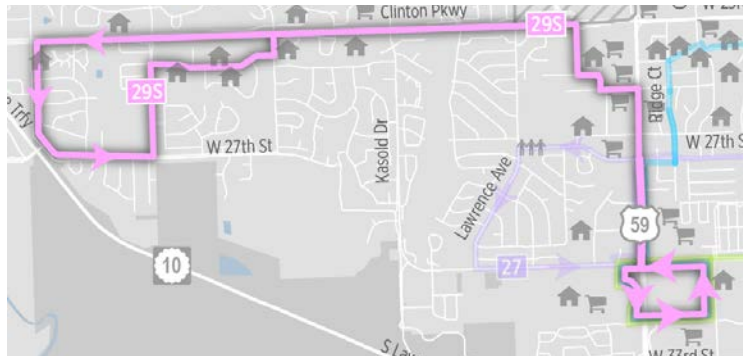

| | "Yellow" Service Day | | "Blue" Service Day | | "Green" Service Day | |
|---------------|----------------------|---------------------|--------------------|---------------------|---------------------|---------------------|
| | Span of Service | Frequency (Minutes) | Span of Service | Frequency (Minutes) | Span of Service | Frequency (Minutes) |
| Early Morning | 6:00 AM – 7:00 AM | - | 6:00 AM – 7:00 AM | - | 6:00 AM – 8:00 AM | - |
| AM Peak | 7:00 AM – 9:30 AM | - | 7:00 AM – 9:30 AM | - | 8:00 AM – 9:30 AM | 30 |
| Midday | 9:30 AM – 4:00 PM | - | 9:30 AM – 4:00 PM | - | 9:30 AM – 4:00 PM | 30 |
| PM Peak | 4:00 PM – 6:30 PM | - | 4:00 PM – 6:30 PM | - | 4:00 PM – 6:30 PM | 30 |
| Evening | 6:30 PM – 8:00 PM | - | 6:30 PM – 8:00 PM | - | 6:30 PM – 8:00 PM | 30 |

Route 30 – Bob Billings & Kasold / KU

KUOW Route

The proposed Route 30 would operate between the University of Kansas, and the intersection of Bob Billings Parkway and Kasold Drive. The route is similar to the current Route 30 alignment, but extends further northeast to serve Corbin Hall and GSP along 11th Street.

Figure 5-16 | Proposed Future Route 30



The proposed alignment would facilitate multiple transfer opportunities at KU (Jayhawk Boulevard and the Kansas Union), as well as along Bob Billings Parkway (Route 10).

Key destinations along the proposed alignment include:

- Orchard Corners Shopping Center
- Multiple Apartments near Bob Billings Parkway
- The University of Kansas

| | "Yellow" Service Day | | "Blue" Service Day | | "Green" Service Day | |
|---------------|----------------------|---------------------|--------------------|---------------------|---------------------|---------------------|
| | Span of Service | Frequency (Minutes) | Span of Service | Frequency (Minutes) | Span of Service | Frequency (Minutes) |
| Early Morning | 7:00 AM – 7:30 AM | 20 | - | - | - | - |
| Daytime | 7:30 AM – 4:30 PM | 20 | - | - | - | - |
| Evening | 4:30 PM – 7:00 PM | 20 | - | - | - | - |

Route 36 – 6th & Gateway / 6th & Iowa via KU

KUOW Route

The proposed Route 36 would operate between the Sunrise Apartments near 6th Street and Gateway Court, and the Highpoint Apartments near 6th Street and Iowa Street, via the University of Kansas. The route is similar to the current Route 36 alignment, but would not serve Michigan Street, north of 6th Street. Michigan Street would instead be served by the proposed Route 3, with transfers

Figure 5-17 | Proposed Future Route 36

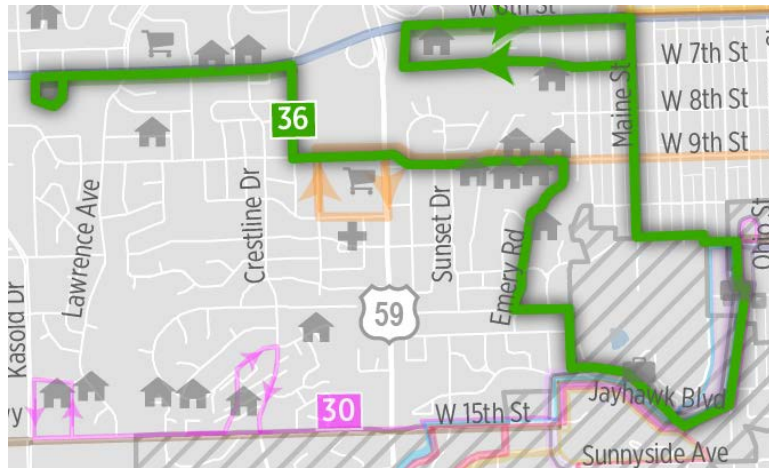

between the two routes available at the intersection of 6th and Maine Street.

To improve access to academic and housing facilities near Fambrough Drive, the proposed Route 36 alignment extends one block west along Fambrough to Maine Street.

The proposed alignment would facilitate multiple transfer opportunities at KU (Jayhawk Boulevard and the Kansas Union), as well as at 6th Street (Routes 2, 3, and 6); and 9th Street (Route 3).

Key destinations along the proposed alignment include:

- Multiple Apartments near 6th Street
- Dillons Supermarket
- The Merc Co-op
- Multiple Apartments near 9th Street
- Greek Houses near Emery Road
- The University of Kansas

| | "Yellow" Service Day | | "Blue" Service Day | | "Green" Service Day | |
|---------------|----------------------|---------------------|--------------------|---------------------|---------------------|---------------------|
| | Span of Service | Frequency (Minutes) | Span of Service | Frequency (Minutes) | Span of Service | Frequency (Minutes) |
| Early Morning | 7:00 AM – 7:30 AM | 30 | - | - | - | - |
| Daytime | 7:30 AM – 4:30 PM | 20 | - | - | - | - |
| Evening | 4:30 PM – 7:00 PM | 30 | - | - | - | - |

Route 38 – Melrose Lane / KU

KUOW Route

The proposed Route 38 would operate between the University of Kansas and Melrose Lane, near Iowa Street and Clinton Parkway.

The route is similar to the current Route 38, but with several notable differences. On the KU campus, the route extends further northeast to serve Corbin Hall and GSP along 11th Street. On its southern end, the route crosses 23rd Street on Ousdahl Road to expand service to apartment communities on the east side of Iowa Street.

The proposed alignment would facilitate multiple transfer opportunities at KU (Jayhawk Boulevard and the Kansas Union), as well as at 19th Street (Routes 11 and 27); Ridge Court (Route 11); and Clinton Parkway (Route 29).

Key destinations along the proposed alignment include:

- Multiple apartments near Clinton Parkway and Iowa Street
- Chase Court Apartments
- The University of Kansas

Figure 5-18 | Proposed Future Route 38

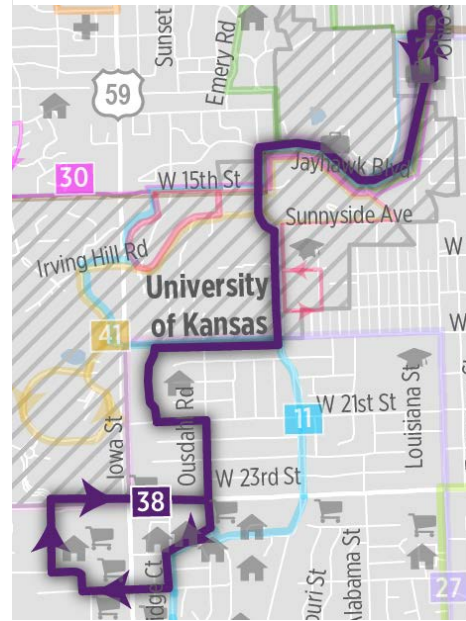

| | "Yellow" Service Day | | "Blue" Service Day | | "Green" Service Day | |
|---------------|----------------------|---------------------|--------------------|---------------------|---------------------|---------------------|
| | Span of Service | Frequency (Minutes) | Span of Service | Frequency (Minutes) | Span of Service | Frequency (Minutes) |
| Early Morning | 7:00 AM – 7:30 AM | 20 | - | - | - | - |
| Daytime | 7:30 AM – 4:30 PM | 20 | - | - | - | - |
| Evening | 4:30 PM – 7:00 PM | 20 | - | - | - | - |

Route 41 – Becker Drive / Jayhawk Boulevard

KUOW Route

The proposed Route 41 would operate between Becker Drive (West Campus) and Jayhawk Boulevard on the University of Kansas campus. The route is similar to the current Route 41, but with a small alignment adjustment near the Allen Fieldhouse Garage. The proposed route would operate along Irving Hill Road between Iowa Street and Naismith Drive, rather than serving 15th Street between Naismith and Burdick Drive. A more consistent alignment improves access to the Allen Fieldhouse Garage and makes the service easier to understand for anyone trying to make their way back to the garage.

Figure 5-19 | Proposed Future Route 41

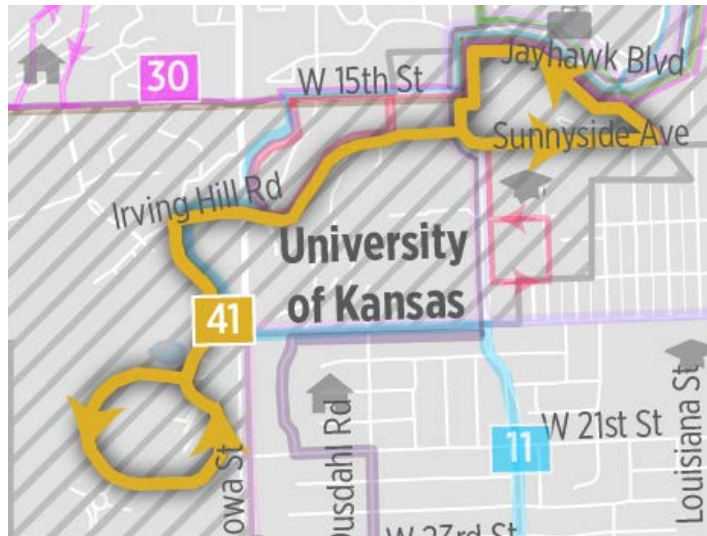

The proposed alignment would facilitate multiple transfer opportunities at along Jayhawk Boulevard, as well as at 19th Street (Route 11).

Key destinations along the proposed alignment include:

- The University of Kansas West Campus
- The University of Kansas

| | "Yellow" Service Day | | "Blue" Service Day | | "Green" Service Day | |
|---------------|----------------------|---------------------|--------------------|---------------------|---------------------|---------------------|
| | Span of Service | Frequency (Minutes) | Span of Service | Frequency (Minutes) | Span of Service | Frequency (Minutes) |
| Early Morning | 7:00 AM – 7:30 AM | 15 | - | - | - | - |
| Daytime | 7:30 AM – 4:30 PM | 7 | - | - | - | - |
| Evening | 4:30 PM – 7:00 PM | 15 | - | - | - | - |

Route 42 – KU Evening/Summer Circulator

KUOW Route

The proposed Route 42 would operate as an evening-only circulator on the University of Kansas campus. The route would replace several other routes after 7:00 pm and operate until approximately 11:00 pm.

The proposed Route 42 alignment would have two branches: one branch would operate between West Campus and the Rec Center, via Daisy Hill, while the other branch would operate between the Rec Center and GSP, via Sunnyside Avenue, Jayhawk Boulevard, and West Campus Road.

The entire circuit from Becker Drive to GSP and back is approximately eight miles, meaning that three vehicles could provide 20-minute service frequency on the route. Splitting the route into two would be operationally inefficient because each branch would require two vehicles, compared to the three total vehicle needed to operate both branches as a circuit. However, the branches could be presented as two separate routes to riders by simply changing the vehicle destination sign each time a bus reaches the Rec Center. When the Central District project (including new student housing along 18th Street) is completed, splitting the proposed route into two separate routes will be more important to consider. One route could serve West Campus, before completing a loop along Irving Hill Road, Naismith Drive, 18th Street, and Ellis Drive. The other route would be identical to the previously mentioned alignment between the Rec Center and GSP.

Figure 5-20 | Proposed Future Route 42

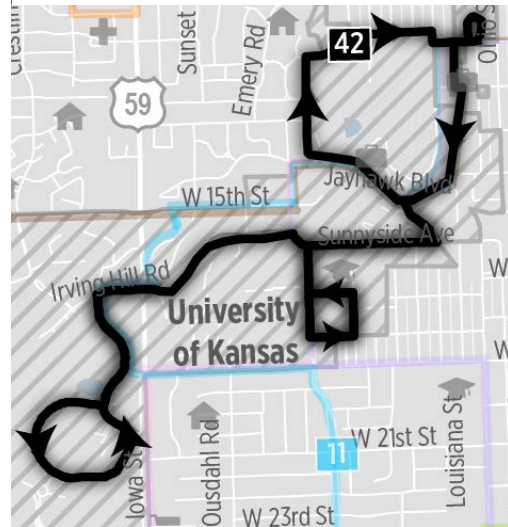

Key destinations along the proposed alignment include:

- The University of Kansas

| | "Yellow" Service Day | | "Blue" Service Day | | "Green" Service Day | |
|---------------|----------------------|---------------------|--------------------|---------------------|---------------------|---------------------|
| | Span of Service | Frequency (Minutes) | Span of Service | Frequency (Minutes) | Span of Service | Frequency (Minutes) |
| Early Morning | - | - | 7:00 AM – 7:30 AM | 30 | - | - |
| Daytime | - | - | 7:30 AM – 4:30 PM | 30 | - | - |
| Evening | 7:00 PM – 11:00 PM | 20 | 4:30 PM – 7:00 PM | 30 | - | - |

Route 43 – Daisy Hill / Rec Center

KUOW Route

The proposed Route 43 would operate between the intersection of Engel Road and Irving Road, and the Ambler Student Recreation and Fitness Center near Naismith Road. The route would also serve Jayhawk Boulevard and Sunnyside Avenue, linking Daisy Hill-area student housing to the academic core of campus, as well as to the Rec Center.

With the completion of the Central District project, the proposed Route 43 could be restructured as a full loop by adding service along 18th Street and Ellis Drive.

The proposed alignment would facilitate multiple transfer opportunities along Jayhawk Boulevard and Naismith Drive.

Key destinations along the proposed alignment include:

- The University of Kansas

Figure 5-21 | Proposed Future Route 43

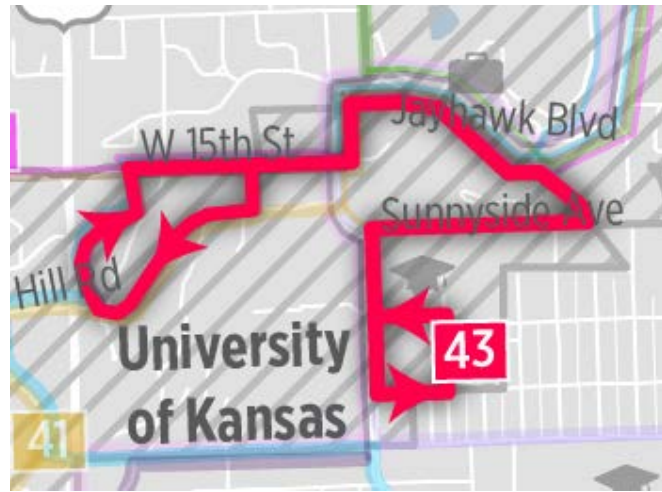

| | "Yellow" Service Day | | "Blue" Service Day | | "Green" Service Day | |
|---------------|----------------------|---------------------|--------------------|---------------------|---------------------|---------------------|
| | Span of Service | Frequency (Minutes) | Span of Service | Frequency (Minutes) | Span of Service | Frequency (Minutes) |
| Early Morning | 7:00 AM – 7:30 AM | 15 | - | - | - | - |
| Daytime | 7:30 AM – 4:30 PM | 7 | - | - | - | - |
| Evening | 4:30 PM – 7:00 PM | 15 | - | - | - | - |

Revenue Hour and Cost Estimates

Figure 5-22 through Figure 5-24 below show the proposed service characteristics of each route, including peak frequency and daily revenue hours for each schedule day type (i.e. “Yellow” Schedule, “Blue” Schedule, etc.). Routes that are shown together in one row are proposed for interlining. Interlining is the practice of operating a single bus or group of buses on multiple routes. Interlining is often used to optimize cycle times and recovery times.^a For example, if one route has insufficient recovery time while another has excessive recovery time, interlining the routes can result in a cycle with an optimal mix of running time and recovery time.

Cycle times that are multiples of 60 allow for the greatest range of clock-face schedules. Clock-face schedules are schedules that result in buses serving a particular stop at the same time or times past every hour (e.g. 1:10, 2:10, 3:10, etc., or 1:00, 1:30, 2:00, 2:30, etc.). Clock-face frequencies make it easy for riders to remember schedules, and make it easier to coordinate connections at key hubs. These factors are most important for transit services that operate less often than every 15 minutes. When service runs more frequently than every 15 minutes, riders tend to pay little attention to schedules at all, since buses are expected to arrive within a short period of time, regardless of when the passenger reaches a bus stop. Additionally, clock-face frequencies are less critical for systems that provide real-time bus arrival information to passengers at bus stops or via mobile application. However, even with real-time arrival information, passengers tend to prefer the simplicity of clock-face schedules, especially those passengers who may not have access to a mobile device or who have limited-use cellular plans because they cannot easily access the real-time information.

Clock-face schedules are proposed for all of the recommended routes, and recovery times are projected to fall between 10 and 20 percent of total cycle time for nearly every route. When recovery time is less than 10 percent of total cycle time, there is a high risk of poor on-time performance because there is insufficient buffering between trips. With insufficient recovery time, one late trip can lead to another, causing a bus to get further and further behind schedule. On the other hand, if there is more than 20 percent recovery time in a schedule, buses are sitting unproductively for long periods of time.

In the tables below, routes are color-coded according to funding source. Red routes indicate Lawrence Transit routes; blue routes are KUOW routes; and purple routes are coordinated between the two entities.

^a Recovery time is the time between trips that allows a driver to use the restroom or just prepare for the next trip. For a given trip, cycle time is the running time plus recovery time.

LAWRENCE TRANSIT COA | SERVICE RECOMMENDATIONS
Lawrence-Douglas County MPO

Figure 5-22 | "Yellow" Service Day Operating Characteristics

| "Yellow" Service Day | | | | | | | | | | | | | |
|-----------------------|----------------------|-------------------------|----------|------------|---------------|------------------|----------------|---------------|--------------------|-------------------|---------------------|-----------------------|----------------------|
| Proposed Route | Avg Round Trip Miles | Estimated Average Speed | Run Time | Cycle Time | Recovery Time | Percent Recovery | Peak Frequency | Peak Vehicles | Off-Peak Frequency | Off-Peak Vehicles | Revenue Hours | Estimated Cost Per RH | Estimated Daily Cost |
| Route 1 | 10.9 | 13 | 0:50 | 1:00 | 0:09 | 16% | 0:30 | 2.0 | 0:30 | 2.0 | 28:00 | \$ 70.90 | \$ 1,985.20 |
| Route 2 + 3 | 20.9 | 13 | 1:36 | 2:00 | 0:23 | 20% | 1:00 | 2.0 | 1:00 | 2.0 | 28:00 | \$ 70.90 | \$ 1,985.20 |
| Route 6 | 17.5 | 13 | 1:20 | 1:30 | 0:09 | 10% | 0:30 | 3.0 | 0:30 | 3.0 | 42:00 | \$ 70.90 | \$ 2,977.80 |
| Route 7 + 15 | 24 | 14 | 1:42 | 2:00 | 0:17 | 14% | 0:30 | 4.0 | 0:30 | 4.0 | 56:00 | \$ 70.90 | \$ 3,970.40 |
| Route 10 + 27 | 25.2 | 13 | 1:56 | 2:30 | 0:33 | 22% | 0:30 | 5.0 | 0:30 | 5.0 | 70:00 | \$ 70.90 | \$ 4,963.00 |
| Route 11 + 29 | 21.9 | 13 | 1:41 | 2:00 | 0:18 | 16% | 0:20 | 6.0 | 0:30 | 4.0 | 62:00 | \$ 70.90 | \$ 4,395.80 |
| Route 30 + 38 | 13.2 | 12 | 1:06 | 1:20 | 0:14 | 18% | 0:20 | 4.0 | 0:20 | 4.0 | 48:00 | \$ 70.90 | \$ 3,403.20 |
| Route 36 | 10 | 12 | 0:50 | 1:00 | 0:10 | 17% | 0:20 | 3.0 | 0:30 | 2.0 | 33:00 | \$ 70.90 | \$ 2,339.70 |
| Route 41 | 4.1 | 10 | 0:24 | 0:30 | 0:05 | 18% | 0:07 | 4.0 | 0:15 | 2.0 | 42:00 | \$ 70.90 | \$ 2,977.80 |
| Route 43 | 4.1 | 10 | 0:24 | 0:30 | 0:05 | 18% | 0:07 | 4.0 | 0:15 | 2.0 | 42:00 | \$ 70.90 | \$ 2,977.80 |
| Route 42 | 7.7 | 10 | 0:46 | 1:00 | 0:13 | 23% | 0:20 | 3.0 | 0:20 | 3.0 | 12:00 | \$ 70.90 | \$ 850.80 |
| In-Fill Bus | 6.9 | 12 | 0:34 | 0:34 | 0:00 | 0% | 0:34 | 1.0 | 0:20 | 1.7 | 4:00 | \$ 70.90 | \$ 283.60 |
| Total Proposed | | | | | | | | 41.0 | 34.7 | 467:00 | \$ 33,110.30 | | |

-
 - Lawrence Transit
-
 - Coordinated Routes
-
 - KU on Wheels

LAWRENCE TRANSIT COA | FINAL REPORT
Lawrence-Douglas County MPO

Figure 5-23 | “Blue” Service Day Operating Characteristics

| "Blue" Service Day | | | | | | | | | | | | | |
|-----------------------|----------------------|-------------------------|----------|------------|---------------|------------------|----------------|---------------|--------------------|-------------------|---------------------|-----------------------|----------------------|
| Proposed Route | Avg Round Trip Miles | Estimated Average Speed | Run Time | Cycle Time | Recovery Time | Percent Recovery | Peak Frequency | Peak Vehicles | Off-Peak Frequency | Off-Peak Vehicles | Revenue Hours | Estimated Cost Per RH | Estimated Daily Cost |
| Route 1 | 10.9 | 13 | 0:50 | 1:00 | 0:09 | 16% | 0:30 | 2.0 | 0:30 | 2.0 | 28:00 | \$70.90 | \$ 1,985.20 |
| Route 2 + 3 | 20.9 | 13 | 1:36 | 2:00 | 0:23 | 20% | 1:00 | 2.0 | 1:00 | 2.0 | 28:00 | \$70.90 | \$ 1,985.20 |
| Route 6 | 17.5 | 13 | 1:20 | 1:30 | 0:09 | 10% | 0:30 | 3.0 | 0:30 | 3.0 | 42:00 | \$70.90 | \$ 2,977.80 |
| Route 7 + 15 | 24 | 14 | 1:42 | 2:00 | 0:17 | 14% | 0:30 | 4.0 | 0:30 | 4.0 | 56:00 | \$70.90 | \$ 3,970.40 |
| Route 10 + 27 | 25.2 | 13 | 1:56 | 2:30 | 0:33 | 22% | 0:30 | 5.0 | 0:30 | 5.0 | 70:00 | \$70.90 | \$ 4,963.00 |
| Route 11 + 29 | 21.9 | 13 | 1:41 | 2:00 | 0:18 | 16% | 1:00 | 2.0 | 1:00 | 2.0 | 26:00 | \$70.90 | \$ 1,843.40 |
| Route 42 | 7.7 | 10 | 0:46 | 1:00 | 0:13 | 23% | 0:30 | 2.0 | 0:30 | 2.0 | 24:00 | \$70.90 | \$ 1,701.60 |
| Total Proposed | | | | | | | | 20.0 | 20.0 | 274:00 | \$ 19,426.60 | | |

Figure 5-24 | “Green” Service Day Operating Characteristics

| "Green" Service Day | | | | | | | | | | | | | |
|-----------------------|----------------------|-------------------------|----------|------------|---------------|------------------|----------------|---------------|--------------------|-------------------|---------------------|-----------------------|----------------------|
| Proposed Route | Avg Round Trip Miles | Estimated Average Speed | Run Time | Cycle Time | Recovery Time | Percent Recovery | Peak Frequency | Peak Vehicles | Off-Peak Frequency | Off-Peak Vehicles | Revenue Hours | Estimated Cost Per RH | Estimated Daily Cost |
| Route 1 | 10.9 | 13 | 0:50 | 1:00 | 0:09 | 16% | 1:00 | 1.0 | 1:00 | 1.0 | 12:00 | \$70.90 | \$ 850.80 |
| Route 2 + 3 | 20.9 | 13 | 1:36 | 2:00 | 0:23 | 20% | 1:00 | 2.0 | 1:00 | 2.0 | 24:00 | \$70.90 | \$ 1,701.60 |
| Route 6 | 17.5 | 13 | 1:20 | 1:30 | 0:09 | 10% | 0:30 | 3.0 | 0:30 | 3.0 | 36:00 | \$70.90 | \$ 2,552.40 |
| Route 7 + 15 | 24 | 14 | 1:42 | 2:00 | 0:17 | 14% | 0:30 | 4.0 | 0:30 | 4.0 | 48:00 | \$70.90 | \$ 3,403.20 |
| Route 10 + 27 | 25.2 | 14 | 1:48 | 2:00 | 0:12 | 10% | 0:30 | 4.0 | 0:30 | 4.0 | 48:00 | \$70.90 | \$ 3,403.20 |
| Route 11 + 29S | 19.9 | 13 | 1:31 | 2:00 | 0:28 | 23% | 0:30 | 4.0 | 0:30 | 4.0 | 48:00 | \$70.90 | \$ 3,403.20 |
| Total Proposed | | | | | | | | 18.0 | 18.0 | 216:00 | \$ 15,314.40 | | |

-
 - Lawrence Transit
-
 - Coordinated Routes
-
 - KU on Wheels

Figure 5-25 shows a comparison between the current and proposed annual hours of service for Lawrence Transit, KUOW, and coordinated routes. When taken as a whole, the recommended service redesign would result in nearly no change in annual revenue hours. However, this impact would vary by sponsor. The proposed revenue hours for Lawrence Transit routes would increase by 7 percent. KUOW revenue hours would increase by 1 percent, and coordinated routes would see a 23 percent decrease in annual revenue hours under the recommended scenario.

These impacts could be adjusted by trimming service hours or reducing frequencies on some routes. However, the recommendations presented here represent the study team’s assessment of the optimal short-term balance between ridership and productivity. While Routes 11 and 29 are designated as the two coordinated routes in the recommended scenario, based on their high percentage of KU-affiliated ridership, Route 27 could also be considered for this category in the future if the proposed alignment is implemented.

Figure 5-25 | Comparison of Current and Proposed Annual Revenue Hours of Service

| | "Yellow" Service Day | | "Blue" Service Day | | "Green" Service Day | | Annual Total | | Annual Difference | |
|---------------------|----------------------|---------------|--------------------|---------------|---------------------|---------------|----------------|----------------|-------------------|-----------|
| | Current | Proposed | Current | Proposed | Current | Proposed | Current | Proposed | Total | % |
| Lawrence Transit | 32,034 | 34,944 | 17,849 | 20,608 | 11,449 | 9,912 | 61,332 | 65,464 | 4,132 | 7% |
| Coordinated Routes | 12,431 | 9,672 | 4,249 | 2,392 | 2,719 | 2,832 | 19,398 | 14,896 | (4,502) | (23%) |
| KUOW | 29,022 | 28,236 | 1,104 | 2,208 | 0 | 0 | 30,126 | 30,444 | 318 | 1% |
| Annual Total | 73,487 | 72,852 | 23,202 | 25,208 | 14,168 | 12,744 | 110,857 | 110,804 | (53) | 0% |

Americans with Disabilities Act (ADA) Impacts

The service area footprint for the current and final recommended route network are nearly the same, as shown in Figure 5-26 and Figure 5-27. The redesigned Route 7 service will require paratransit service to extend slightly further south of West 31st Street and HINU. Primary areas where fixed-route service has been reduced include along Wakarusa Drive between Bob Billings and Clinton Parkways, along Kasold Drive between Peterson Road and Farmer’s Turnpike, along Peterson Road between Kasold Drive and North Iowa Street, and along Kasold Drive south of Clinton Parkway. In the case of Wakarusa Drive, service along the cross streets of Bob Billings and Clinton Parkways means that the ¾-mile buffer around the fixed-routes covers the areas to the east and west of Wakarusa Drive. Paratransit service also remains available surrounding Kasold Drive south of Clinton Parkway because Routes 27 and 29 still operate close enough such that the required ¾-mile buffer covers the area. Thus, most ADA impacts (i.e. loss of service) will be felt in northern Lawrence in the small area surrounding Monterey Way, Kasold Drive, and Peterson Road. In addition, while direct fixed-route service to the Peaslee Center has been removed in the final recommendations, the buffer around Route 15 means that paratransit service to the Peaslee Center is still available.

ADA impacts can also be felt as a result of reduced or added service hours or days. The final recommendations propose beginning Saturday service after 8:00 AM, compared to the current Saturday schedules, which begin in the 6:00-hour. This would, in turn, reduce Lawrence Transit’s obligation to provide ADA paratransit service by two hours on Saturdays as well.

LAWRENCE TRANSIT COA | FINAL REPORT
Lawrence-Douglas County MPO

Figure 5-26 | ADA Paratransit Service Area (3/4-mile buffer) of Existing Service

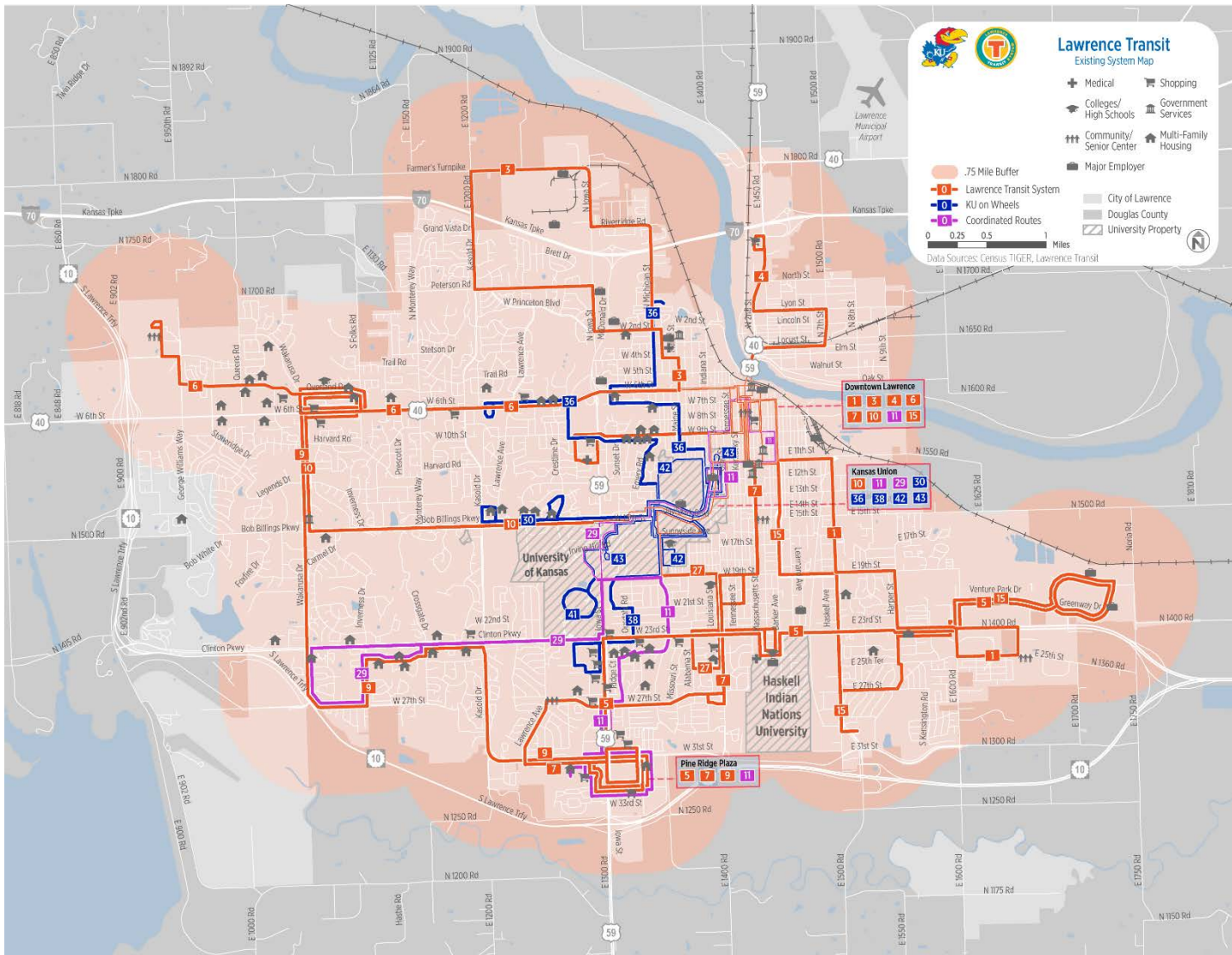

LAWRENCE TRANSIT COA | SERVICE RECOMMENDATIONS
Lawrence-Douglas County MPO

Figure 5-27 | ADA Paratransit Service Area (3/4-mile buffer) of Proposed Service

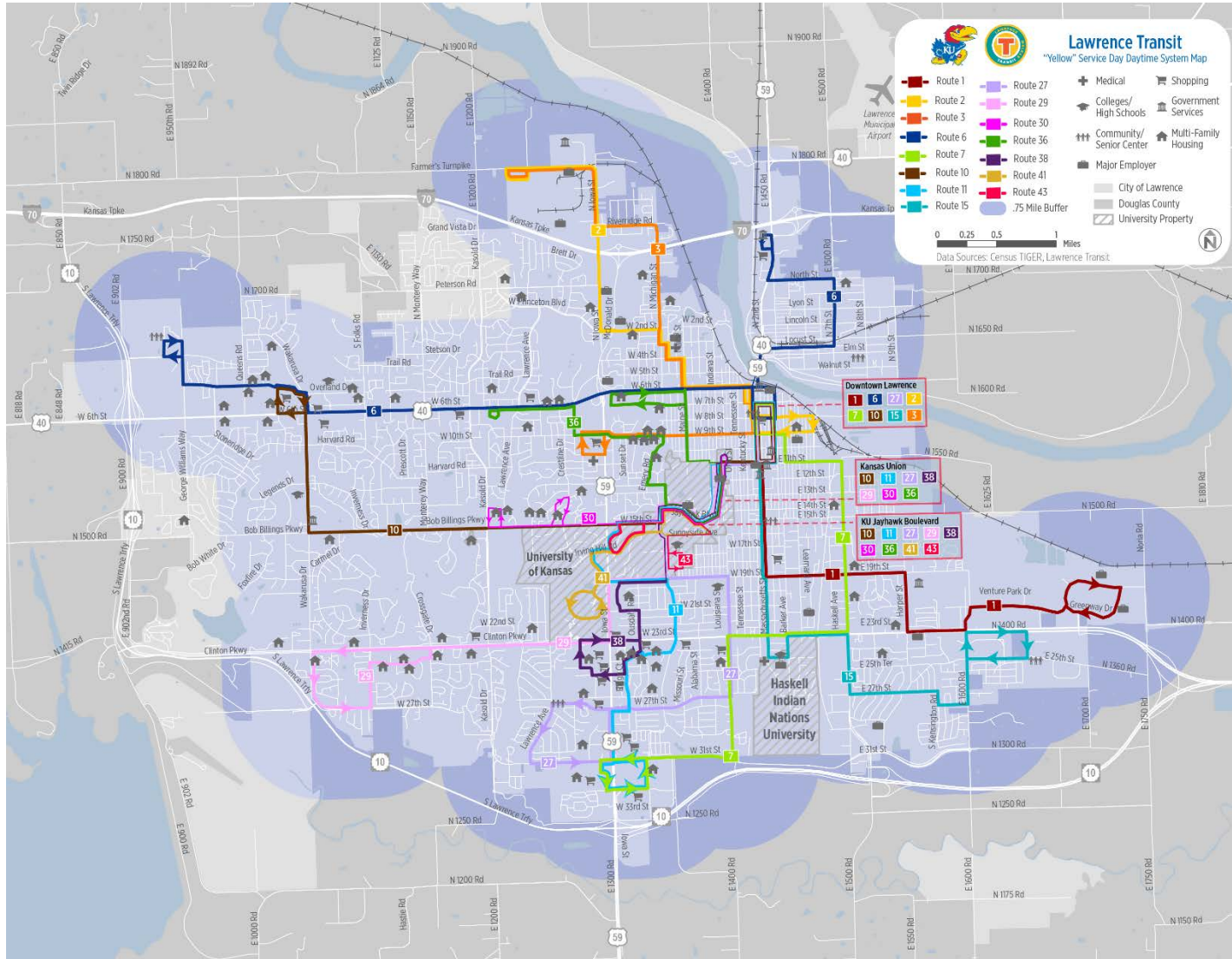

Long-Term Recommendations

In developing the service scenario described above, the study team was aiming for a cost-neutral redesign of Lawrence’s transit network. While the final recommended scenario resulted in a 2 percent increase in total annual revenue hours, this increase is within a range that can be managed relatively easily if the funding to support it is not immediately available (i.e. through minimal reductions in service spans or frequencies). However, additional opportunities exist to improve and expand transit service in Lawrence. The long-term recommendations described below are derived from the market analysis, service analysis, and public comments. These recommendations are not cost-constrained and would require additional analysis (and funding) before implementation.

Innovative Demand-Response Service

As noted, some areas of Lawrence lack the density to support traditional fixed-route service. Other areas may have the needed density but lack the street network to support efficient transit operations. In both cases, demand-response service can provide a viable mobility solution in place of fixed-route service. In Lawrence and elsewhere, demand-response service has historically been provided by transit operators using smaller (15-22 passenger) vehicles dispatched via a centralized call center. This was the model previously employed for Route 3 covering northern Lawrence. Increasingly, though, demand-response service is being provided through partnerships between transit providers and Transportation Network Companies (TNCs) such as Uber and Lyft.

TNCs operate a technology platform that connects drivers of privately owned vehicles with potential passengers via a smartphone application. Passengers are charged a fare, and drivers are charged a service fee for use of the TNC platform. Some cities and transit agencies have begun subsidizing specific TNC trip types, such as late-night service, or first/last mile connections to and from fixed-route transit hubs. Subsidies can make TNC trip costs comparable to transit fares.

The Pinellas Suncoast Transit Authority (PSTA), in St. Petersburg, FL has been a pioneer in the use of subsidized TNC service. In 2016, PSTA launched a pilot program called DirectConnect that allows residents of two designated service zones to request either Uber or an authorized taxi service to a nearby transit center or bus stop where they can transfer to the regional fixed-route network. PSTA covers half of the fare for these trips, up to a maximum of \$3. To receive the subsidized fare, passengers must enter a special code into their Uber app, or call the authorized taxi provider and request the special fare. The option of requesting either Uber or a taxi allows PSTA to balance convenience and accessibility, as some residents may not have access to a smart phones or other mobile device. A similar approach could be taken in Lawrence, where both Uber service and taxis are already operating.

Figure 5-28 | Subsidized TNC Service in Pinellas County, FL



While subsidized TNC service can be a viable replacement for unproductive fixed-route service, it can also complement transit service more generally. For example, the subsidy can be offered on certain days, or at certain hours when the demand for transit service is too low to justify fixed-route operations but some transit need still exists. A second PSTA pilot program called TD (Transportation Disadvantaged) Late Shift gives low-income residents up to 23 free Uber trips per month between the hours of 9:00 PM and 6:00 AM, when bus service is not available. Subsidized trips must be between a place of employment and residence.

Besides the PSTA programs, there are several other innovative demand-response pilot programs underway. Each takes a slightly different approach to subsidized demand-response service:

- In Denton County, TX, the Denton County Transportation Authority (DCTA) is offering \$2 discounts off Uber trips taken within the town of Highland Village, a suburban bedroom community that lacks the density or land-use to support fixed-route service. The discount is available during regular DCTA service hours only.
- In Philadelphia, the Southeastern Pennsylvania Transportation Authority (SEPTA) is offering a 40 percent discount off Uber fares to select SEPTA rail stations, up to a maximum subsidy of \$10. The program is aimed at facilitating first/last mile connections to and from suburban transit hubs with parking capacity issues.
- In Dublin, CA, the Livermore Amador Valley Transit Authority (LAVTA) is subsidizing Uber trips in two designated zones to guarantee that trips costs do not exceed \$5 for passengers. The pilot program has allowed LAVTA to eliminate an unproductive bus route serving the same area.

A key benefit of subsidized TNC service, as compared to more traditional demand-response service, is that Lawrence Transit (if it were the sponsor) would only be responsible for subsidizing trips that actually occur. Lawrence Transit would not be responsible for the procurement and maintenance of vehicles, or for the salaries and benefits of drivers. Indeed, the primary barriers to overcome in such partnerships are regulatory. For example, some communities require that TNCs follow the same driver vetting process as transit operators. However, if agreements on these issues can be reached, subsidized TNC service can provide Lawrence Transit with an invaluable tool for expanding mobility, as well as for gauging the demand for future fixed-route service. Areas with high demand for subsidized TNC service are strong candidates for future fixed-route service expansion. In growing areas, such as the neighborhoods near Free State High School, subsidized TNC service can be a precursor to fixed-route service, allowing Lawrence Transit to study the emerging travel patterns before strategically expanding the fixed-route network.

Expand Route 42 Service

The proposed Route 42, discussed previously, would operate as an evening-only campus circulator when other routes are not in service (7:00 PM – 11:00 PM). In the short-term, the route would operate on weekdays only. However, the KU campus is a 24-hour environment with activities taking place every day of the week. The introduction of a dedicated campus-wide circulator for weeknights is a logical first step toward the eventual expansion of this service to Saturdays and/or Sundays. Some universities provide circulators on Sundays, but not Saturdays, to provide transportation between remote parking lots and the core of campus when students return from weekends away, and to reflect the fact that many students take Saturdays off from academics but return to studying on Sunday afternoons/evenings.

Another expansion to consider for Route 42 is the addition of service through the Central District. Figure 5-29 shows how Route 42 could be split into two routes to serve the south and west sides of campus (including the Central District) and, separately, the north side of campus. The Ambler Student Recreation and Fitness Center would serve as a hub and transfer point for both routes. During the October 2016 public meetings, several students expressed support for more direct service between areas of student housing and the Rec Center. The proposed long-term alignment for Routes 42 and 44 would make the Rec Center easily accessible from Irving Hill, GSP and, to a lesser extent, the Greek housing along Emery Road.

Good connections to the Rec Center and Naismith Road would also allow other service to be streamlined. For example, Route 11 operates along a rather circuitous alignment, in part to facilitate trips between Daisy Hill and the retail destination near Iowa and 33rd Street. Route 42 would allow students living on campus to make connections on Naismith Drive, which would then allow Route 11 service to shift to Naismith Drive north of 19th Street.

Figure 5-29 | Potential Future Routes 42 and 44

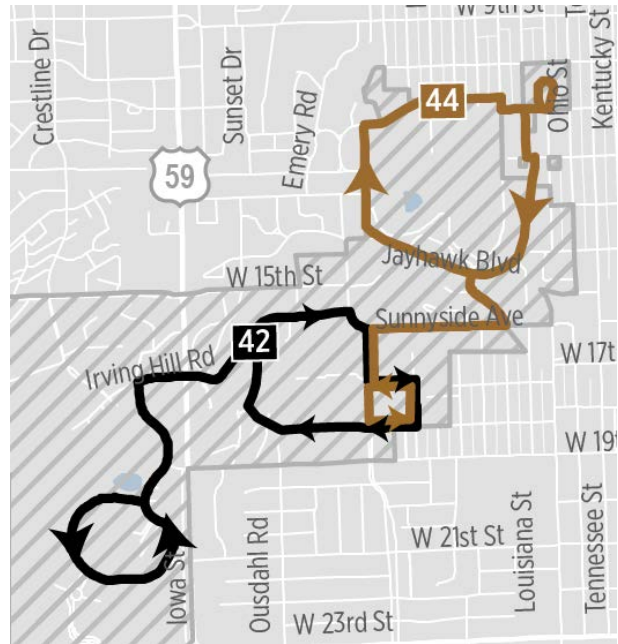

Expand Service to Growing Areas

In addition to the KU's Central District project, areas of Lawrence that have seen significant levels of development in recent years are downtown Lawrence, the Lawrence Venture Park, and the western 6th Street corridor between Folks Road and K-10. Downtown Lawrence is already well-served and will continue to be with the recommended redesign scenario. Development at the Lawrence Venture Park has been limited to roadway and utilities improvements so far, but this infrastructure investment, combined with economic incentives, makes the area poised for substantial employment growth in future years. Together with the East Hills Business Park, the built-out Lawrence Venture Park will make far eastern Lawrence a major employment hub.

The proposed Route 5 shown in Figure 5-30 would provide additional connections to Venture Park and the East Hills Business Park by linking the area directly to the KU campus. This would improve access to the

Figure 5-30 | Proposed Future Route 5

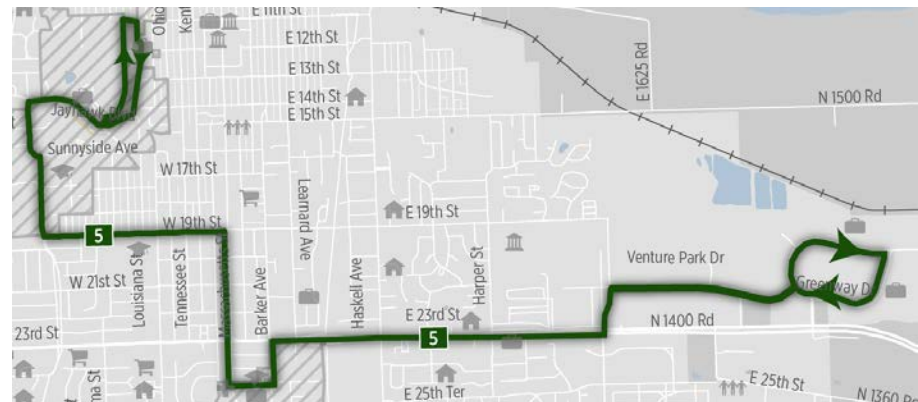

future employment hub for residents of northwest and southwest Lawrence, as well as for KU students who may find internships or part-time work at the business parks. The proposed route would also provide job-access opportunities for HINU students and link the HINU campus directly to KU. While HINU has not traditionally generated strong ridership for Lawrence Transit, more convenient connections to both KU and downtown Lawrence may generate greater interest. Several HINU students indicated in surveys that they regularly use library facilities at KU and also take courses at KU through the Bridge program.

The western 6th Street Corridor has seen very strong residential growth in recent years, with several new apartment complexes built or currently under construction. The land-use and development patterns of this area including high density and pedestrian amenities make it well-suited for additional transit service. As mentioned previously in this report, the proposed Route 10 could be extended from Walmart to Rock Chalk Park, providing additional service frequency and more direct connections to the new apartment developments along Overland Drive. In the longer-term, the Walmart on Overland Drive could become a secondary hub for Lawrence Transit, similar to the Walmart on 33rd Street. This hub could serve as a transfer point for a network of future routes service the growing neighborhoods of western Lawrence.

Formalize Peak-Period In-Fill Service

Lawrence Transit and KUOW currently operate a service protection bus during morning peak periods that is intended to provide additional capacity for routes serving The Reserve and Rockland East apartments. This in-fill service is not publicized, giving the transit operators the flexibility to dispatch it whenever needed. However, the routing that this bus typically follows directly address a common complaint of student living at The Reserve, which is that trips to campus on Route 11 are too long and circuitous. Under the recommended service redesign scenario, The Reserve would instead be served by Route 27, which would serve KU via Louisiana Street. Thus, the perception among students that their trip from The Reserve to campus could be more direct would continue.

Formalizing the route shown in Figure 5-31 by publicizing it and assigning it a route number would address the issues expressed by students living at The Reserve. The route could be operated at peak periods only, when demand for capacity is greatest. If schedules are staggered with Route 11, this route would create 10- to 15-minute service frequency for residents of Rockland East and nearby apartments during peak periods.

Figure 5-31 | Current In-Fill Route

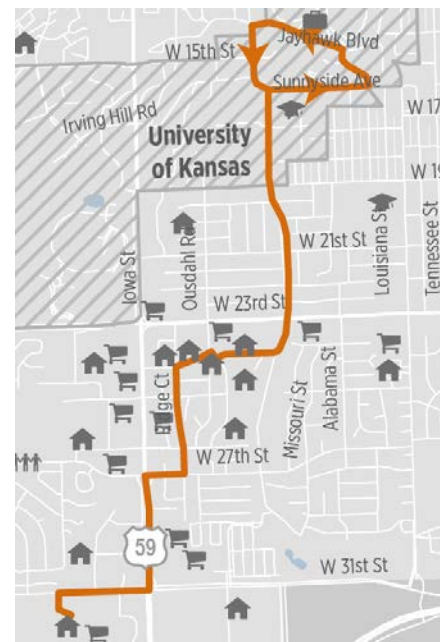

Expand Lawrence Transit Frequency and Span of Service

Through the Lawrence Transit COA study, the desire for more frequent service and/or later service hours were common themes among survey and public meeting participants. In trade-off questions, survey participants were nearly evenly split between preferring more frequent service (51 percent) and later service hours (49 percent). This suggests the importance of both goals.

Even when unprompted, many survey participants offered frequency and span-related free-response comments like these:

- “We think having the bus run every 30 minutes -dependably- has, and will continue to, improve patronage.”
- “It would be beneficial for riders to count on buses running at least until 9 p.m., and late-hours during Summer time.”
- “Currently the routes and schedules are very convenient for me, the recent change to 30 min vs. 60 min waits was major upgrade. Still the lack of Sunday and evening service is very annoying.”
- “I wish there were later service hours for the regular bus system that service non-KU areas of Lawrence. I know that's probably not feasible -- just expressing my wish!”

A review of 12 peer systems with similar community characteristics to Lawrence, showed that all but two offer service past 9:00 PM on at least some routes (see Figure 5-32). This assessment did not include special “night owl” service that many communities (including Lawrence) with large universities offer. By comparison, no Lawrence Transit routes currently operate past 8:00 PM.

Figure 5-32 | Latest Departure Times on Transit Systems Comparable to Lawrence Transit

| City | Service Provider | University | Latest Departure* |
|------------------|--|------------------------------|-------------------|
| Muncie, IN | Muncie Indiana Transit System | Ball State University | 9:15 PM |
| Ames, IA | Ames Transit Agency dba CyRide | Iowa State University | 12:12 AM |
| Lafayette, IN | Greater Lafayette Public Transportation Corporation | Purdue University | 11:45 PM |
| Normal, IL | Bloomington-Normal Public Transit System | Illinois State University | 9:15 PM |
| Athens, GA | Athens Transit System/University of Georgia Transit System | University of Georgia | 8:45 PM |
| Iowa City, IA | Iowa City Transit/University of Iowa | University of Iowa | 9:45 PM |
| Columbia, MO | City of Columbia | University of Missouri | 7:30 PM |
| Bloomington, IN | Bloomington Public Transportation Corporation | University of Indiana | 11:10 PM |
| Chapel Hill, NC | Chapel Hill Transit | University of North Carolina | 9:50 PM |
| Missoula, MT | Missoula Urban Transportation District/The University of Montana (ASUM Transportation) | University of Montana | 9:20 PM |
| Harrisonburg, VA | City of Harrisonburg Department of Public Transportation | James Madison University | 9:40 PM |
| Fargo, ND | City of Fargo, dba Metropolitan Area Transit | North Dakota State | 10:45 PM |

*Not including Night Owl service.

Expanding service past 8:00 PM should be a goal for Lawrence Transit, particularly on routes showing clear evidence of demand for later service. For example, ridership patterns on Route 11 (see Figure 5-33) show that rather than tapering off, outbound ridership actually increases on the last trip of the day, compared to several trips before it. This suggests a relative rush to catch the last trip of the evening but also indicates that later service would likely be well-received by Route

11 riders. In addition to Route 11, the outbound directions of Route 4 and Route 15 showed upward ridership trends on the last trip of the day during the COA survey period.

Lawrence Transit has been prudent in determining which routes should receive higher service frequency (recently increasing the frequency of Routes 5, 7, and 10 from hourly to every 30 minutes due to strong demand) and could follow a similar approach with service hours. The recommended redesign scenario discussed earlier in this chapter does not include service past 8:00 PM on any Lawrence Transit routes, but the short-term scenario does include recommendations for ways to make each route fundamentally more productive. By continuing to track ridership patterns after implementation, Lawrence Transit staff can determine which routes are most suitable for later service hours.

In general, Lawrence Transit should consider a goal of eventually providing service until at least 9:00 PM on all routes, just as it has set the goal of eventually providing a minimum of 30-minute service frequency on all routes.

The final recommended service redesign scenario includes 30-minute or better service frequency on all but two routes. Routes 2 and 3 would operate hourly under the short-term scenario. However, these routes would provide a combined 30-minute frequency from where they converge at Lawrence Memorial Hospital to downtown Lawrence. If these two hourly routes show strong ridership outside of the common corridor that they share, they should also be considered for 30-minute service frequency in the long-term.

Figure 5-33 | Route 11 – Outbound Weekday Ridership by Trip

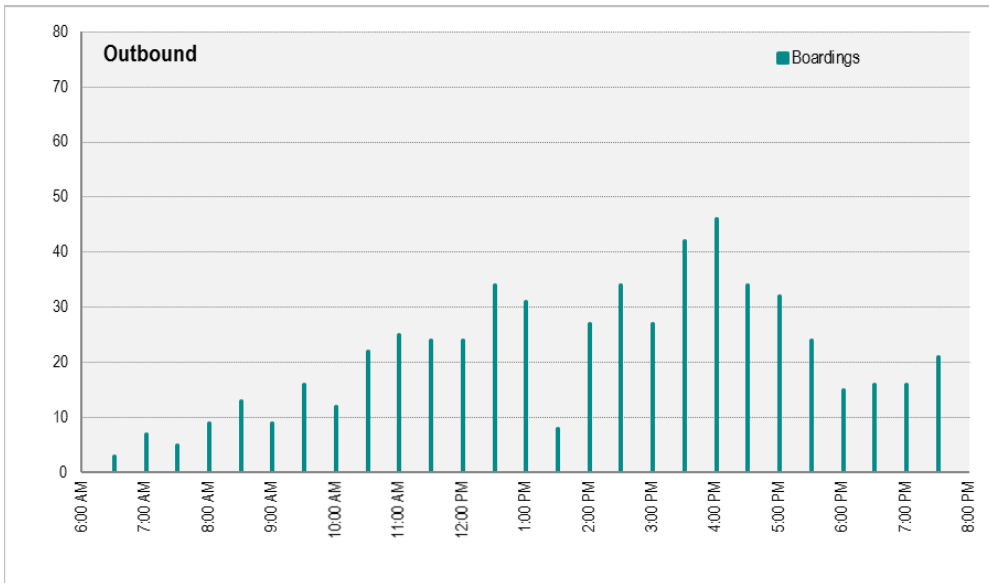

Passenger Amenities and Facilities

Higher-frequency service improves the transit experience for riders in two important ways. First, it reduces the wait time for passengers using the service in general, and secondly it reduces the inconvenience of transfers. When service is infrequent, most transfers occur at designated hubs where routes can be “pulsed” to the greatest extent possible. Pulsing is the scheduling of multiple routes to arrive at the same hub within a very small time window in order to facilitate transfers between routes. When service is more frequent, transfers outside of key hubs become more viable. For example, if two routes operate every 30-minutes, the maximum wait time to transfer between

them at any point where they intersect is 30 minutes, but may be much less depending on where along their respective alignments they intersect. Thus, higher service frequency makes passenger amenities such as benches and shelters more important since passengers are more likely to make transfer away from designated hubs.

The design features of the proposed redesign scenario, including consolidating service on key corridors to improve effective service frequency are likely to generate higher transfer activity at key intersections in the network, including the following:

- Maine and 6th Street, where passengers would be able to transfer between Routes, 2, 3, 6, and 36,
- 9th Street and Vermont or New Hampshire, where passengers would be able to transfer between Route 1, 2, 3, 7, 10, 15, and 27,
- 23rd Street and Louisiana Street, where passengers would be able to transfer between Routes 7 and 27 for service to downtown Lawrence or the University of Kansas.

These intersections, in addition to key ridership generators such as Walmart, should be the focus for future passenger amenity investments. Passenger amenities enhance the transit experience, decrease perceived wait times for transit services, and can contribute to increased ridership. Well-designed amenities are also an important marketing tool by increasing the visibility of transit service and projecting a positive image of the user experience. Overall, a strategic investment in passenger amenities is relatively low-cost, high-reward strategy for Lawrence Transit to pursue in the long-term.

Higher frequency service, coupled with more on-street passenger amenities may reduce the need for a single central hub of the type that Lawrence Transit envisioned in its 2016 Tiger Grant application. Nevertheless, a central hub will likely continue to be a goal for Lawrence Transit for other reasons. The two current primary transit hubs in Lawrence, Vermont Street near 7th in downtown Lawrence, and the Kansas Union, are not ideal locations from a safety perspective. In both cases, passengers alighting buses on the northbound side of the street are tempted to immediately cross the street to reach a major destination (the Lawrence Public Library on Vermont Street and the Kansas Union on Jayhawk Boulevard). On Vermont Street, there is no mid-block crosswalk to support these crossings. On Jayhawk Boulevard, there is a crosswalk, but stopped buses block the view of the walk for approaching vehicles, giving drivers little warning when pedestrians begin to cross the street.

The safety-related shortcomings of the existing hubs could be addressed through pedestrian-supportive treatments including a mid-block crosswalk on Vermont Street and raised crosswalks with motion-activated warning lights embedded in the pavement at both locations (see Figure 5-34). However, in the case of Vermont Street, the addition of a mid-block crosswalk would reduce bus layover-space, which at the current 330 linear feet is already less than the 350 feet deemed necessary for effective bus operations.

The need for sufficient layover space and space for transit-supportive services (pass sales, information desk, restrooms, waiting areas, etc.) will likely continue to make a central hub a long-term goal of the CS. Ideally, such a hub would be within walking distance of the KU campus core to avoid imposing a forced transfer on passengers traveling to campus (i.e. the vast majority of transit riders in Lawrence). Since the KU campus is large and hilly, the option of a campus circulator will always be necessary for riders who prefer riding to walking. Proximity to campus will ensure that such a service could provide fast and frequent links to and from a central hub as efficiently as possible.

Figure 5-34 | Example of Pedestrian-Supportive Street Treatments



Update Real-Time Information App

MV Transit operates the “Where’s My Bus?” smartphone app, which allows current and prospective transit users to track fixed-route buses and view scheduled arrival times on mobile devices. However, the app is not well rated by users. The primary complaints are repeated network failure (crashes) and that the app’s maps and navigation are not clear. Updating the real-time information app—either through “Where’s My Bus?” or with another vendor—will help better inform Lawrence residents of their available transit options. An example of the comments related to the app provided by survey and public meeting participants included the following:

- “A very important improvement would be to update the MV Transit app, the text service, and the website when small reroutes are needed to avoid construction or street problems so riders can determine if their stop is active and avoid being late to work or class, because people can miss an important exam or be fired when they don't know their stop isn't active. This is for all routes.”

Users of the app have also left comments online through the Google Play Store and the Apple App Store. Recent comments include:

- “You need to already know your way around and the numbers of routes. Not great in a college town with thousands of new residents each year. Its less helpful than Lawrence transits website.”
- “Works 1 time out of 20 Always says "unable to connect to server" and never allows me to see times.”

Providing reliable real-time transit information is key to providing the transit experience expected by the current generation of students and transit riders in general. Continuously improving the local transit app should remain a top long-term priority of Lawrence Transit and KUOW.

Comprehensive Branding Study

Lawrence Transit and KUOW have continued to maintain their individual brands even as they have moved closer to integration in other ways, including sharing a common service contractor, coordinating routes, and in some cases using vehicles interchangeably. Creating a unified brand for all transit services in Lawrence would have pluses and minuses. On the positive side, students who may have the perception that only KUOW service is geared toward their mobility needs, may expand their knowledge and use of other routes under a single brand. On the negative side, some students simply may not consider transit as a viable option if it is not specifically presented as a KU-affiliated service. In addition, service reductions during non-academic periods may create more confusion for Lawrence residents if all services are operated under a single brand.

A long-term marketing and rebranding study could help inform Lawrence Transit and KU staff of the implications of closer brand integration, or conversely, help develop separate but more effective brands and marketing strategies for both systems. Such studies require extensive public outreach including multiple rounds of focus groups to develop and test various branding and communications strategies.

PROPOSED DEMAND-RESPONSE SERVICE RECOMMENDATIONS

The following demand-response service recommendations were developed following an on-site assessment of JayLift and T Lift operations by the study team's paratransit expert. For the most part, the recommendations can be accomplished within a short time frame and do not require increases in funding. These changes are intended to make demand-response services more equitable for users, scheduling more efficient, performance tracking clearer, and services more productive overall.

Transform JayLift into a Campus-only Paratransit Service

Modifying JayLift into an intra-campus service focused on taking disabled students to and from class and on-campus activities would create a simpler and more equitable division of paratransit services in Lawrence. Any trip with an origin and/or destination not on campus would be handled by T Lift so that JayLift can be a campus-only provider.

Examining the data, most off-campus trips are fairly short and come mainly at the beginning and end of runs, so removal of such trips from JayLift may not have a significant impact on the productivity and efficiency of JayLift. However, the Nelson\Nygaard team believes that the benefit of making JayLift focused on students, simpler to understand, and likely somewhat faster outweighs the marginal performance benefit.

The primary benefit to making JayLift the campus provider is to address equity issues with the service. Many off-campus trips are for employees. While there are no fares per se for JayLift, disabled students in effect pay a fare for JayLift through their student fees. This is not true for the KU employees who utilize JayLift, however. They are truly receiving free service. KU management has raised the question on why this is the case and why these individuals cannot be served by T Lift instead for which they would have to pay a fare. The study team agrees with this assessment.

Updates and Changes to Trapeze's PASS Software

A switch in PASS to street routing as the basis for calculating how much time is required to move from one location to another should produce more accurate scheduling than the triangulation

method currently in use. Greater accuracy increases the opportunity to build better schedules with less manual effort. Not only will PASS be able to make better routing decisions on its own, but it may be possible to schedule slightly more aggressively with respect to estimated travel speeds when these speeds can be refined down to types of streets, neighborhoods, and specific street segments – all by user-defined time periods throughout the day. However, for these benefits to be realized, the CS needs to update its underlying map and street network in PASS.

Trapeze’s PASS Version 12, the software used to support T Lift and Night Line services, follows user-specified parameters to schedule trips. In the CS’s system, the DEFAULT parameter set and costing weights are not used; rather, a customized set of parameters (called “T Lift”) was created in July 2002 and has remained unchanged since then (see Figure 5-35 and Figure 5-36). While some of the customized T Lift scheduling parameters are not significantly different from the DEFAULT settings, other variables and all but one of the slide bars in the costing weights are very different.

PASS provides an opportunity to use different sets of parameters that apply to batch scheduling and to scheduling a single trip, respectively. However, the T Lift set of parameters are used for both single insertions and batch scheduling. When PASS was implemented, Trapeze’s installer/trainer spent a considerable amount of time with MV Transit’s manager in setting these parameters; however, MV Transit’s manager does not recall testing the parameters on a sample database and fine-tuning the parameters based on the results. This critical second step often makes the difference between successful use of PASS’s batch scheduling functionality and relying primarily on single insertions and PASS suggested assignments for single trips.

Once the costing weights are adjusted to better match on-the-ground operations, there are likely other scheduling parameters that also need to be revisited. For example, the current “Free Pullouts” setting may be counter-productive in that the setting encourages vehicles that are already committed to service (runs to which trips have already been assigned) to be “rubber-banded” all around the service area to avoid using additional vehicles. The setting should be set close to 100 percent. Similarly, lowering the “OOW (out-of-window) Extra” to half its current value might help constrain PASS from sending vehicles off on indirect and divergent paths.

In addition, there are some unused features of PASS that should also contribute to the goal of more productive service. For example:

- **Schedule Agent:** MV Transit is not taking advantage of PASS’s ability to automate the scheduling of subscription trips. Once changes are made that result in a much higher level of satisfaction with Trapeze’s scheduling solutions, MV’s schedulers can more efficiently use Schedule Agent for the scheduling of subscription trips
- **Waitlist:** PASS includes a feature that helps reservation agents when no solution is found. Using Waitlist will show the reservation agent how many trips already exist in the times around the requested time, and will make it easier for the reservation agent to quote the caller an alternate time when trying to place the trip.

Figure 5-35 | DEFAULT Settings for Costing Weights

The 'Costing Weights' dialog box is titled 'Costing Weights' and features a close button (X) in the top right corner. It is divided into several sections:

- Importance Slider:** A horizontal slider at the top with '<< Less Important' on the left and 'More Important >>' on the right.
- Variables Section:**
 - 1 Second = 2.68 meters
 - 1 \$ = 1000 meters
 - Free DBT fact: 1.5
 - Free Pullouts: 66 %
 - OOw Extra: 1.24 dist.
 - DH Threshold: 15 time
- Scaling Section:**
 - Para: 100 %
 - FX: 100 %
 - Flex: 100 %
 - Taxi: 100 %
 - Bulk: 100 %
- Other Parameters:**
 - Min Distance: [Slider]
 - Min Run Time: [Slider]
 - Min OOw: [Slider]
 - Min TOOw: [Slider]
 - Min DBT: [Slider]
 - Max Same Geo: [Slider]
 - Min Backtrack: [Slider]
 - Min Pullout: [Slider]
 - Min Walking: [Slider]
 - Min Transfers: [Slider]
 - Min Violations: [Slider]
 - Min Req Dev: [Slider]
 - Load Balancing Threshold: [Slider]
 - Min Deadhead: [Slider]
 - Min Provider Cost: [Slider]
 - Min Taxi Garage Dist: [Slider]
 - Min Garage Pullout Slack: [Slider]
 - Min Garage Pullin Slack: [Slider]
 - Max Run Time Flexibility: [Slider]
 - Run Priority: [Slider]
- Buttons:** 'Use Defaults', 'Cancel', and 'OK' buttons are located at the bottom right.

Figure 5-36 | T Lift Settings for Costing Weights

The 'Costing Weights' dialog box is titled 'Costing Weights' and features a close button (X) in the top right corner. It is divided into several sections:

- Importance Slider:** A horizontal slider at the top with '<< Less Important' on the left and 'More Important >>' on the right.
- Variables Section:**
 - 1 Second = 2.68 meters
 - 1 \$ = 1000 meters
 - Free DBT fact: 1.5
 - Free Pullouts: 100 %
 - OOw Extra: 1.00 dist.
 - DH Threshold: 10 time
- Scaling Section:**
 - Para: 100 %
 - FX: 100 %
 - Flex: 100 %
 - Taxi: 100 %
 - Bulk: 100 %
- Other Parameters:**
 - Min Distance: [Slider]
 - Min Run Time: [Slider]
 - Min OOw: [Slider]
 - Min TOOw: [Slider]
 - Min DBT: [Slider]
 - Max Same Geo: [Slider]
 - Min Backtrack: [Slider]
 - Min Pullout: [Slider]
 - Min Walking: [Slider]
 - Min Transfers: [Slider]
 - Min Violations: [Slider]
 - Min Req Dev: [Slider]
 - Load Balancing Threshold: [Slider]
 - Min Deadhead: [Slider]
 - Min Provider Cost: [Slider]
 - Min Taxi Garage Dist: [Slider]
 - Min Garage Pullout Slack: [Slider]
 - Min Garage Pullin Slack: [Slider]
 - Max Run Time Flexibility: [Slider]
 - Run Priority: [Slider]
- Buttons:** 'Use Defaults', 'Cancel', and 'OK' buttons are located at the bottom right.

Revise Driver Manifests

The vehicles for all three services are not equipped with MDT/AVL (mobile data terminal/automatic vehicle location) equipment and so the drivers have no way to automatically time-stamp and location-stamp each arrival and departure. Instead, drivers record time and mileage information by hand on the driver manifests. The driver manifests for T Lift and NightLine are generated from Trapeze. The manifests for JayLift are generated through a Google spreadsheet.

Actual pick-up and drop-off times for T Lift and Night Line are manually entered into Trapeze by scheduler/dispatchers after the manifests are turned in. The driver manifest has two time points for pick-ups and one-time point for drop-offs. However, when there is only one time recorded per stop by a driver, there is some inconsistency among the drivers about which time point is recorded and some inconsistency among the dispatchers as to which field (arrival vs. departure) the time point is entered. Moreover, even when both actual arrival and departure times are recorded at a given stop, there is still some inconsistency among the drivers as to the time point that is recorded on the manifest. Some drivers do not record the actual arrival or departure time and instead record the passenger boarding or alighting time.

The way the manifests are structured, along with the inconsistency among drivers and dispatchers on how to record and enter time points, induces significant uncertainty into the performance metrics used to track and analyze paratransit and demand-response services at the CS. This is particularly important for on-time performance monitoring but can also affect other metrics, such as missed trips and excessively long trips. While the on-time performance for T Lift and Nightline is very good – for the calendar year 2015, reported as 92.9 percent for T Lift and 95.8 percent for Night Line from Trapeze’s On-time Performance Report – on-time performance may actually be a bit higher because of the inconsistent way in which drivers record arrival and departure times. Since JayLift trips are documented in Google and not in Trapeze, there is no automated tracking of on-time performance for JayLift.

The CS should revise the driver manifests for all three services to include an arrival and departure time at all stops, whether pick-ups or drop-offs. For the beginning of the run, drivers need only to fill-in the departure time from the yard, and at the end of the run, drivers need only to record the arrival time back at the yard. Drivers and schedulers should be instructed on how to record all times, and these should be entered into Trapeze. Though JayLift is manually scheduled through Google, times can still be entered into Trapeze and an on-time performance report generated, adjusting the time parameters to match the different pick-up window definition for JayLift.

Clarify Definition of On-time and Late Trips

The on-time and late trip definitions are primarily based on whether or not the van arrival time is within the +/- 15-minute pick-up window, noting that early arrivals are also considered as on-time. For T Lift and Night Line, late trips are defined as completed trips where the van arrival was beyond the pick-up window. However, there is no formal definition in the contract nor the customer information about a late trip also including arrivals at the destination beyond the specified appointment time or the requested drop-off time. At the same time, according to Trapeze’s On-Time Performance Report, about 3 percent of completed trips on T Lift were requested based on an appointment time or requested drop-off time, and despite the lack of a formal definition, it does appear that Trapeze is tracking the on-time performance of such trips versus the on-time performance for trips requested by pick-up time. So, it appears that the additional definition of a late trip has been entered into Trapeze and is used to track performance.

There are also some issues with the way on-time performance for JayLift is measured because of the lack of a formal pick-up window definition. MV management stated that the on-time pick-up window is 0/+5 minutes; MV's call center staff said there was no definition of a late trip; and KU staff indicated that the pick-up window might be the same as the T Lift pick-up window for trip origins beyond campus.

Clarifying the definition of on-time and late trips, by pick-up time and by appointment time or requested drop-off time, and defining the pick-up window for JayLift trips, will help the CS accurately track and monitor early, on-time, and late trips. Clearer patterns could emerge that can help managers, dispatchers, and schedulers make small changes to the system to improve productivity and efficiency.

Ensure Proper Performance Monitoring

Figure 5-37 includes performance metrics that the CS should track and analyze to better understand if there are patterns of paratransit and demand-response service characteristics that may point to a capacity constraint. Many are currently tracked by CS but some are improperly or not recorded or analyzed. In particular, it is the responsibility of the CS as the grant recipient to understand whether there is a capacity-induced pattern of late trips, trip denials, missed trips, excessively long trips, and hold times. Such patterns might point to certain passengers, certain areas within Lawrence, or certain times of day.

Reduce Night Line Costs

Night Line service is costly to provide, at over \$32 per trip compared to about \$25 per trip for T Lift Service. One approach to reducing costs would be to shift some Night Line service to a fixed-route or flex-route service based on an analysis of origins and destinations. While these services still tend to perform poorly compared to daytime service, they are generally less costly than full demand-response service if appropriately designed. However, implementing late-night fixed-route service still comes with an obligation to provide ADA paratransit service, so the costs associated with providing the ADA service may negate any cost benefits received from converting to fixed-route service. An additional approach would be to create a subsidy program involving both taxis and TNCs such as Uber and Lyft. This approach would not create any Title VI issues. The idea of a subsidy for rides provided by taxis is not a new idea, but the recent addition of TNCs to the market has made the approach more workable and less expensive.

LAWRENCE TRANSIT COA | SERVICE RECOMMENDATIONS

Lawrence-Douglas County MPO

Figure 5-37 | Demand-response Performance Metrics

| Metric | Definition | Industry Standards | Actual (CY 2015) and Notes |
|-------------------------------|---|---|--|
| On-time performance | For T Lift and Night Line: any occurrence where the vehicle arrives at the appointed location to provide a passenger within 15 minutes of the requested time. Early trips may be included in this definition if there is no driver coercion aimed at the rider to enter the vehicle before the beginning of the pick-up window. | 0-15 min: 90% 0-20 min: 92% 0-30 min: 95% | T Lift: 92.9% Night Line: 95.8% JayLift: N/A |
| Trip denials | A trip that cannot be accommodated because of inadequate system capacity. If a trip cannot be scheduled within one hour of the requested pick-up time, it is to be considered a denial, whether or not the customer agrees to an alternative pick-up time. If one of the legs cannot be provided and the customer does not want the trip, then it counts as two denials. | For ADA paratransit service there should not be a pattern of denials. For Night Line, denials are a function of limited capacity. | Denials are currently not being recorded nor analyzed to determine if there are any patterns. |
| Missed trips | Missed trips should be documented as instances when the vehicle fails to arrive to provide a scheduled trip, or when the vehicle arrives late (beyond the pick-up window), and the customer cannot be found or chooses to cancel at the door. (Such an instance that occurs within the pick-up window should be documented as a no-show or cancel-at-door, if tracked separately.) The CS definition of a missed trip is incorrect. CS has been defining missed trips as completed or uncompleted trips where the vehicle arrives 45 minutes after the confirmed pick-up time or never arrives. Missed trips should always be marked as uncompleted trips. | Industry standard is to keep these under 0.5% of the completed trips. | Some CS dispatchers are incorrectly documenting no-shows that occur after the pick-up window as no-shows. These should be recorded as missed trips. |
| Excessively long trips | A trip outside of the comparable time to an identical trip on the fixed-route system, within a reasonable threshold of time. FTA policy defines an excessively long trip as a trip time that exceeds the trip time on the fixed route system (at the time of the trip) plus 20 minutes (to account for walking and waiting time). The CS has specified 45 minutes in Trapeze as a scheduling parameter meaning that Trapeze will not schedule a trip (in batch or single insert mode) if it violates this parameter. Also, forcing in a trip that violates this parameter will result in a flagged violation. | The industry standard is to keep these under 0.5% of the completed trips. | A summary report on excessively long trips is not provided by Trapeze, nor is the CS checking to see whether or not there is a trip pattern that exceeds this violation. |

Coordination with Human Services Providers

In addition to T Lift and JayLift, there are several other demand response service providers in Lawrence and Douglas County (see Figure 5-38). While each of these Human Services Agency (HSA)-operated providers has specific eligibility requirements (in some cases broader, and in others more narrow, than T Lift), there are many similarities among them, and between them and T Lift, in terms of vehicle technology; dispatch, operations, and maintenance procedures; and even funding sources. As a result, there is a certain degree of redundancy and competition for resources that could be mitigated through closer regional coordination. In general, there are four coordination options that could be considered for demand response services in Lawrence:

1. **Lawrence Transit (or MV) purchases *dedicated* service from HSA operators.** HSA makes drivers and vehicles available for blocks of time to expand T Lift capacity at times when additional capacity for T Lift is needed. Lawrence Transit would reimburse HSA for service at an agreed-upon hourly rate that is lower than the existing hourly rate for T Lift service. This coordination strategy would provide an additional revenue source for the HSA(s) and would reduce the overall unit cost per trip for Lawrence Transit.
2. **Lawrence Transit (or MV) purchases *non-dedicated* service from HSA operators.** MV sends unscheduled and compatible trips to HSA, which schedules trips onto their own vehicles. Compatible ADA and HSA trips are co-mingled on HSA vehicles at a negotiated rate per trip (could also be mileage-based). As with strategy 1, this coordination strategy would provide an additional revenue source for the HSA(s) and would reduce the overall unit cost per trip for both Lawrence Transit and the HSA(s).
3. **HSA purchases Lawrence Transit service.** HSA replaces their own operation with purchased service from Lawrence Transit at an agreed-upon per trip rate. This is a traditional coordination strategy for HSAs that wish to not be in the transportation business but would likely only make sense for these agencies if it can lower their transportation costs. ADA and HSA trips would be co-mingled with service purchased either from Lawrence Transit or from MV. This coordination strategy would provide an additional revenue source for Lawrence Transit and would likely reduce the overall unit cost per trip for Lawrence Transit and possibly for the HSA(s).
4. **Lawrence Transit to provide Travel Training Services for T Lift users and to partnering HSAs.** This is primarily a mobility management strategy, but coordination does apply if the partnering HSAs are also willing to share in the travel training costs. The concept here is that there is a family of different types of travel training efforts that Lawrence Transit can provide to HSA customers. These range from more intensive one-on-one travel training (typically for persons with developmental/cognitive/intellectual disabilities) to group travel training/navigational assistance (typically provided to seniors) and bus buddies (seniors and person with disabilities). All of these are proven strategies to enable persons who are able to use the fixed-route system for one or more trips to learn how to use a particular route or the system for some or all of their travel needs. This strategy is designed to “divert” person trips from higher unit cost paratransit services to lower unit cost fixed-route services, thereby reducing the paratransit demand and total paratransit subsidy while enabling individuals to travel more independently (and without having to plan for the trip in advance). Lawrence Transit could provide these services for free to HSAs, or it could explore cost sharing arrangements where the partnering HSAs shares the cost of the travel training.

LAWRENCE TRANSIT COA | SERVICE RECOMMENDATIONS
Lawrence-Douglas County MPO

Figure 5-38 | Lawrence-Douglas County Regional Provider Service Characteristics

| Provider | Service Type | Eligibility | Schedule | Service Area/Coverage | Fare | Ridership (2015) |
|---|--------------------------------|--|-------------------------------------|-------------------------------------|--|------------------|
| Babcock Bus (Lawrence-Douglas County Housing Authority) | Demand-response (door-to-door) | Elderly and disabled residents of Peterson Acres/Babcock Place | Monday – Thursday (8 AM – 4 PM) | City of Lawrence | \$3 round-trip fare suggested | 2,247 |
| Bert Nash Community Mental Health Center | Demand-response (door-to-door) | Elderly and disabled patients | Monday – Saturday (9 AM to 7 PM) | Douglas County | No charge | 4,020 |
| Cottonwood, Inc. | Demand-response (door-to-door) | Adults with intellectual development disabilities | Monday – Sunday (7 AM to 10 PM) | City of Lawrence | \$50 monthly transportation fee | 2,948 |
| Senior Resource Center for Douglas County, Inc. (SRC) | Demand-response (door-to-door) | Older residents (60+) | Monday – Friday (7 AM – 3:40 PM) | Douglas County | One-way within Lawrence: \$4; round-trip within Lawrence: \$8; one-way outside Lawrence: \$6; round-trip outside Lawrence: \$12* | 6,397 |
| Independence, Inc. | Demand-response (door-to-door) | Elderly and disabled individuals | Monday – Friday (8 AM – 5 PM) | City of Lawrence and Douglas County | One-way within Lawrence: \$3; one-way within Douglas County: \$5; \$30 to medical centers in KC and Topeka | 6,808 |

*A short application is required. Rates can be adjusted for clients in need.

Recommendations

The HSAs interviewed for this study fall into two categories: HSAs who provide services to persons with developmental/cognitive/intellectual disabilities; and those who provide service to seniors.

In the case of HSAs who focus on the provision of mental health services and which also operate transportation, they indicated that those customers who can use T Lift – and are deemed eligible – are already using T Lift, and those who require a higher level of assistance use the HSA-operated service. The HSAs interviewed also expressed a concern over privacy and confidentiality. Thus, strategies 2 and 3, where co-mingling would occur and where a higher level of assistance is required, may not make sense.

Some HSA providers indicated that their vehicles are occasionally not in use and thus could theoretically be used by other providers (although rarely), but no HSA providers have drivers available to operate the vehicles during times when they are not in use, as the drivers have other agency duties. For these reasons, we do not believe that strategy 1. makes sense, except as a possible back-up if the number of T Lift vehicles falls below what is required for pull-out, but at this time that does not appear to be a problem. Strategy 4. holds much promise, however, and for the reasons discussed above should be pursued. Moreover, the mental health HSAs interviewed for this study expressed an interest in this strategy.

Lawrence Transit should pursue strategy 4 with the HSAs that provide mental health services. As part of the discussion and planning, Lawrence Transit planners and the HSA staff can discuss how well the current routes and timetables currently meet the needs of HSA customers and whether minor route adjustments or improvements to bus stops would increase transit use. We suggest that Lawrence Transit develop a full-scale family of travel training services, in consultation with the HSAs, document the results, and then perhaps seek cost-sharing arrangements as benefits can be documented. In addition, there are now apps that can help with this target population in using GPS-enabled transit buses.

In the case of Senior Resource Center for Douglas County, Inc. (SRC), management indicated an interest in exploring all four strategies. ADA/senior coordinated services are very common across the US and fall under the first three coordination strategies, in cases where unit costs per trip can be lowered for both the transit agency and for the senior service agencies. **Lawrence Transit should meet with SRC to discuss consolidation/coordination options and to explore whether these strategies would reduce the unit cost for both parties.**

SRC management also indicated an interest in travel training for its seniors. Here, Lawrence Transit could provide several types of training. Most appropriate would be group travel training provided to groups at senior centers and senior residences. Lawrence Transit could also train designated “mobility specialists” at each center or residence, and assist SRC with establishing a bus buddy program of volunteer senior bus buddies. Lastly, Lawrence Transit and SRC can discuss whether or not one-on-one intense training is appropriate to any adult day health customers. **Lawrence Transit should meet with SRC to discuss the implementation of a comprehensive travel training program. Lawrence Transit should seek grants to establish such a program; provide these services for free to SRC, and then later explore a cost sharing arrangement as benefits are documented.**

6 FARES, FUNDING, AND GOVERNANCE

OVERVIEW OF EXISTING SYSTEM

Fares

Lawrence Transit and KUOW have a unified fare structure. The regular cash fare on the fixed routes of both systems is \$1.00, which also allows free transfers. KU students, staff, and faculty ride fare-free on all routes when showing KU identification. Service is fare-free for all riders within the KU campus zone. Fare-free service for KU affiliates is funded through a student fee and pre-paid by KU. Although the fare-free service extends to KU staff and faculty, these affiliates do not currently contribute funding for the privilege. All children aged 5 and under also ride free.

For riders who are not students and would otherwise pay the \$1.00 cash fare per trip, there are one-day passes available for \$2.75, 10-ride cards for \$10.00 (no discount from single-ride price but eliminates the need to carry cash for each trip), and monthly passes for \$34.00. These products are sold at City Hall and at participating grocery stores. A 50 percent discount is given to certain qualifying individuals for both fares and passes.

T Lift service costs \$2.00 per trip, or \$20.00 for a 10-ride card. Monthly passes on T Lift cost \$68.00. In order to be eligible for T Lift, a medical provider must certify that the person is unable to use the fixed-route system. JayLift paratransit service is available to those who are affiliated as students, staff, or faculty of KU at no cost. The Night Line demand-response service, available after standard working hours, costs \$2.00 per trip, with no passes being accepted.

Governance

Lawrence Transit is one of the department functions of the City Manager's Office. The Public Transit Administrator is responsible for the overall management of the system. Policies for Lawrence Transit are set by the Lawrence City Commission. A nine-member Public Transit Advisory Committee (PTAC) provides advice on all matters regarding the system including service changes, ridership policies, fare structure, funding, and budgets. The nine members serve three year terms and are comprised of volunteers appointed by the Mayor.

KUOW is a function of the University's Department of Parking and Transit. The Associate Director of Parking and Transit serves as the administrator of KUOW. A ten-member Transit Commission appointed by the Provost oversees KUOW and advises the Provost on transit matters. Recommendations to the Provost for membership on the commission are made by the Student Senate (7 seats); Staff Governance Committee (2 seats) and Faculty Governance Committee (1 seat). Typically, the Provost accepts Transit Commission recommendations; however, the Provost makes the final decision.

The City and University operate a unified system by coordinating services and functions. The City and University signed a Memorandum of Understanding (MOU) Concerning Transit Facility and Bus Acquisitions and a facility lease agreement in 2010. These documents define the use and cost sharing for the shared transit facility and procurement of transit vehicles. A Memorandum of Agreement (MOA) for Coordinating Transit Operations was signed in 2013 to further document the partnership. The 2013 MOA notes that the City and University will endeavor to continue to utilize the same contractor to operate transit services and will coordinate in the negotiation of future contracts for transit operations.

The 2013 MOA also defines the terms of the coordinated routes allowing the City and the University to negotiate the appropriate cost allocation percentages. The agreement does not indicate how often the cost share allocations should be revisited, nor the basis for the cost share.

The City and University leadership fully embrace this ongoing coordination. They recognize the many benefits that coordination provides including the elimination of overlapping services. This approach enables service hours to be deployed in a manner that provides better frequency and connection opportunities for both the University community and the city at large. Other benefits of the coordinated system include a unified fare structure for both services; efficiencies from having a single maintenance facility and service contractor; and the ability to submit joint grant applications.

Funding

Funding for the operation of Lawrence Transit is provided by passenger fares, a small amount of student fees, a dedicated sales tax, FTA 5307 formula funds, and state assistance. Figure 6-1 presents the mix of funding sources for Lawrence Transit over time. Since 2009, state funding support has increased from \$128,287 in 2009 to \$507,030 in 2015, due to a formula which reflects ridership, population, and amount of service. This funding has been critical to meet the service needs of the system. In 2015, state and federal funding met 48 percent of operating expenses, while farebox revenues contributed 8 percent and local sales tax revenues were 44 percent.

Figure 6-1 | Lawrence Transit Funding Sources (2009-2015)

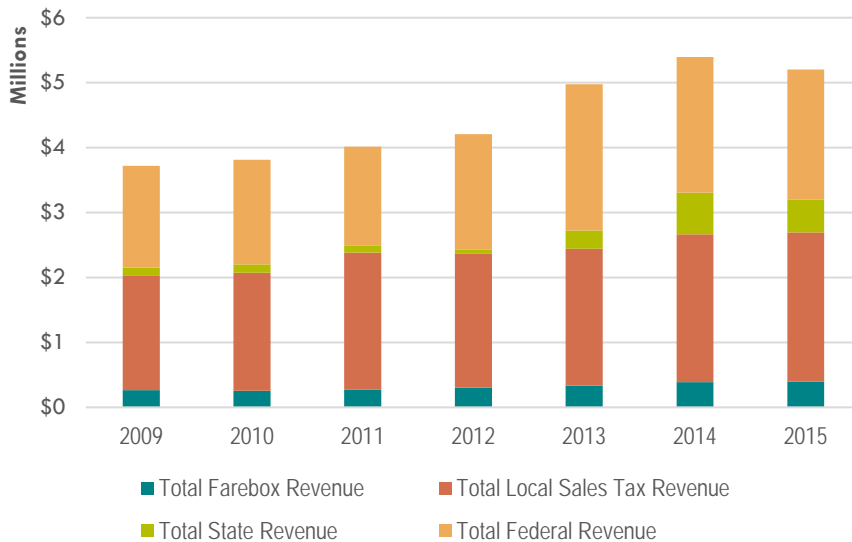

In 2008, the voters of the City of Lawrence approved two sales taxes for transit. One was a 0.20 percent sales tax to sustain existing services, while the second was a 0.05 percent sales tax to fund new services. Both of these taxes are set to expire at the end of 2018. The City opted to hold the revenues from the 0.05 percent tax in reserve to fund the local match for a new transit center. However, in fiscal year 2015, the City began using funds from this tax to expand bus service.

There are three student fees that provide funding for the KU system. One fee supports the operation of KUOW and Jaylift complementary paratransit service. Another fee is established to acquire vehicles. The third fee funds SafeRide and SafeBus services. These fees must be approved annually by the Student Senate and changes to the fees need to be voted on by the student body.

The student fee covers 70 percent of the operating budget for KUOW. The other 30 percent is funded by parking revenues since KUOW provides service from distant parking lots not within walking distance of all campus facilities.

PEER SYSTEMS

The study team, together with Lawrence Transit and KUOW, identified a set of transit systems with similar characteristics and operating environments to Lawrence’s. The peers generally have metropolitan areas and transit systems that are close in size to Lawrence Transit and mid- to large-size universities with student and staff populations comparable to the University of Kansas. Figure 6-2 lists each peer and the characteristics that make the transit systems similar to Lawrence. Only transit service reported to the National Transit Database is included below – some universities with their own transit systems do not report to NTD, especially if they do not receive any federal funding from FTA.

Figure 6-2 | Lawrence Peer Communities and Transit Systems

| City | Service Provider | University | Service Area Population | University Population | Univ. Pop. as % of Service Area** | FR Vehicles Operated in Max. Service |
|---------------|--|---------------------------|-------------------------|-----------------------|-----------------------------------|--------------------------------------|
| Muncie, IN | Muncie Indiana Transit System | Ball State University | 70,085 | 25,473 | 36% | 26 |
| Ames, IA | Ames Transit Agency dba CyRide | Iowa State University | 58,100 | 38,505 | 66% | 74 |
| Lafayette, IN | Greater Lafayette Public Transportation Corporation | Purdue University | 134,333 | 42,464 | 32% | 50 |
| Normal, IL | Bloomington-Normal Public Transit System | Illinois State University | 129,107 | 24,351 | 19% | 23 |
| Athens, GA | Athens Transit System/University of Georgia Transit System | University of Georgia | 119,980 | 46,500 | 39% | 67* |
| Iowa City, IA | Iowa City Transit/University of Iowa | University of Iowa | 71,372 | 34,446 | 48% | 47* |
| Columbia, MO | City of Columbia | University of Missouri | 121,351 | 51,630 | 43% | 28 |

LAWRENCE TRANSIT COA | FINAL REPORT
Lawrence-Douglas County MPO

| | | | | | | |
|---------------------|--|------------------------------|---------------|---------------|------------|------------|
| Bloomington, IN | Bloomington Public Transportation Corporation | University of Indiana | 80,405 | 50,663 | 63% | 30 |
| Chapel Hill, NC | Chapel Hill Transit | University of North Carolina | 80,218 | 41,067 | 51% | 76 |
| Missoula, MT | Missoula Urban Transportation District/The University of Montana (ASUM Transportation) | University of Montana | 70,868 | 13,753 | 19% | 27* |
| Harrisonburg, VA | City of Harrisonburg Department of Public Transportation | James Madison University | 53,491 | 22,248 | 42% | 31 |
| Fargo, ND | City of Fargo, dba Metropolitan Area Transit | North Dakota State | 134,149 | 16,963 | 13% | 23 |
| <i>Peer Average</i> | | | <i>93,622</i> | <i>34,005</i> | <i>39%</i> | <i>40</i> |
| <i>Lawrence, KS</i> | <i>Lawrence Transit/KU on Wheels</i> | <i>University of Kansas</i> | <i>87,643</i> | <i>30,754</i> | <i>35%</i> | <i>37*</i> |

*University and Municipal Transit Systems' combined values **Service Area and University figures from different sources, not always comparable

PERFORMANCE METRICS BENCHMARKING

Lawrence Transit and its peer systems were compared in terms of select performance metrics. Data was collected from the National Transit Database (NTD) based on 2015 reporting data, so the data for Lawrence include both Lawrence Transit and KUOW. Figure 6-3 shows how transit service in Lawrence compares to each of the selected peer communities across a number of measures of service performance and efficiency. Data below is for fixed route service only.

Figure 6-3 | Peer Transit Service Benchmarking – Fixed Route Service Only

| City | Passengers per Revenue Hour | Cost per Passenger Trip | Cost per Revenue Hour | Farebox Recovery %** | % Admin Expenses |
|-----------------|-----------------------------|-------------------------|-----------------------|----------------------|------------------|
| Muncie, IN | 32.5 | \$2.77 | \$89.98 | 4% | 23% |
| Ames, IA | 54.6 | \$1.38 | \$75.08 | 48% | 15% |
| Lafayette, IN | 37.7 | \$2.11 | \$79.77 | 27% | 21% |
| Normal, IL | 29.1 | \$2.97 | \$86.33 | 17% | 15% |
| Athens, GA* | 73.1 | \$0.87 | \$63.67 | 82% | 16% |
| Iowa City, IA* | 52.1 | \$0.12 | \$66.85 | 35% | 10% |
| Columbia, MO | 21.0 | \$3.45 | \$72.23 | 29% | 21% |
| Bloomington, IN | 37.0 | \$1.84 | \$68.11 | 25% | 11% |
| Chapel Hill, NC | 42.2 | \$2.39 | \$100.84 | 62% | 14% |
| Missoula, MT* | 23.9 | \$3.40 | \$81.19 | 18% | 25% |

| | | | | | |
|----------------------|-------------|---------------|----------------|------------|------------|
| Harrisonburg, VA | 46.8 | \$1.26 | \$59.00 | 48% | 11% |
| Fargo, ND | 20.9 | \$3.53 | \$73.92 | 11% | 26% |
| <i>Lawrence, KS*</i> | <i>30.4</i> | <i>\$1.91</i> | <i>\$58.11</i> | <i>45%</i> | <i>13%</i> |
| Average | 37.2 | \$2.15 | \$75.01 | 35% | 17% |

*University and Municipal Transit Systems' combined values **Farebox recovery includes university fees paid in lieu of fares per NTD procedures

Productivity and Expenses

With regard to passengers per revenue hour, Lawrence is below the average of its peers. This may indicate that it serves a greater proportion of non-university trips, since colleges often have higher ridership than surrounding areas. Nevertheless, improving ridership is one important goal of the service redesign described earlier in this report. Implementation of the service recommendations will likely bring Lawrence Transit closer to the peer average for ridership per hour.

Lawrence is somewhat less than the peer average for cost per passenger trip. This reflects the offsetting effects of the unfavorably low ridership and the favorably low expenses per hour. Again, the service recommendations in this study should help to further improve the cost per passenger, since overall costs are expected to remain neutral while ridership is expected to increase.

For costs per revenue hour, Lawrence is well below the average of the peer agencies. To a small degree, this may be due to a lower cost of living in the Lawrence area. However, generally these lower costs appear to reflect a system which is efficiently operated, with good procurement practices for operating and maintenance contracts. The long history of collaboration between Lawrence Transit and KUOW, including both service planning and operations, surely has helped to keep these costs low.

Since university fees count toward farebox revenue, the farebox recovery ratio for the two Lawrence systems combined exceeds the peer average somewhat. Although some of the funding streams are uncertain, at this point in time Lawrence is generally in line with similar cities regarding the proportion of funding provided by fares and university fees.

Administrative Costs

Lawrence devotes a smaller than average portion of its overall operating expenses to administrative costs. As with the low overall costs noted above, this indicates an efficiently managed operation. Once again, the collaboration between the two systems appears to contribute to reduced costs.

Fares for Peer Systems

Figure 6-4 on the following page shows current fares for the peer systems identified above. There are two systems which operate completely fare-free (Missoula and Chapel Hill). For the remainder, the regular fixed-route fare ranges from \$0.50 to \$1.75, with Lawrence toward the lower end of this range at \$1.00. Where there is a separate university transit system, it is common for these routes to operate fare-free.

Paratransit eligibility procedures are generally similar to Lawrence, although two universities require an in-person assessment (University of Iowa and University of Georgia). This requirement is more easily met when a campus has a medical facility where individuals can be evaluated.

LAWRENCE TRANSIT COA | FINAL REPORT
Lawrence-Douglas County MPO

Figure 6-4 | Fare Comparison of Peer Systems

| City | Service Provider | Fixed-route Fare* | Reduced Fare | Paratransit Provider | Paratransit Fare | Paratransit Eligibility Process |
|-----------------|--|--|--|---|--|---|
| Muncie, IN | Muncie Indiana Transit System | \$0.50 | \$0.25 | MITSPPlus | \$1.00 | Determined by questioning a professional who is familiar with applicant's abilities. |
| Ames, IA | Ames Transit Agency dba CyRide | \$1.25 | \$0.60 | CyRide Dial-a-Ride | \$2.00 | Applicant must complete ADA application. Agency may follow up with applicant or physician. |
| Lafayette, IN | Greater Lafayette Public Transportation Corporation | \$1.00 | \$0.50 | ACCESS | \$2.00 | Applicant must complete ADA application, which includes physician verification. |
| Normal, IL | Bloomington-Normal Public Transit System | \$1.00 | \$0.50 | Connect Mobility | \$2.00 | Applicant must complete ADA application. |
| Athens, GA | City: Athens Transit System / University: University of Georgia Transit System | City: \$1.75 / University: Fare-free | City: \$1.00 / University: Fare-free | City: The Lift / University: Disability Van | City: \$3.50 / University: Fare-free | City: Applicant must complete ADA application, which includes physician verification / University: Established through evaluation at the Disability Resource Center. |
| Iowa City, IA | City: Iowa City Transit / University: University of Iowa | City: \$1.00 / University: Fare-free | City: \$0.50 / University: Fare-free | City: SEATS / University: Bionic Bus | City: \$2.00 / University: Fare-free | City: Applicant must complete ADA application, which includes physician verification / University: Established through evaluation by the Dispatch & Bionic Supervisor and CAMBUS manager. |
| Columbia, MO | City of Columbia | \$1.50 | \$0.75 | COMO Connect Paratransit | \$2.00 | Applicant must complete ADA application, which includes physician or other medical professional verification. |
| Bloomington, IN | Bloomington Public Transportation Corporation | \$1.00 | \$0.50 | BTaccess | \$2.00 | Applicant must complete ADA application, which includes physician or other medical professional verification. |
| Chapel Hill, NC | Chapel Hill Transit | Fare-free | Fare-free | EZ Rider | Fare-free | Applicant must complete ADA application, which includes physician or other medical professional verification. |

LAWRENCE TRANSIT COA | FARES, FUNDING, & GOVERNANCE

Lawrence-Douglas County MPO

| | | | | | | |
|------------------|--|---|---|--|---|--|
| Missoula, MT | City: Missoula Urban Transportation District / University: The University of Montana (ASUM Transportation) | City: Fare-free / University: Fare-free | City: Fare-free / University: Fare-free | City: Mountain Line Paratransit Services / University: N/A | City: Fare-free / University: N/A | City: Applicant must complete ADA application, which includes physician or other medical professional verification. In some cases, follow up phone conversation, or in-person meeting or functional assessment used for additional eligibility information / University: N/A |
| Harrisonburg, VA | City of Harrisonburg Department of Public Transportation | \$1.00 | \$0.50 | Harrisonburg Paratransit | \$2.00 | Applicant must complete ADA application, which includes optional physician or other medical professional verification. |
| Fargo, ND | City of Fargo, dba Metropolitan Area Transit | \$1.50 | \$0.75 | MAT Paratransit | \$3.00 | Applicant must complete ADA application, which includes name of a social worker or medical professional. |
| Lawrence, KS | Lawrence Transit | \$1.00 | \$0.50 | T Lift | \$2.00 | Applicant must complete ADA application, which includes physician or other medical professional verification. |

*All fixed-route systems have free transfers.

PEER REVIEW

A subset of the peer transit systems and universities were selected for a more in-depth review for their similarity to Lawrence. Interviews with each agency investigated their operating agreements, fare structure, and governance models to identify best practices relevant to Lawrence. The results of the interviews are summarized here and informed the recommendations later in the report.

Ames, Iowa

CyRide is the transit system providing service within the City of Ames and began in 1976 with fixed-route and dial-a-ride service owned and operated by the City of Ames. In 1981, the system was moved into a new agency funded jointly by the City of Ames and Iowa State University (ISU). It was a student idea to create a combined city/university transit system to serve the community. Technically, CyRide is an agency of the City and employees are employed by the City. However, service changes are made with significant input from students and members of the community.

CyRide has a unique governance structure with equal representation between the city, the university, and students on the governing board, which is detailed in city code. The six members of the board are the Ames City Manager, an Ames City Council member, a citizen appointed by the mayor, ISU's Vice President of Business and Finance, and two ISU students.

The governance structure has generally worked well for the system, but some challenges exist. Student member terms are just one year, so there is continuous turnover in board members and a learning curve for new members. There is also debate about what the "right" mix of city, student, and university funding should be. While there are no officially designated university or city owned routes, the board increasingly refers to different routes as serving either the community, students, or university faculty and staff and using ridership and service levels on these routes to determine each parties' annual funding. Generally, the city and university pay the same share, with the cost of service increases borne by the students as university enrollment has increased.

Regular fare is \$1.25 and the transit system is free for all ISU students to ride. In addition, the University subsidizes 30 percent of faculty and staff monthly transit passes so they cost about 70 percent of the regular rate.

The system has steadily expanded and now carries over 6 million passengers per year; about 93 percent of riders are ISU students. System and ridership growth has been due to a mix of factors, including strict parking management policies, increasing university enrollment, and increasing service levels that make the system more attractive for students. Additional factors contributing to the ridership growth on CyRide are the decentralized campus with ISU buildings throughout Ames rather than within a core campus, and many students choosing to live off campus. Due to these factors and ISU's parking controls, students must therefore use the bus system not only to travel between classes, but also to travel to and from their classes.

Chapel Hill, North Carolina

Chapel Hill Transit (CHT) is the transit system serving Chapel Hill and Carrboro, North Carolina providing fixed route and paratransit services known as EZ Rider. The system has seen its most notable expansion over the past decade, beginning with its switch to a fare-free system in 2002, with the exception of two routes where fares remain. Since implementing the fare-free system, annual ridership has doubled from 3.5 million to 7 million. The University of North Carolina – Chapel Hill has also fed CHT's expansion through its own growth.

CHT offers services seven days a week, with 24 routes operating on weekdays, eight on Saturdays, and two campus circulators on Sundays. The system is oriented toward the UNC campus and downtown Chapel Hill, with almost every route passing through or near campus. Approximately 60 percent of CHT's ridership is made up of UNC and UNC Health Care students, faculty, and staff. In addition to the free fare, the UNC population's high ridership can be partially explained by a limited supply of parking on and near campus, encouraging alternative forms of transportation.

CHT's unique funding arrangement is among the system's main contributors to the ability to remain fare-free. CHT's operating revenues are provided by partner contracts with the Town of Carrboro and UNC, as well as funding contributions from the Town of Chapel Hill. These three entities provide roughly 66.5 percent of the system's operating and capital resources. The Town of Carrboro funds CHT through general fund resources, providing 7.5 percent of CHT's funding and the Town of Chapel Hill raises transit funds through a property tax, providing 21 percent of total funding. UNC provides roughly 38 percent of CHT revenues, which are paid for in part by the Student Transit Fee included in student tuition. The Student Transit Fee pays for access to and around campus for students and largely reflects a "pre-paid" transit fee for students, faculty, and staff at UNC.

The fare-free system is also supported by the local government and residents of both Chapel Hill and Carrboro committing to public transportation as part of their local growth strategies.

Columbia, Missouri

COMO Connect is the transit system in Columbia Missouri. Regular one-way fare is \$1.50 and day passes are \$3.00. In addition, the City offers half fares for pre-approved customers and a semester pass for \$100 for students. The transit agency raised fares from \$1.00 to \$1.50 in 2012, which reduced ridership somewhat. Paratransit fares are \$2.00.

While transit services have been provided in the city since 1965, in 2013 the city council adopted the COMO Connect transit improvement plan, which introduced a new networked route system and name/branding. Instead of the previous orbital pulse system, COMO Connect has routes circulating customers into core connector routes that better serve the Columbia public. University students also benefitted from the change as the new service routes focus on serving campus as the largest town employer and connecting off-campus student housing to campus.

The University of Missouri has an intergovernmental cooperative agreement with COMO Connect to provide transit services serving University students called the Tiger Line. COMO Connect provides parking shuttle services from satellite parking lots into campus core and paratransit services for students and faculty. The transit agency also provides two evening shuttles around campus, a shopping shuttle, and a downtown shuttle in the evening and on weekends. Tiger Line routes are integrated into COMO Connect service planning and displayed alongside community routes on the city's live bus tracking system.

Tiger Line is available when classes are in session during fall and spring semesters, with limited service available during registration. The Tiger Line is free and buses are open to both students and the public. Tiger Line buses are equipped with GPS and can be tracked in real time using the Go Mizzou smart phone app.

The cooperative agreement details the methodology for determining the annual cost to the University for this service through an hourly rate of service. Last year, the University of Missouri

paid \$1.2 million to the transit agency to operate the Tiger Line, roughly \$23 per student per semester. The cooperative agreement does not include the University participating or buying services from the fixed route service, however, the University Parking and Transportation Manager sits on the public transit advisory commission.

Fargo, North Dakota

The Metropolitan Area Transit System or MATBUS is the public transportation system serving Fargo and West Fargo in North Dakota, and Moorhead and Dilworth in Minnesota. The system is operated by the cities of Fargo and Moorhead who work together to ensure comprehensive service in the region. MATBUS operates 25 fixed routes Monday through Saturday connecting key destinations, as well as operating circulator buses on North Dakota State University (NDSU) campus during the school year.

MATBUS' U-Pass Program offers unlimited free rides to college students from NDSU, Minnesota State University - Moorhead (MSUM), Concordia College, and Minnesota State Community and Technical College. These colleges and universities pay a fee based on operating costs per student rider to MATBUS to participate in the U-Pass program. For the past four years, the fee has been \$6 per student per year, roughly equal to the operating costs per rider. In addition, NDSU pays an additional \$6,000 per year for their faculty and staff to also ride fare free.

MATBUS and NDSU signed a joint powers agreement in 2001, which specifies that the university pays the operating cost of campus circulator buses through an annual donation to MATBUS from the school's administrative budget. NDSU does not currently have a dedicated student fee for transit, but the university is actively considering it. NDSU contributed funding for the local match to purchase five new buses in 2007.

U-Pass riders do not need a special pass but use their student ID at the farebox. MATBUS upgraded their buses with GSI farebox technology that can read a chip in the student's ID to get a more accurate count of student passengers. The agency uses this information to validate their university cost sharing estimates. While the current farebox technology does not determine if the student ID presented is valid/active, other communities have integrated this data to ensure students are currently enrolled and MATBUS is considering moving to this system.

U-Pass riders comprise about 50 percent of MATBUS system ridership. This proportion has remained steady for the past five years with steady ridership increases driven by the agency's marketing efforts and data-driven service improvements, as well as decisions by the University to locate three new campus facilities in downtown Fargo, with limited parking available on site. NDSU pays a reduced rate for full wrap advertising marketing on ten buses, and MATBUS recently relocated the transit system's main transfer hub onto NDSU's campus to be in a more convenient location for students.

MATBUS works with the local colleges and universities to provide targeted marketing for students about routes, fares, and services. The transit agency also provides live bus tracking through its mobile app, and the U-Pass site includes information on routes to common student destinations as well as marketing videos.

MATBUS does not have cost sharing or coordination with NDSU for paratransit services, but are aware of the NDSU disability services office. MATBUS serves students and university staff that qualify. However, this is not a large part of their paratransit service ridership, in part because all fixed-route buses are accessible.

Missoula, Montana

Transit services in Missoula are provided by two separate systems. The Mountain Line is the transit system for the city, while the University of Montana also provides a student-run, on-campus bus service for students.

Since January 5, 2015, the Mountain Line has operated fare-free. The three-year pilot project is supported by a group of community partners including: The University of Montana, Associated Students of the University of Montana, City of Missoula, County of Missoula, the Missoula Metropolitan Planning Organization, St Patrick Hospital, Community Medical Center, Missoula County Public Schools, Missoula Aging Services, Missoula Downtown Association, Missoula Parking Commission, Missoulian, Southgate Mall, Destination Missoula, and Homeward, Inc.

There are Memoranda of Understanding with each community partner in place to document the level of funding that will be provided to the transit agency to make up for the lost farebox revenue. The University of Montana currently provides about \$150,000 per year, about one third of the total \$450,000 in community partner support per year.

Along with the addition of a second high-frequency BOLT! Route 2 and Late Evening Service, the community partnership goal was to increase ridership at Mountain Line 45 percent within the three years. Since launching the pilot, the Mountain Line has seen a 53 percent increase in ridership, exceeding expectations. Prior to the pilot, fares were \$1.00. Paratransit services are provided by the Mountain Line and are also fare-free during the pilot.

Normal, Illinois

Connect Transit provides transit service in Normal and operates routes serving students and staff on the Illinois State University (ISU) campus. Connect Transit and ISU have had a Memorandum of Understanding in place since 2004 which provides an operating cost sharing agreement, but does not detail exactly how it is to be calculated. ISU does not fund capital costs. ISU students, staff, and faculty ride all fixed-route Connect Transit buses for free; regular fares are \$1.00 for fixed routes and \$2.00 for paratransit services.

Connect Transit operates the Redbird Express, which provides specially branded transit services around Illinois State University (ISU) campus, Monday through Sunday, from 7:00 AM to 3:00 AM during the fall and spring semester on all regularly scheduled class days. This service is also free to all faculty, staff, students, and visitors when they show their valid University ID card.

Connect Transit began collecting data on ISU University ID cards used at fareboxes in June 2016 and hopes to use this data to update the University cost sharing MOU. Currently about 40 percent of all Connect Transit riders are students, and the agency expects this share to increase when new service changes take place that will make it more convenient for students to use the system.

ISU funding for Connect Transit comes from student fees, which are not dedicated solely to transit. Both the university and transit agency characterize the relationship as cooperative, although both would like to know more about each other's financial situation. Neither is convinced that the current cost allocation is optimal, although the new farebox data should help in the future. This indicates that it is best to include as much detail as possible in MOUs regarding revenue and cost sharing. There have also been some disagreements regarding routing and scheduling for campus routes, especially with a recent service redesign. These discussions about service may be integrated into the cost-sharing agreement as well.

ADMINISTRATIVE AND REVENUE CONTROL PROCEDURES

Counting cash is not a core capability for transit agencies, and therefore expertise in revenue control does not generally exist throughout the organization. This can lead to revenue loss, negative publicity, and undermining of public confidence. Some concern has been expressed that the existing facilities and procedures for counting cash at Lawrence Transit could be improved. Vendors who specialize in cash management can often provide this service better, as compared to keeping this function in-house. Many armored car and security companies can tailor a program designed to fit the needs of the agency, for cash transport, reconciliation, and deposit. The vendors can usually offer great flexibility regarding the frequency, timing and location of cash pickups, and they are experts at designing appropriate audit and security procedures. The additional cost for outsourcing this function is factored into our recommendations at the end of this section, although there may also be offsetting savings from the ability to repurpose or reduce in-house staff. As one example, the MBTA in Boston recently outsourced their cash management after a comprehensive review.

Regarding passes sold at grocery stores and other retail outlets, a cash management vendor can also assist with revenue control and auditing for these products. Alternatively, in-house staff can increase the oversight of the pass system. Each retail outlet should have control procedures, and a chain of responsibility for the cash and passes. All transit products should have unique serial numbers, and should be issued in blocks of consecutive numbers where possible, in order to facilitate auditing. All pass sales should be recorded with an audit trail. Additional potential audit/control procedures include:

- Randomly checking passes used on buses in order to insure that revenue from those passes was properly received,
- Randomly checking the passes being issued at the point of sale for conformity to expectations,
- An analysis of trends among pass sales at retail locations for anomalies, and
- A method for people to report suspected theft or fraud anonymously.

TITLE VI, EQUITY, AND FARE IMPACT TO PARTICULAR CUSTOMERS

The results from more than 1,000 survey responses received online and onboard buses over the course of this study provided demographic information, along with the method of payment for respondents' most recent transit trip. It should be noted that a significant percentage of respondents received a free fare with a KU card, and also that many respondents did not answer the question about household income. Nevertheless, once those with KU cards are excluded, people who had a household income of under \$10K were somewhat more likely to pay with cash than the respondents as a whole (67 percent vs. 62 percent). For future fare increases, this indicates that pass prices should be raised at least proportionally with cash fares. In order to ensure equity when prices change, it is suggested that the existing multiple of single-ride fares (which is currently 34) for monthly passes be maintained, but that the monthly pass price is then always rounded up to the nearest dollar.

FARE PAYMENT AND COLLECTION TECHNOLOGIES

A growing number of options for transit fare collection have emerged over the past decade. Today, advancements in mobile phone technology, banking, and payment systems have made methods for paying a fare more numerous than they have ever been before.

Allowing more choices for purchasing and paying fares can attract riders (especially younger people who are more accustomed to innovative payment options for other goods and services) and can reduce dwell times and, therefore, speed up service. Adding new payment options can be appropriate when fare equipment needs to be replaced or when an opportunity is presented for new partnerships with retail establishments, institutions, other transit agencies, or vendors like mobile payment providers.

Technology's Role in Fare Alternatives

While technology has changed rapidly, new approaches to fare payment should follow and support the fare policies and products of a transit agency. Implementation of new approaches must have the following considerations:

- **Operations:** How will the new technology impact dwell time, driver enforcement, and fare evasion?
- **Planning:** Are there new opportunities for ridership and revenue data as a result of the technology?
- **Distribution:** How will the fare media be distributed? What are the options for fare card outlets, ticket vending machines, online portals, etc?
- **Maintenance:** What is the cost to maintain fareboxes and supportive networks?
- **Costs/Revenues:** What is the cost of fare collection? Are there opportunities to increase revenue?
- **Customer Experience:** What's the quality of the customer experience in terms of ease of payment, convenience, and customer support?

Fare Collection Technology

The following section surveys fare collection technologies that are in use at select transit agencies along with the trade-Offs associated with each technology.

Magnetic Stripe Media

Experience from LA Metro indicated that magnetic stripes have a much higher failure rate than “contactless” smartcards—200 times per day compared to 6.7 for smartcards. The publicly known failure rate of magnetic stripe cards has opened the door for fare evasion for passengers who claim that a card is malfunctioning when it is actually out of value. In addition, magnetic stripes on farecards are susceptible to demagnetization or damage.

Despite these drawbacks, magnetic media also carry many advantages. Since they are printed on paper, they are easy to manufacture and can be pre-printed and distributed to vendors or partner agencies without requiring special card-encoding equipment at the vendor sites. Magnetic stripe media can also be dispensed easily at the farebox.

Figure 6-5 | Benefits and Drawbacks of Magnetic Stripe Technology

| Benefits | Drawbacks |
|--|--|
| <ul style="list-style-type: none"> ▪ Collection of basic fare data ▪ Reduces operator interactions/fare enforcement ▪ Reduces cash in system ▪ Accommodates cash (stored value), passes, and transfers (cannot necessarily do all at once on the same card) ▪ Can be purchased pre-loaded (encoded) | <ul style="list-style-type: none"> ▪ Fare media can be damaged/deactivated ▪ Limited uses of fare media (cannot combine passes and stored value on same card) ▪ Reloading can only occur at designated locations (cannot be done automatically) |

Smartcards

Electronic contactless smartcards—a more durable, hard plastic card—have become common at many transit agencies. For customers, smartcards have advantages over magnetic cards, but successful implementation can be challenging. The most significant customer advantage of smartcards compared to magnetic cards is their durability; they can last for several years without replacement. Smartcards can be reloaded with stored cash value or passes and offer the opportunity to provide balance protection,^b increasing security. In addition, the use of smartcards allows more flexible pricing options since transfer costs can be automatically calculated.

From an operational perspective, payment with smartcards is faster than both magnetic stripe payment and cash payment. In addition, since the validation and encoding of a smartcard do not require any mechanical action at the farebox, smartcard systems are frequently more reliable (fewer breakdowns) compared with magnetic stripe fare collection systems.

Despite these benefits, smartcards also present challenges. One significant challenge is the need for elaborate back-end systems to manage accounts and balances. For example, smartcards typically do not come “pre-loaded” and must have value added to them. As a result, smartcards require a network of opportunities to load smartcards including in-person, online, and telephone options. In-person reloading could occur at a fixed-location, an automatic fare reloading station (ticket vending machine), or even at the farebox. Each location requires special hardware to read the smartcard and real-time communications to ensure that the customer’s account can be updated with new balance information. The use of smartcards also necessitates capabilities for potential retail vendors to be able to add value or new fare products to cards.

Figure 6-6 | Smartcard in Atlanta



^b If a smartcard is lost, a customer’s cash balance or pass is not lost. That value or pass can be migrated to a new replacement smartcard.

Figure 6-7 | Benefits and Drawbacks of Smartcards

| Benefits | Drawbacks |
|---|---|
| <ul style="list-style-type: none"> ▪ Enhanced data collection capabilities ▪ User features like "autoload" and "balance protection" ▪ Loading value online or over the telephone ▪ Lower on-board transaction times (reduced dwell times) ▪ Permanence of cards (single card can be used for months) | <ul style="list-style-type: none"> ▪ Higher cost of implementation (back-end systems, value-loading terminals, new equipment, need for on-board vehicle communications equipment) ▪ Greater range of fare options may lead to greater levels of confusion for customers and complexity for agency staff |

Smartphone Payment

Smartphone payment offers an increase in customer convenience over paper or smartcard payment as well as potential operational savings. Smartphone payments eliminate the need for customers to buy and carry a separate card, may reduce delay in fare payment by reducing the use of cash, and may lower maintenance costs by reducing the volume of passes that must be processed. Unlike other fare technology options, smartphone payments require a person to have a linked credit card or banking account, which means that smartphone payment is not an option for customers who rely on cash. Smartphone payment options can serve as a supplement to an existing fare collection system until smartphone ownership is standard. In bus environments, smartphone payments can be accepted in one of three ways, described below.

1. **Flash Pass:** The simplest implementation of smartphone payment is to allow riders to use their phone as a “flash pass” that is validated by the bus operator when they board the bus. This strategy does not require any additional hardware to be installed and can be implemented with few hurdles. The primary drawback is that this method requires additional attention of the operator to visually validate fare media. TriMet in Portland has launched a mobile payment app that uses this system (see Figure 6-8; similar to the flashing of paper passes/tickets). As part of their fare products, transfer media have been eliminated and all cash one-way payments (\$2.50) provide a “2.5 hour” ticket upon fare payment, which can be used for transfers during that time window.

Figure 6-8 | TriMet Flash Pass

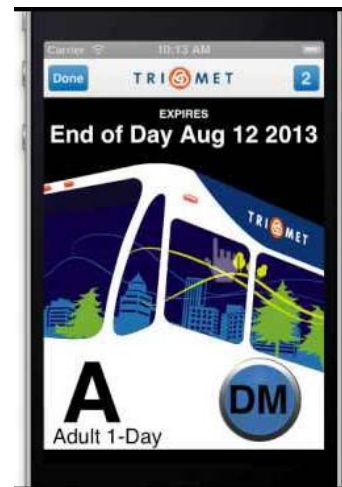

2. **Barcode/Optical Scanners:** A smartphone's large screen provides an opportunity to use barcodes or QR codes to validate fare payment. This approach requires the farebox to use a barcode scanning device (similar to a grocery store checkout counter or an airport scanner reading a boarding pass) to read a smartphone's screen. Barcode readers can read barcodes beyond those on smartphones, including those issued by ticket machines or barcodes printed at home. A fare system using 2-D barcodes can allow both print and mobile payment validation. Optical barcodes also can be scanned by mobile devices for enforcement, and systems can be put in place to update valid barcodes regularly. Currently, Nassau Inter-County Express (NICE) is using in-vehicle optical scanners to validate payments via mobile phone (see Figure 6-9).

Figure 6-9 | NICE In-Vehicle Barcode Scanner

Multi-Format Reader

As part of the fare payment revolution, NICE Bus has installed multifunction readers on the majority of n43 buses.

The readers on these buses accept bar codes embedded in all NICE *gomobile* tickets.

So enjoy the convenience of paying your fare with GoMobile, versus coin and MetroCard payments.



3. **Proximity Validation:** Using a smartphone as a farecard in the U.S. is very rare due to a variety of factors. The Utah Transportation Authority in Salt Lake City is one of the country's leaders in fare technology and just began to accept Apple Pay and Google Wallet in late 2014. Chicago Transit Authority also accepts Apple Pay as of 2015. For many years, different technologies created by smartphone manufacturers have not produced a clear solution that could be included as part of universal fare collection equipment. As a result, many agencies have opted to use simpler ways of validating mobile phone-based fare payment in the interim. Future technologies that support proximity validation include Near-Field Communication (NFC) and Bluetooth Low Energy (BLE).

Figure 6-10 | Benefits and Drawbacks of Smartphone-Enabled Fare Payment

| Benefits | Drawbacks |
|--|--|
| <ul style="list-style-type: none"> ▪ Fare products can be accessed through one's smartphone; there is no need for separate fare distribution outlets ▪ Various means to validate media (visual, scan, proximity) ▪ Customers can purchase fare products at any time and at any location | <ul style="list-style-type: none"> ▪ Visual validation of fare products could add dwell time; however, some studies suggest that flash passes may be faster than processing individual magnetic cards or smartcards ▪ Access issue for those who do not have a smartphone with data plan or a linked credit card/bank account ▪ Need to supplement existing fare payment options (smartcard or magnetic stripe) |

Off-Board Fare Payment

In addition to the specific technology used for fare collection, another important consideration is whether to move payment off of the vehicle and have fare payment take place at machines in bus stops or stations (see Figure 6-11) . Off-board payment can significantly reduce dwell times and speed service. Typically, riders are allowed to board through all doors of the vehicle, which also helps to better distribute passengers within the vehicle. Fare enforcement is conducted either at stations or on board the vehicle. Fare enforcers ask for “proof-of-payment” from customers, which can be inspected visually or by use of equipment that reads smartcards, barcodes, etc. Fare enforcement officials are increasingly using smartphone-based equipment for their work.

Figure 6-11 | Off-board Fare Payment in Manhattan



Connected Vehicles

Another capability that can be very powerful is to have vehicles that are online all the time. In combination with account-based fare systems (discussed below), this real-time communication allows customers to purchase and pay fares through various channels with instantaneous updating of their account balance. Having connected vehicles can facilitate more partnerships with retail vendors and better online account management, since customer payments are immediately available for use on the vehicle. These improved options can speed up transit service by reducing onboard cash transactions and/or card refills.

Connected vehicles can also be used for real-time communications by other onboard systems, including video surveillance, passenger counting, and maintenance sensors. Typically, the vehicles communicate through the cellular network. There are both upfront capital costs and ongoing charges for access to the cell network, but the benefits can make these costs worthwhile. Besides the customer service advantages, the collection and transmission of real-time data can improve transit planning and operations.

Fare Purchase Features and Options

Technology has also allowed many new alternatives for purchasing fares, which can be much more convenient for transit customers. Much of this is related to the choice of fare payment technologies, but purchasing of fares also has its own features and options.

Account-based System

In an account-based system, the customer's account balance is not stored on the fare media itself but in a back-office account. This is a prerequisite for some other features listed below, including regional fare payment processing, full online account management, auto-loading, open payments, and many innovative fare options.

Open Payment Acceptance

Most U.S. transit systems still require payment through fare media issued by the transit agency (usually tickets or cards). However, in addition to the rise in smartphone payments, there has been interest in allowing direct payment by credit card. Pilot programs have been conducted, and the Chicago Transit Authority (CTA) now allows credit card payment for contactless cards only. The main advantage is that customers do not have to carry a separate form of transit payment and can simply use a card or phone that they already carry. These "open payment" systems can also facilitate partnership programs between transit agencies and other merchants.

Ticket Vending Machines

Vending machines (see Figure 6-12 for an example) are commonly used to provide another means of purchasing fares. They are most often placed on the transit agency's property, such as at transfer centers. However, many agencies have agreements to place ticket vending machines on other public property, including sidewalks. Some vending machines are found in private institutions, especially stadiums, museums, or other places with many visitors. The machines require power and communications as well as some weather protection, but nevertheless can be installed in diverse environments.

Figure 6-12 | Ticket Vending Machine in Dallas



Retail Partners

As is already the case in Lawrence, many cities have retailers that sell transit agency fare products. Sometimes the retailer receives a commission, although many merchants are willing to participate for reduced commissions since transit customers can bring new walk-up business. Typically, these retail partners already handle cash and have longer hours and can include check cashers, grocery stores, and pharmacies, such as Dillons and Hy-Vee which already sell transit products in Lawrence. As mentioned above, having an account-based system and connected vehicles can enhance the value of retail partners, since payments will be instantaneously available for use on any vehicle.

Online Account Management

Allowing customers to make payments online, register their accounts for balance protection, review their account and usage history, and print their own transaction receipts are some of the features that transit riders appreciate. These features can attract new riders, since they alleviate the need for many transactions during the transit journey and also make reimbursement of business expenses easier. Many existing and potential transit riders are accustomed to managing their accounts online for other goods and services.

Auto-loading

An account-based system also enables the possibility of auto-loading. Customers can automatically renew their time-based passes or automatically refill their stored-value account balance. This requires a person to link the transit account to a credit or debit card, but many people appreciate the convenience. Auto-loading often reduces onboard transactions, and therefore improves service as well.

ADA PARATRANSIT (T LIFT) ELIGIBILITY

An emerging trend, especially with larger transit systems, is to shift the ADA paratransit eligibility process to an in-person assessment. This process typically replaces a certification from the individual customer's medical provider, who may not always be familiar with the accessibility status of transit vehicles and facilities, or the functionality required for using fixed-route transit. The in-person assessment helps to ensure that the paratransit service is available for those who truly need it.

In addition, many transit systems, as is the case in Lawrence, offer fixed-route discounts to those who are certified for ADA paratransit eligibility. The intent is to incentivize those eligible individuals to use the fixed-route system when possible. However, it can lead to people applying for ADA certification solely to receive the fixed-route discount, with no real intent of using the paratransit service. A more rigorous ADA eligibility process can alleviate these concerns as well.

The eligibility process is typically outsourced to specialized vendors when using in-person assessment. Trained evaluators then test each applicant's functionality in a facility designed for this purpose. Typically, each individual is required to recertify at selected intervals such as every three years, although it is possible to exempt certain people if desired (e.g. those who have a very small chance of physical improvement). This type of eligibility evaluation often leads to more applicants being diverted to travel training, which assists with learning how to use the fixed-route system successfully. Another outcome is often that people are certified for conditional eligibility – they can use ADA paratransit for certain trips depending on origin/destination, weather conditions, health status, etc. In addition to ensuring that agency resources for paratransit are used wisely, the in-person assessment can allow more people to use the fixed-route system, and therefore increase independence and flexibility for many people with disabilities.

An RFP process for a vendor to handle paratransit eligibility typically includes evaluation of at least the following items:

- In-person eligibility assessments (physical, cognitive and/or visual evaluations as needed) of applicants for paratransit service
- Written determinations regarding each applicant's paratransit eligibility
- Notification of eligibility status to applicants
- Identification of potential travel training candidates
- Documentation of eligibility determinations for use in the paratransit eligibility administrative appeals process
- Coordination of data with agency software to monitor trends and volume of applications
- Preparation of a variety of reports to document the activity of the in-person process

POTENTIAL CHANGE TO FARE-FREE SYSTEM

Given the relatively low percentage of operating expenses which are funded by passenger fares (not counting university fees) in Lawrence, as well as the costs to collect those fares, there is the potential to eliminate fares altogether.

A completely fare-free system would have some benefits, including:

- Reduced dwell times for buses, although this may be minimal since all-door boarding is not expected to be implemented due to safety concerns
- Increased ridership
- Simplified administration with no need for cash control
- Some reduced conflict between bus operators and passengers
- Favorable perception that agency is supporting sustainability and economic growth
- No need for capital investments to upgrade fareboxes

However, these benefits would also come with new challenges if fares were completely eliminated, such as:

- Loss of net revenue even with reduced admin costs
- Unfavorable perception that passengers are not contributing to cost
- Possible increase in passengers using bus for shelter or other non-transportation reasons
- Fixed-route service would likely need to increase due to crowding, and additional paratransit service would be needed as well

An alternative to a fare-free system would be to gradually increase fares. The current \$1.00 regular fare for fixed-route service is low compared to most peers. While sudden large increases are very disruptive to customers, it may be possible to raise the fare by 25 cents every 2 years. Figure 6-13 compares existing funding with these two alternatives for Year 4, for the Coordinated System of both Lawrence Transit and KUOW. The assumptions for each are as discussed below.

Existing Revenues and Expenses:

- **Ridership:** Same as existing.
- **Fares:** Remain the same at \$1.00 for fixed-route, \$2.00 paratransit.
- **University Fees:** Remain the same as existing.
- **Federal Operating Revenue:** Remains the same as existing.
- **State Operating Revenue:** Remains the same as existing.
- **Local Operating Revenue:** Remains the same as existing.
- **Operating Expenses:** Remains the same as existing.
- **Capital Expenses Related to Fares:** None.

Fare-Free System:

- **Ridership:** Increased by 25 percent, based on TCRP research and other agency experience.
- **Fares:** None.
- **University Fees:** Remain the same as existing.
- **Federal Operating Revenue:** Remains the same as existing, since formula for small UZAs is related to population and density only.

- **State Operating Revenue:** Increased by 12 percent based on formula (10 percent increase for more ridership, 2 percent increase for more service).
- **Local Operating Revenue:** Remains the same as existing.
- **Operating Expenses:** Increased by 8 percent (10 percent increase for more service less 2 percent decrease for reduced administrative and maintenance costs).
- **Capital Expenses Related to Fares:** None.

Increased Fares:

- **Ridership:** Decreased by 15 percent, based on Simpson-Curtin rule and other research, as well as industry knowledge.
- **Fares:** Average fare increased by 50 percent, less fares forgone from ridership loss.
- **University Fees:** Remain the same as existing.
- **Federal Operating Revenue:** Remains the same as existing, since formula for small UZAs is related to population and density only.
- **State Operating Revenue:** Decreased by 6 percent based on formula due to less ridership.
- **Local Operating Revenue:** Remains the same as existing.
- **Operating Expenses:** Increased by 4 percent for better audit, revenue control, payment options, and farebox maintenance.
- **Capital Expenses Related to Fares:** \$750K for new fareboxes and related expenses.

Figure 6-13 | Annual Ridership, Revenue, and Expense of Fare-Free System and Fare Increase (Estimated)

| Category | Existing | Fare-Free System Year 4 | 50% Fare Increase Year 4 |
|---------------------|----------|-------------------------|--------------------------|
| Ridership | 3.1M | 3.9M | 2.6M |
| Fare Revenue | \$0.40M | \$0 | \$0.51M |
| University Fees | \$2.80M | \$2.80M | \$2.80M |
| Federal Revenue | \$2.10M | \$2.10M | \$2.10M |
| State Revenue | \$0.50M | \$0.56M | \$0.47M |
| Local Revenue | \$2.30M | \$2.30M | \$2.30M |
| Total Revenue | \$8.10M | \$7.80M | \$8.20M |
| Operating Expense | \$8.10M | \$8.70M | \$8.40M |
| Net Surplus/Deficit | \$0 | (\$0.90M) | (\$0.20M) |
| | | | |
| Capital Expense | \$0 | \$0 | \$0.75M |

The existing system shows a balance for revenues and expenses, but assumes that no upgrades are made to the current procedures for audit and revenue control. For the fare-free system, the projected deficit could be made up by reducing service, new revenue sources, more funding from the existing sources, or some combination of those. The projected deficit is less if fare collection is maintained and fares are increased.

RECOMMENDATIONS

Fares

Most of the peer systems provide fare-free services for university students, staff, and faculty with the university providing funding to take the place of the revenue that a public transit system would otherwise collect from passengers. Some of the peers, including Chapel Hill and Missoula, provide an entirely fare-free system for all passengers, with the farebox revenues replaced with funding from a variety of sources, including local, state or federal funds, or partnerships. For systems that are not fare free, fares ranged from \$0.50 to \$1.75 per ride.

Due to the uncertainty of other existing funding sources for Lawrence Transit and KUOW, as well as the fact that mechanisms for fare collection are already established, it is recommended that the existing system of fare collection be continued. The University should continue to fund trips taken by its affiliates. For Lawrence Transit routes, improvements to fare collection should be considered as payment technology continues to mature. Alternatively, the decision about whether to eliminate fares could be discussed as part of the upcoming sales tax extension. This would reduce the reliance on state and federal funding, since those revenue streams are subject to political forces and more uncertain for the future.

Procedures and Technology

It is recommended that Lawrence Transit strengthen their revenue control and audit procedures, both by contracting with a specialized cash management vendor and by increasing staff time devoted to auditing.

Regarding fare payment technology, the smartphone revolution has allowed much more convenient fare purchase and payment at relatively little cost. A promising approach for Lawrence Transit would be to allow mobile phone payment by visual inspection from bus operators, as is done in Portland, OR through the vendor moovel.

Finally, consideration should be given to creating an in-person assessment for T Lift eligibility, instead of the current medical provider certification. Although not all peers are currently doing this, in-person assessments are emerging nationwide as a best practice. This helps to ensure that the ADA paratransit service is reserved for those who truly need it, and that any fixed-route discounts given to individuals who are eligible for T Lift are legitimate. This process can also divert more people to the fixed-route system, allowing individuals with disabilities more freedom and flexibility for travel.

Governance

All the peer communities interviewed had some type of formalized agreement in place to detail the operating agreement and cost sharing methodology between the university and the transit system. In Ames, the agreement also included a role for university students on the board, distinct from the university staff. These agreements generally specify:

- The approach to determining the level of university funding for transit;
- The frequency, duration, and service quality of services provided by the transit agency;
- Details on shared assets, such as vehicles, maintenance yards, and/or transit center; and
- A process for making decisions about service funding, fares, and routes.

For both KU and the City, there are good reasons to, and not to, consolidate. On the positive side, a consolidated system would streamline federal and state reporting requirements. Consolidation would also allow a single service contract, although an agreement for joint procurement of operations and maintenance already exists and so this would not provide any financial efficiency. Full consolidation into one system has the disadvantage of needing to figure out how to address the facilities and bus sharing agreements that remain in effect today, as well as how to transfer assets to a consolidated agency.

Uniting into one public transit agency also brings with it the responsibility for increased ADA paratransit service. Although the university currently provides JayLift service on its campus, it is not mandated under ADA, and therefore has less stringent requirements for driver training, vehicle specifications, reporting, and customer response. Changing JayLift to ADA paratransit is possible and may have some customer benefits but would likely reduce some management flexibility and increase costs. Consolidation could also include greater coordination with Independence, Inc. which provides on-demand services for persons with disabilities in Lawrence.

Over the course of time, Lawrence Transit and the University of Kansas have done a good job of coordinating and sharing capital assets as evidenced by the existing agreements. At this time, it is not recommended to pursue a full consolidation, but instead to secure long-term commitments for funding. At that point, an analysis of positives and negatives of full consolidation, including the effect on federal and state funding should be undertaken. Meanwhile, the existing MOUs should be updated, particularly with regard to a potential new transit center. More detail can be added about routing/scheduling decisions, revenue and cost sharing, joint procurement, marketing/branding, and asset management, if desired.

If a consolidated system were desired in the future, a new governance structure would be required to manage the system. As noted in a recent KU research paper, transit governance models come in numerous forms, most of which correspond to one of the following six models:⁸

- regional transit authority,
- regional transit coordinating council,
- joint powers agreement,
- joint power board,
- private not-for-profit agency as lead agency which contracts for service, and
- private stock corporation.

It is recommended to form a joint powers authority to run the system. The board setup should be similar to what is done in Ames, IA, which has operated successfully for many years. This arrangement helps insulate the system from the natural political swings of the City and the University to a large degree and offers a stable relationship with shared control.

In Kansas, the regional transit authority (RTA) model is only allowed to be formed in two communities, Wichita and Topeka, or communities where there is already an established and well-received municipal or county-run public transportation provider which possesses (by way of its existing governing authority) the ability to tax or issue bonds as a financing mechanism.^c This

^c Wichita is authorized to operate a transit system because its population is larger than 225,000. K.S.A. 13-3101 through 13-3116 allows first-class cities with such a population to create and operate a transit system provided that “privately owned public transportation [is] inadequate” and that voters approve of the creation of a system. Topeka is authorized is expressly authorized by K.S.A. 12-2801 through 12-2840. The “metropolitan transit authority act” which authorized the City of Topeka to hold a referendum on the creation of a transit authority.

way, the creation of the RTA is seen as a lateral transfer of pre-existing taxes, not the creation of new taxes. Therefore, forming an RTA in Lawrence would require action by the State Legislature to then allow the City to vote on the formation.

Funding

In many places, governance documents establish a methodology for determining the annual university cost sharing. There are several approaches Lawrence peer communities have taken to do this:

- **Determine Route “Ownership”:** As Lawrence is currently doing, some cities have established City, University, and Coordinated routes, each with its own operating costs. The university pays for the operating costs of routes primarily serving campus and a predetermined share of the cost of operating the coordinated routes. This is also the arrangement in Chapel Hill, NC. The benefit of this approach is greater budget transparency about what the university is paying for and who is responsible for funding service improvements. However, this arrangement can hinder efforts to expand transit services and achieve greater synergies between university, shopping, and business destinations.
- **Pre-determined Set Amount:** In Normal, the University pays the City a pre-determined amount each year to support transit agency operations. The benefit of this approach is that the transit agency can do multiyear budgeting. The system uses data on ridership to monitor student operating costs and validate or adjust the annual funding levels. A challenge to this approach is that it can limit transportation demand management efforts at the University as there is little benefit to them if student transit ridership goes up or down.
- **Fee per Student Enrollment:** In Ames, the University pays the City an amount per student rate based on the number of students enrolled at the campus, as well as an additional predetermined amount for faculty and staff. Again, the transit system uses ridership data to track the operating costs needed to serve students in order to ensure the funding matches actual costs. The benefit to this approach is that as student enrollment increases, the transit agency receives a larger amount of funding.
- **Ridership Levels:** Instead of using student ridership data to validate the level of University funding for transit, some cities track students, faculty, and staff that ride transit, and “charge” the University for their fares. The challenges with this approach are that it limits the proactive collaboration between the university and the transit system.

Other sources of funding to support the implementation of either of the recommended service scenarios would include Lawrence Transit’s current primary sources of federal, state, and local operating funds:

- Federal: Section 5307 Urbanized Area Formula Grants
- Federal: Section 5310 Enhanced Mobility of Seniors & Individuals with Disabilities
- State: KDOT
- Local: Sales Tax Revenues
- Local: University Cost Share
- Farebox Revenue

Implementation of the service recommendations should not require additional operating funding by Lawrence Transit or KUOW. However, recent changes in federal transportation funding as well as state funding could require changes to the current funding mix in the medium-term. The following matrix provides a summary of the current funding for Lawrence Transit, match considerations, and opportunities. Further detail on each program or funding type follows.

Figure 6-14 | Matrix of Funding Opportunities

| Funding Source | Type | Local Match Requirements | Future Outlook |
|----------------------|---------|--------------------------|-------------------------------------|
| Section 5307 Program | Federal | 20% | Authorized in FAST Act through 2020 |
| Section 5339 Program | Federal | 20% | Authorized in FAST Act through 2020 |
| Section 5310 Program | Federal | 20% | Authorized in FAST Act through 2020 |
| T-Works Program | State | None | Funded through 2018 |
| Sales Tax | Local | - | Approved through 2018 |

Federal Transit Programs

KDOT administers public transportation programs funded by the Federal Transit Administration and the State of Kansas. Both the Federal and State programs are designed to meet the transportation needs of elderly persons, persons with disabilities, and the general public.

The Section 5307 program is the primary federal funding program for transit in communities with more than 50,000 people. It provides a flexible source of funding, able to be used for a wide range of transit operating activities, including: planning, engineering, design and transportation-related studies; capital investments in bus and bus-related activities such as replacement, overhaul and rebuilding of buses, crime prevention and security equipment, and construction of maintenance and passenger facilities; and capital investments in new and existing fixed guideway systems including rolling stock, overhaul and rebuilding of vehicles, track, signals, communications, and computer hardware and software. In addition, associated transit improvements and certain expenses associated with mobility management programs are eligible under the program. Because Lawrence has a population less than 200,000, operating assistance is an eligible expense.

Federal funding under this program flows to Lawrence Transit through KDOT. Funding is apportioned on the basis of legislative formulas. For areas of 50,000 to 199,999 in population, the formula is based on population and population density. There is a non-federal matching requirement. The federal share is not to exceed 80 percent of the net project cost for capital expenditures. The federal share may be 90 percent for the cost of vehicle-related equipment attributable to compliance with the Americans with Disabilities Act and the Clean Air Act. The federal share may not exceed 50 percent of the net project cost of operating assistance.

In addition, the Section 5339 program, as modified by the FAST Act, is another potential source of increased funding for Lawrence Transit’s upcoming vehicle replacements and other capital projects. Under MAP-21, the program provided formula funds only, which relieved the inconsistency and uncertainty for transit providers of the predecessor 5339 discretionary program, but also decreased the former program’s flexibility. Changes to the program under the FAST Act include:

- Increased funding for the program overall, from the MAP-21 level of \$428 million in FFY15 to \$809 million in FFY20,

- Authorization of a higher level of annual funding for states to use in non-urbanized areas, from \$1.25 million to \$1.75 million per year, and
- Introduction of two new competitive programs for states and local transit agencies, which will provide funding in the amount of \$1.5 billion over five years.

One competitive program will use \$213 million to \$289 million annually to fund projects to replace, rehab, purchase, or lease buses on the basis of age and condition, or purchase, construct, or lease bus facilities. The other will provide \$55 million per year to support the acquisition of low- or zero-emission vehicles and related facility projects. Ten percent of the competitive funding amounts will be set aside for projects in rural areas.

Finally, the Section 5310 program provides formula funding to states for the purpose of assisting private nonprofit groups in meeting the transportation needs of older adults and people with disabilities.

Sources of Nonfederal Matching Funds

The nonfederal share of capital projects may be obtained from eligible state and/or local sources. While the FAST Act authorizes funding from the Highway Trust Fund through 2020, some federal transit programs are not authorized and in the longer term, federal transit funding prospects remain unclear. The availability of local funding from sales tax revenues and local partners like the University of Kansas acts as a buffer against future federal funding volatility, while also providing a stable source of local matching funds in the short term.

Since 2008, Lawrence Transit has benefitted from two sales taxes for transit. One is a 0.20 percent sales tax to sustain existing services, while the second is a 0.05 percent sale tax to fund new services. Both of these taxes are set to expire at the end of 2018.

At the state level, the T-Works program provides another source of non-federal funding. In May 2010, the Kansas Legislature passed Transportation Works for Kansas (T-Works), an \$8 billion 10-year transportation program funded primarily through a 4/10 cent sales tax. The program is designed to create jobs, preserve highway infrastructure, and provide multimodal economic development opportunities across the state.

With this funding, the Kansas Department of Transportation provides \$825K in discretionary funding to projects that will increase public transportation options and usage. Transit agencies are provided funding through the following formula:

- 40 percent is a 3 year floating average of ridership;
- 40 percent based on population; and
- 20 percent from revenue miles.

Lawrence Transit included the University routes and revenues in its reporting for T-Works funding calculations.

Summary of Recommendations

Currently, both Lawrence Transit and KUOW have somewhat unstable funding sources. Since the local sales tax needs to be renewed by voters in 2018, and the student fees need to be renewed annually by KU students, this uncertainty limits multi-year planning for the transit system. With the future of federal and state funding also somewhat unclear, it is recommended that efforts be directed to securing local funding. Some suggested steps are as follows:

- Have the University of Kansas set a floor on the student fees, with additional funds being discretionary; possibly increase the price of on-campus parking to fund this.
 - Funding floor can especially help with predictability of funding availability for capital projects.
 - University fees should be transitioned into an administration-controlled fee, rather than a student senate-controlled fee in order to provide more funding stability.
 - University fees should include an automatic escalator to account for inflation.
- Show local voters a compelling combined service plan, including the recommendations from this study, and market the improvements which will be possible with the renewed sales tax.
- Similarly, make the case to voters about the importance of funding the new transit center, including the value of the federal funds being leveraged.
- Update MOUs between Lawrence Transit and KU. This could include the following modifications:
 - Update to reflect any new funding sources, including sales tax extension and/or changes to University fees; and any new major capital investments such as a new transit center.
 - Separate MOUs for fare/operational agreements, and capital agreements; add buy-out terms to capital agreement to ensure equitable terms of separation (if necessary).
- Gradually raise fares and institute in-person assessment for T Lift eligibility.
- Increase resources for audit and revenue control, using in-house staff and contracting with a cash management vendor.
- Continue with current model of collaboration which works well, no need for a fully consolidated RTA at this time.

7 REFERENCES

¹ Multimodal Planning Studies: Fixed Route Transit and Pedestrian Accessibility Study, December 2013. <https://assets.lawrenceks.org/assets/mpo/study/reports/transit.pdf>

² Retiree Attraction and Retention Task Force Final Report, June 2012. https://assets.lawrenceks.org/assets/boards/ratf/ss_retiree_attraction_task_force_final_report.pdf

³ Rockefeller Millennials Survey, April 2014. <http://t4america.org/wp-content/uploads/2014/04/RF-Millennials-Survey-Topline.pdf>

⁴ Amenities Guidelines and Policies for Lawrence Transit, July 2015. https://assets.lawrenceks.org/assets/agendas/cc/2015/07-21-15/pt_transit_amenities_guidelines.pdf

⁵ Multimodal Planning Studies, March 2014. <https://lawrenceks.org/mpo/study/>

⁶ Fixed Route Transit and Pedestrian Accessibility Study, December 2013. <https://assets.lawrenceks.org/assets/mpo/study/reports/transit.pdf>

⁷ Lawrence Bicycle Parking and Amenities Policy Review, November 2016. <https://assets.lawrenceks.org/assets/mpo/bicycle/BikeParkInvRecommendations-2016.pdf>

⁸ Baker, Matt and Pat Weaver. *Governance Models for Regional Transit Coordination*, University of Kansas Transportation Center, November 5, 2010. http://www2.ku.edu/~kutc/pdffiles/KDOT_Regional_Transit_Pilot_Study/11-05-10-KUTCGovernanceModelsWhitePaper.pdf